

SP A, SP

Submersible pumps, motors and accessories

50 Hz



be
think
innovate

GRUNDFOS 

1. General description	3	8. Electrical accessories	94
Performance range	3	CUE frequency converter	96
Minimum efficiency index	4	CIU communication interface units	98
Type key	5	Motor starters for CSIR/CSCR	100
Applications	6	PR 5714 with Pt100 sensor	101
Pump range	6	MS motor cables	103
Motor range	6	Submersible drop cable	105
		Cable clips	105
2. Submersible pumps	7	Cable termination kit with plug	105
Features and benefits	7	Cable termination kit, type KM	106
Material specification (SP 1A - SP 5A)	9	Mastik for flat cables	106
Material specification (SP 7 - SP 14)	10	Cable termination kit, types M0 to M4	107
Material specification (SP 17 - SP 60)	11		
Material specification (SP 77 - SP 215)	12	9. Mechanical accessories	108
		Connecting pieces	108
3. Submersible motors	13	Zinc anodes	110
Features and benefits	13	Flow sleeves	110
Shaft seal	15		
Material specification for MS motors	16	10. Energy consumption	111
Material specification for MMS motors	17	Energy consumption of submersible pumps	111
4. Operating conditions	18	11. Cable sizing	112
Inlet pressure	18	Cables	112
Minimum flow rate	18	Sizing of cable	114
Maximum flow rate	18	Calculation of the power loss	114
Pumped liquids	18		
Liquid temperature	18	12. Table of head losses	115
Maximum operating pressure	18	Head losses in ordinary water pipes	115
Maximum start/stop frequency	19	Head losses in plastic pipes	116
Recommended minimum borehole diameter	20		
		13. Grundfos Product Center	117
5. SP NE, SP A NE environmental pumps	21		
Material specification SP NE, SPA NE pumps	22		
How to read the curve charts	23		
Curve conditions	23		
6. Performance curves and technical data	24		
SP 1A	24		
SP 2A	26		
SP 3A	28		
SP 5A	30		
SP 7	32		
SP 9	35		
SP 11	38		
SP 14	41		
SP 17	44		
SP 30	49		
SP 46	54		
SP 60	59		
SP 77	64		
SP 95	69		
SP 125	74		
SP 160	79		
SP 215	84		
7. Electrical data	89		
1 x 230 V, submersible motors "MS"	89		
3 x 230 V, submersible motors "MS"	89		
3 x 230 V, submersible rewindable motors "MMS"	90		
3 x 400 V, submersible motors "MS"	90		
3 x 400 V, submersible motors "MS T60" (60 °C)	91		
3 x 400 V, submersible rewindable motors "MMS"	91		
3 x 500 V, submersible motors "MS"	92		
3 x 500 V, submersible motors "MS T60"	92		
3 x 500 V, submersible rewindable motors "MMS"	93		

1. General description

Performance range

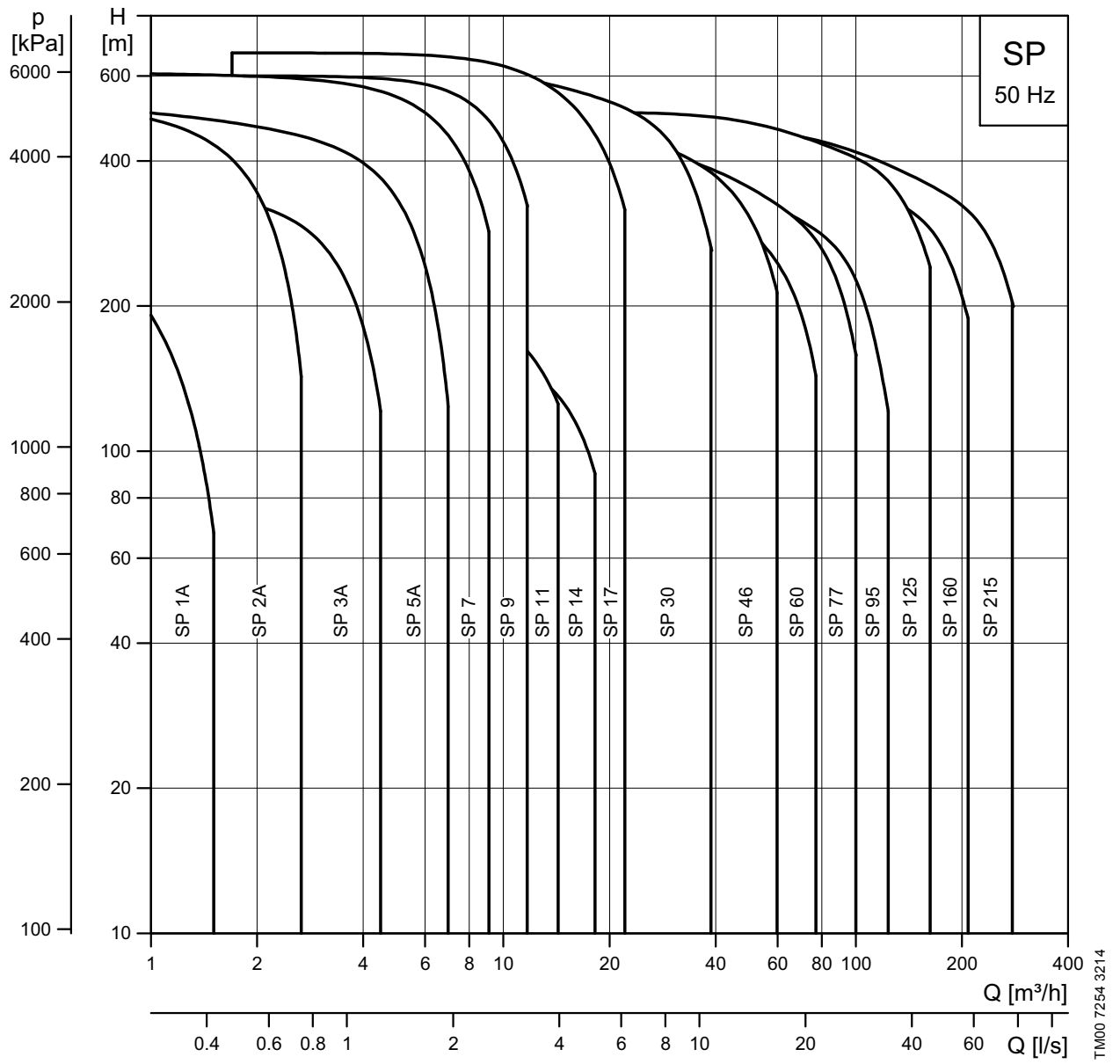

ErP ready

The SP A, SP 4" and 6" pumps are energy-optimised and comply with the ErP Directive (Commission Regulation (EC) No 547/2012) which has been effective as from 1 January 2013. As from this date, all pumps are classified/graduated in a new energy efficiency index (MEI).

Minimum efficiency index

Minimum efficiency index (MEI) means the dimensionless scale unit for hydraulic pump efficiency at best efficiency point (BEP), part load (PL) and overload (OL). The Commission Regulation (EU) sets efficiency requirements to $MEI \geq 0.10$ as from 1 January 2013 and $MEI \geq 0.40$ as from 1 January 2015. An indicative benchmark for best-performing water pump available on the market as from 1 January 2013 is determined in the Regulation.

- The benchmark for most efficient water pumps is $MEI \geq 0.70$.
- The efficiency of a pump with a trimmed impeller is usually lower than that of a pump with the full impeller diameter. The trimming of the impeller will adapt the pump to a fixed duty point, leading to reduced energy consumption. The minimum efficiency index (MEI) is based on the full impeller diameter.
- The operation of this water pump with variable duty points may be more efficient and economic when controlled, for example, by the use of a variable-speed drive that matches the pump duty to the system.
- Information on benchmark efficiency is available at <http://europump.eu/efficiencycharts>.

Efficiency and MEI index for SP pumps

Pump type	Pump size	Efficiency [%]	MEI
SP 1A	4"	39	≥ 0.70
SP 2A	4"	50	≥ 0.70
SP 3A	4"	58	≥ 0.70
SP 5A	4"	60	≥ 0.56
SP 7	4"	69	≥ 0.70
SP 9	4"	71	≥ 0.70
SP 11	4"	70	≥ 0.55
SP 14	4"	70	≥ 0.44
SP 17	6"	74	≥ 0.70
SP 30	6"	75	≥ 0.50
SP 46	6"	76	≥ 0.50
SP 60	6"	77	≥ 0.60
SP 77	8"	78	-
SP 95	8"	79	-
SP 125	10"	79	-
SP 160	10"	80	-
SP 215	10"	83	-

Type key

Example of pump	SP 46	- 9 C	L	Rp4	6"		50/60	SD		
Example of pump with motor	SP 125	- 10 AA N		Rp6	8"	3 x 380-415	50	SD	92 kW	
Type range (SPXA, SP)										
Number of impellers										
Reduced impellers (A, B, C max. 2)										
Stainless-steel parts of material										
= EN 1.4301										
N = EN 1.4401										
R = EN 1.4539										
Rubber parts of material										
SP 1A - SP 5A	SP 9 - SP 14	SP 17 - SP 215								
= NBR	= LSR/NBR/TPU	= NBR								
E = FKM	E = FKM	E = FKM								
		L = LSR/NBR								
Connection										
Rp thread (PpX)										
R thread (RX)										
NPT thread (XNPT)										
Grundfos flange (GrX)										
Inlet motor size										
Voltage [V]										
Frequency [Hz]										
Starting method										
S = DOL										
D = SD										
Motor power [kW]										

Applications

SP pumps are primarily used for pumping of raw water from the underground. The pumps are installed in boreholes or wells, submerged below the water level. For industrial purposes you can place the pump in e.g. a tank.

The SP A and SP pumps are suitable for the following applications:

- raw-water supply
- irrigation
- groundwater lowering
- pressure boosting
- fountain applications
- mining applications
- off-shore applications.

Pump range

Type	Steel EN 1.4301	Steel: (N) EN 1.4401	Steel (R) EN 1.4539	Connection*	Flange connection Grundfos flange
SP 1A	•			Rp 1 1/4	
SP 2A	•			Rp 1 1/4 (R 1 1/4)	
SP 3A	•	•		Rp 1 1/4	
SP 5A	•	•	•	Rp 1 1/2 (R 1 1/2)	
SP 7	•	•	•	Rp 1 1/2 (R 1 1/2)	
SP 9	•	•	•	Rp 2 (R 2)	
SP 11	•	•	•	Rp 2	
SP 14A	•	•	•	Rp 2	
SP 17	•	•	•	Rp 2 1/2 (R 3)	
SP 30	•	•	•	Rp 3 (R 3)	
SP 46	•	•	•	Rp 3 Rp 4 (R 4)	
SP 60	•	•	•	Rp 3 Rp 4	
SP 77	•	•	•	Rp 5	5"
SP 95	•	•	•	Rp 5	5"
SP 125	•	•	•	Rp 6	6"
SP 160	•	•	•	Rp 6	6"
SP 215	•	•	•	Rp 6	6"

* Figures in brackets () indicate connection for pumps with sleeve.

Motor range

Motor output [kW]	0.37	0.55	0.75	1.1	1.5	2.2	3.0	3.7	4.0	5.5	7.5	9.2	11	13	15	18.5	22	26	30	37	45	55	63	75	92	110	132	147	170	190	220	250			
MS 402	•	•	•	•	•	•																													
MS 4000 (R)			•	•	•	•	•	•	•	•	•	•	•																						
MS 4000I (R)						•	•	•	•	•	•	•																							
MS 6000 (R)										•	•	•	•	•	•	•	•	•	•	•	•	•	•	•	•	•									
MS 6000I (R)										•	•	•	•	•	•	•	•	•	•	•	•	•	•	•	•	•									
MMS 6 (N, R)										•	•	•	•	•	•	•	•	•	•	•	•	•	•	•	•	•									
MMS 8000 (N, R)																•	•	•	•	•	•	•	•	•	•	•	•	•	•	•	•	•	•		
MMS 10000 (N, R)																									•	•	•	•	•	•	•	•	•		
MMS 12000 (N)																																•	•	•	•

We recommend that you use soft starter or autotransformer above 75 kW.

Motors with star-delta starting are available from 5.5 kW.

MS 4000 and MS 6000 are available with a built-in temperature transmitter (Tempcon).

2. Submersible pumps

Features and benefits

A wide pump range

Grundfos offers energy-efficient submersible pumps ranging from 1 to 280 m³/h. The pump range consists of many pump sizes, and each pump size is available with an optional number of stages to match any duty point.

High pump efficiency

Often pump efficiency is a neglected factor compared to the price. However, the observant user will notice that price variations are without importance to water supply economics compared to the importance of pump and motor efficiencies.

Example

When pumping 200 m³/h at a head of 100 m for a period of 10 years, a normal pump consumes about 688,000 kWh. If the pump/motor efficiency is enhanced by 5 %, you can save about 34,000 EUR in energy cost, as if the price is EUR 0.10/kWh.

Material and pumped liquids

To ensure the right wear resistance and reduce risk of corrosion the pump ranges are available with different steel variants.

- **SP:** EN 1.4301
- **SP N:** EN 1.4401
- **SP R:** EN 1.4539

See specified material variants in [Pump range](#) on page 6. For further protection to corrosive environments, a complete range of zinc anodes for cathodic protection is available. See page 105.

Rubber components

For pumping liquid with risk of chemical residue, or liquids > 60 °C, all pumps can be delivered with rubber components made of FKM elastomer.

Low installation costs

Stainless steel means low weight facilitating the handling of pumps and resulting in low equipment costs and reduced installation and service time.

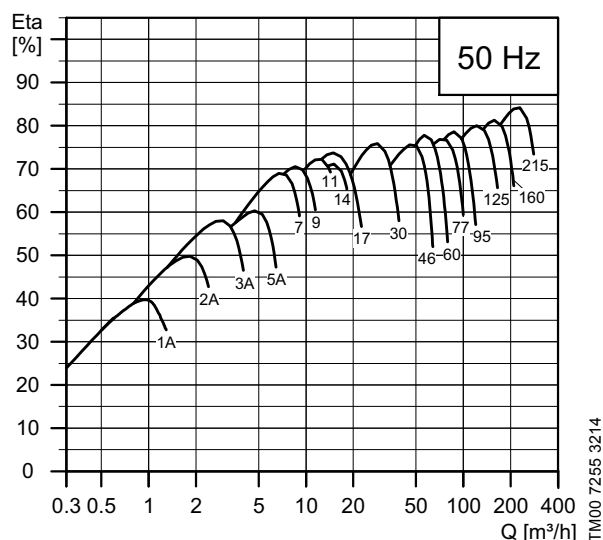

Fig. 1 Pump/motor efficiencies in relation to flow



Fig. 2 Various SP pumps

TM00 7255 3214

TM061385 2314

Bearings with sand channels

All bearings are water-lubricated and have a squared shape enabling sand particles, if any, to leave the pump together with the pumped liquid.

Inlet strainer

The inlet strainer prevents particles over a certain size from entering the pump.

Non-return valve

All pumps have a reliable non-return valve in the valve casing preventing backflow in connection with pump stoppage.

Furthermore, the short closing time of the non-return valve means that the risk of destructive water hammer is reduced to a minimum.

The valve casing is designed for optimum hydraulic properties to minimise the pressure loss across the valve and thus to contribute to the high efficiency of the pump.

Priming screw

All Grundfos pumps with radial impellers are fitted with a priming screw. Consequently, dry running is prevented because the priming screw will ensure that the pump bearings are always lubricated.

SP pumps with semi-axial impellers require no priming screw. The pumps are primed automatically.

It applies to all pump types, however, neither pump nor motor will be protected against dry running if the water table is lowered to a level below the pump inlet.

Stop ring

The stop ring prevents damage to the pump during transport and in case of upthrust in connection with startup.

The stop ring, which is designed as a thrust bearing, limits axial movements of the pump shaft.

The stationary part of the stop ring (A) is secured in the upper chamber.

The rotating part (B) is fitted above the split cone (C).

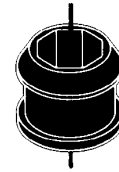

Fig. 3 Bearing

TM00 7301 1096

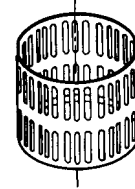

Fig. 4 Inlet strainer

TM00 7302 1096

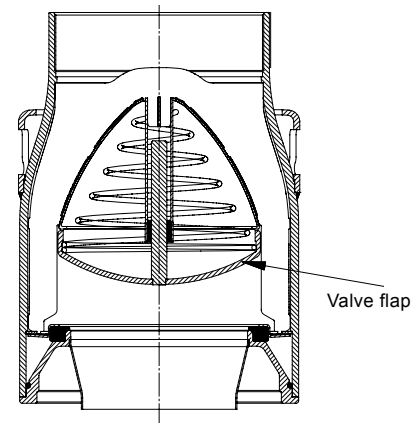

Fig. 5 Non-return valve

TM01 2499 1798

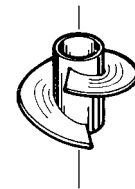

Fig. 6 Priming screw

TM00 7304 1096

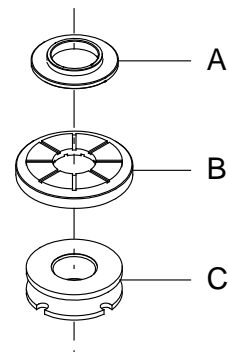

Fig. 7 Stop ring (rotating and stationary parts) and split cone

TM01 3327 3898

Material specification (SP 1A - SP 5A)

Pos.	Component	Material	Standard	N-version	R-version
			EN		
1	Valve casing	Stainless steel	1.4301	1.4401	1.4539
2	Valve cup	Stainless steel	1.4301	1.4401	1.4539
3	Valve seat	Rubber type	NBR	NBR-FKM	NBR-FKM
7	Neck ring	NBR/TPU			
8	Bearing	NBR			
	Washer for stop ring	Carbon/graphite HY22 in PTFE mass			
9	Chamber	Stainless steel	1.4301	1.4401	1.4539
12	Impeller	Stainless steel	1.4301	1.4401	1.4539
14	Suction interconnector	Cast stainless steel	1.4308	1.4408	1.4517
	Strainer	Stainless steel	1.4301	1.4401	1.4539
16	Shaft complete	Stainless steel	1.4057	1.4460	1.4462
17	Strap	Stainless steel	1.4301	1.4401	1.4539
18	Cable guard	Stainless steel	1.4301	1.4401	1.4539

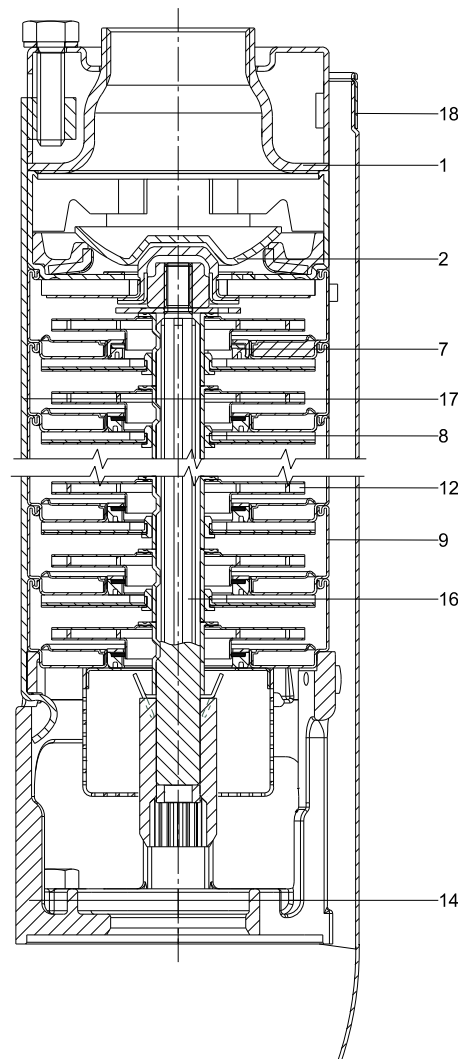

Fig. 8 Example SP3A, pump with spline shaft.

TM06 93 1614

Material specification (SP 7 - SP 14)

Pos.	Component	Material	EN		
			Standard	N-version	R-version
1	Valve casing	Cast stainless steel	1.4301	1.4401	1.4539
2	Valve cup	Cast stainless steel	1.4301	1.4401	1.4539
3	Valve seat	NBR-FKM	NBR-FKM	NBR-FKM	NBR-FKM
7	Neck ring	TPU/PPS-FKM	TPU/PPS-FKM	TPU/PPS-FKM	TPU/PPS-FKM
8	Bearing	LSR/FKM	LSR/FKM	LSR/FKM	LSR/FKM
8a	Washer for stop ring	Carbon/graphite HY22 in PTFE mass			
9	Chamber	Stainless steel	1.4301	1.4401	1.4539
13	Impeller	Stainless steel	1.4301	1.4401	1.4539
14	Suction interconnector	Cast stainless steel	1.4308	1.4408	1.4517
15	Strainer	Stainless steel	1.4301	1.4401	1.4539
16	Shaft complete	Stainless steel	1.4057	1.4460	1.4462
17	Strap	Stainless steel	1.4301	1.4401	1.4539
18	Cable guard	Stainless steel	1.4301	1.4401	1.4539

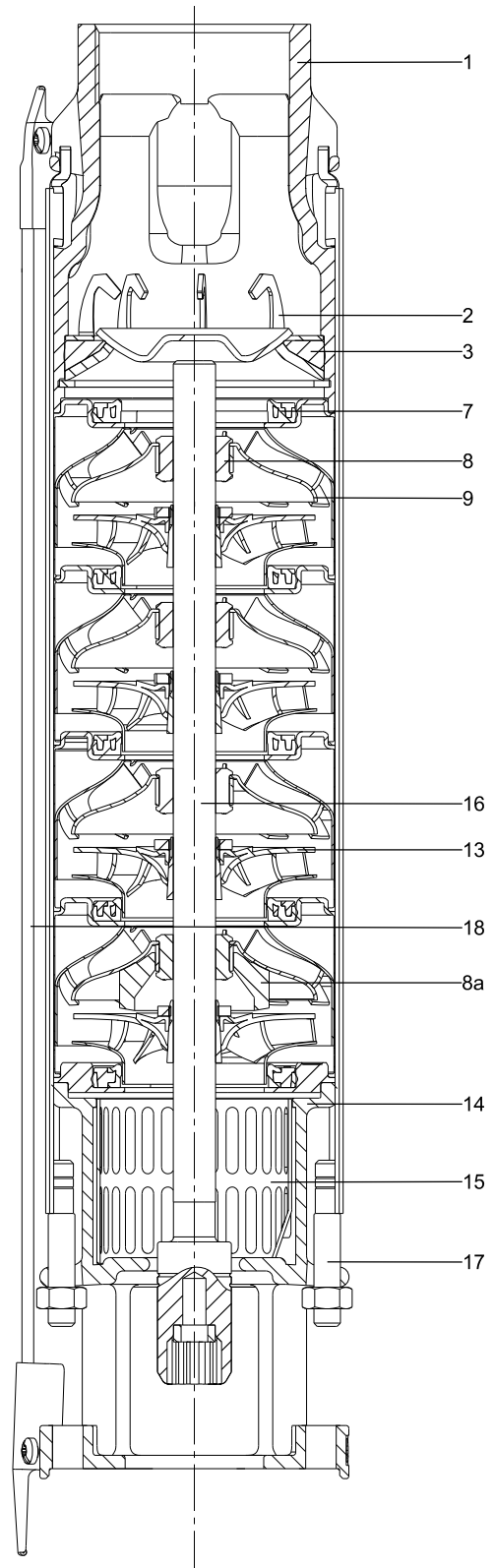

Fig. 9 Example SP 9

TM06 1110 1614

Material specification (SP 17 - SP 60)

Pos.	Component	Material	Standard	N-version	R-version
			EN		
1	Valve casing	Stainless steel	1.4301	1.4401	1.4539
2	Valve cup	Stainless steel	1.4301	1.4401	1.4539
	Valve seat	NBR-FKM	NBR-FKM	NBR-FKM	NBR-FKM
7	Neck ring	NBR-FKM	NBR-FKM	NBR-FKM	NBR-FKM
8	Bearing	NBR-FKM-LSR	NBR-FKM-LSR	NBR-FKM-LSR	NBR-FKM-LSR
8a	Washer for stop ring	Carbon/graphite HY22 in PTFE mass			
9	Chamber	Stainless steel	1.4301	1.4401	1.4539
13	Impeller	Stainless steel	1.4301	1.4401	1.4539
14	Suction interconnector	Cast stainless steel	1.4308	1.4408	1.4517
	Strainer	Stainless steel	1.4301	1.4401	1.4539
16	Shaft complete	Stainless steel	1.4057	1.4460	1.4462
17	Strap	Stainless steel	1.4301	1.4401	1.4539
18	Cable guard	Stainless steel	1.4301	1.4401	1.4539

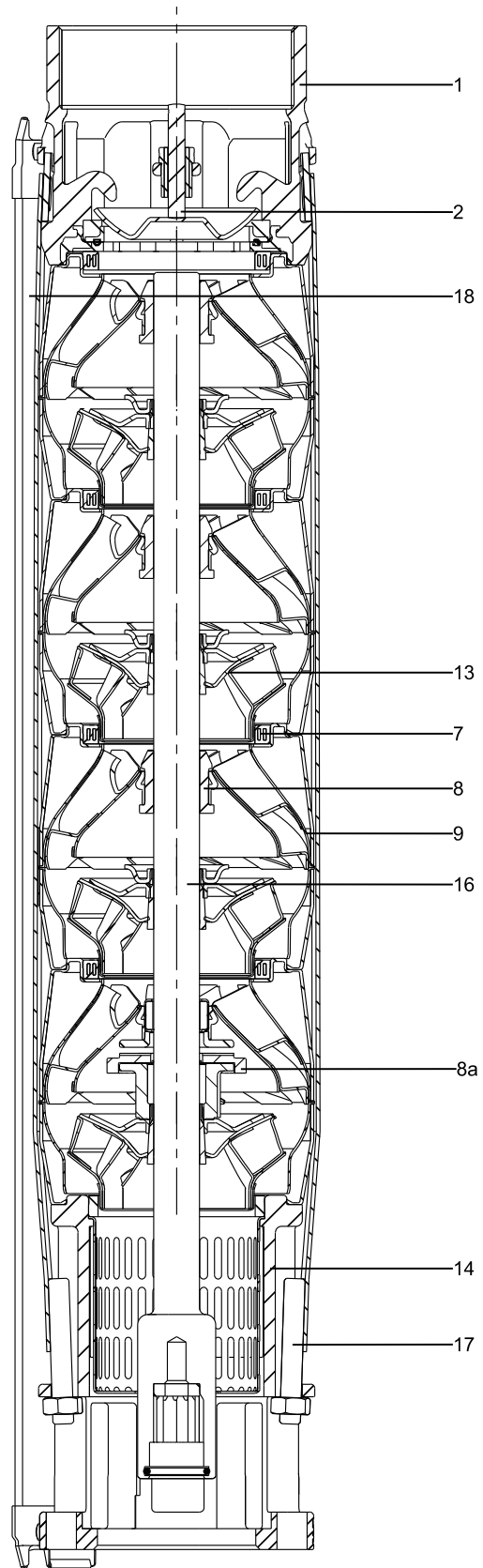

Fig. 10 Example SP 46

TM06 1521 1614

Material specification (SP 77 - SP 215)

Pos.	Component	Material	Standard	N-version	R-version
			EN		
1	Valve casing	Stainless steel	1.4301	1.4401	1.4539
2	Valve cup	Stainless steel	1.4301	1.4401	1.4539
	Valve seat	NBR-FKM	NBR-FKM	NBR-FKM	NBR-FKM
7	Neck ring	NBR-FKM	NBR-FKM	NBR-FKM	NBR-FKM
8	Bearing	NBR-FKM	NBR-FKM	NBR-FKM	NBR-FKM
	Washer for stop ring	Carbon/graphite HY22 in PTFE mass			
9	Chamber	Stainless steel	1.4301	1.4401	1.4539
13	Impeller	Stainless steel	1.4301	1.4401	1.4539
14	Suction interconnector	Cast stainless steel	1.4308	1.4408	1.4517
	Strainer	Stainless steel	1.4301	1.4401	1.4539
16	Shaft complete	Stainless steel	1.4057	1.4460	1.4462
17	Strap	Stainless steel	1.4301	1.4401	1.4539
18	Cable guard	Stainless steel	1.4301	1.4401	1.4539

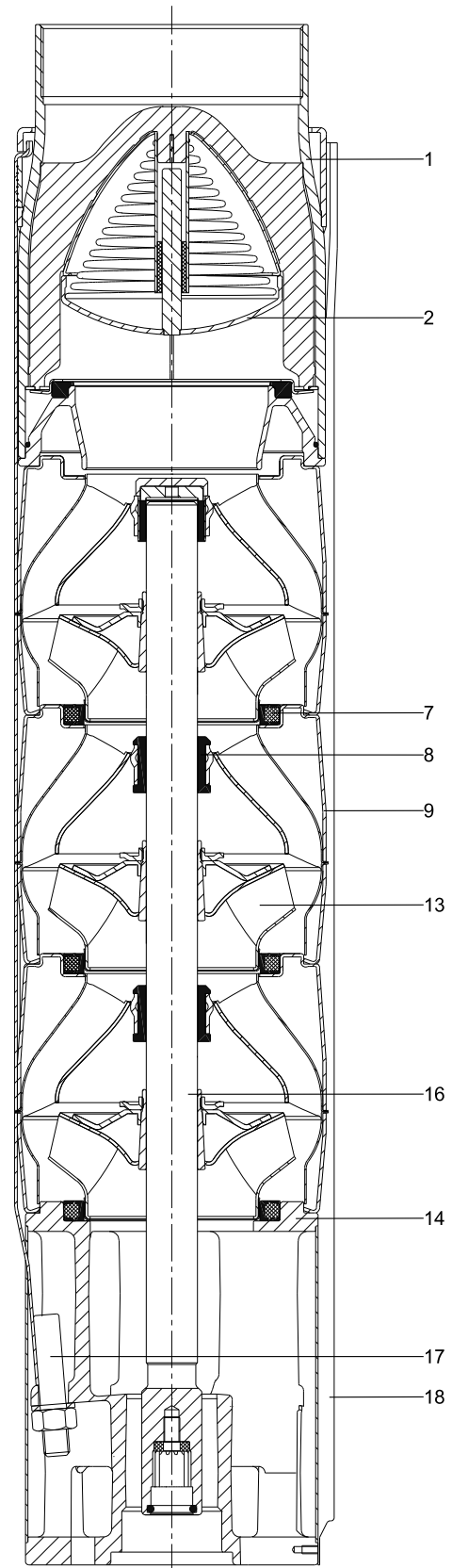

Fig. 11 Example SP 77

TM06 1192 1614

3. Submersible motors

For further information about Grundfos submersible motors, see the MS and MMS motor literature available on <https://product-selection.grundfos.com> (Grundfos Product Center).

Features and benefits

A complete motor range

Grundfos offers a complete range of submersible motors in different voltages:

Submersible motors, MS

- 4" motors, single-phase up to 2.2 kW:
 - 2-wire
 - 3-wire
 - PSC (permanent split capacitor)
- 4" motors, three-phase up to 7.5 kW
- 4" T60 motors, three-phase up to 5.5 kW
- 6" motors, three-phase from 5.5 to 30 kW
- 6" T60 motors, three-phase up to 22 kW.

Submersible, rewindable motors, MMS

- 6" motors, three-phase from 3.7 to 37 kW
- 8" motors, three-phase from 22 to 110 kW
- 10" motors, three-phase from 75 to 190 kW
- 12" motors, three-phase from 147 to 250 kW.

High motor efficiency

Within the area of high motor efficiency, Grundfos is a market leader.

Rewindable motors

The 2-pole Grundfos MMS submersible motors are all easy to rewind. The windings of the stator are made of a special waterproof wire of pure electrolytic copper sheathed with special non-hydroscopic thermoplastic material. The fine dielectric properties of this material allow direct contact between the windings and the liquid for efficient cooling of the windings.

Industrial motors (T60)

For heavy-duty applications, Grundfos offers a complete motor range of T60 motors with up to 5 % higher efficiency than that of Grundfos' standard motors. The T60 motors are available in sizes 2.2 to 22 kW. The cooling of the motor is very efficient due to the large motor surface. The efficient cooling makes it possible to increase the liquid temperature to 60 °C at a minimum flow of 1 m/s past the motor. The T60 motors are for customers who value low operating costs and long life higher than price.

Grundfos T60 motors are developed for difficult operating conditions. These motors will stand a higher thermal load than standard motors and thus have a longer life when subjected to high load. This applies whether the high load is caused by bad power supply, hot water, bad cooling conditions, high pump load, etc. Please note that heavy-duty motors are longer than motors for standard conditions.



Fig. 12 MS motors

TM00 7305 1096



Fig. 13 MMS motors

TM01 7873 4799 - GrA4575 3908

Overtemperature protection

Protecting the motor against too high motor temperature is the simplest and cheapest way of avoiding that the motor life is reduced.

Accessories for protection against overtemperature are available for both Grundfos MS and MMS submersible motors. When the temperature becomes too high, the protection device will cut out, and thereby avoid damage to the pump and motor.

MS

The Grundfos MS submersible motors, except MS 402, are available with built-in Tempcon temperature sensor for protection against overtemperature. By means of this sensor connected to the MP 204 motor protector via the power line, you can read out and/or monitor the motor temperature. As an alternative, you can fit the MS motors size 6" and larger with Pt100 and Pt1000 sensors for temperature monitoring via a control unit.

MMS

The Grundfos MMS submersible motors are not available with built-in Tempcon temperature sensor. For these motors, we offer Pt100 and Pt1000 sensors for temperature monitoring. Together with a control unit, the sensor ensures that the maximum operating temperature is not exceeded.

Protection against upthrust

In case of a very low counter pressure in connection with startup, there is a risk that the entire chamber stack may rise. This is called upthrust. Upthrust may damage both pump and motor. Therefore, both Grundfos pumps and motors are protected against upthrust as standard, preventing upthrust from occurring in the critical startup phase. The protection consists of either a built-in stop ring or hydraulic balancing.

Built-in cooling chambers

In all Grundfos MS submersible motors, cooling chambers at the top and at the bottom of the motor and internal circulation of motor liquid ensure efficient cooling. See fig. 14. As long as the required flow velocity past the motor is maintained (see section [Operating conditions](#) on page 18), cooling of the motor will be efficient.

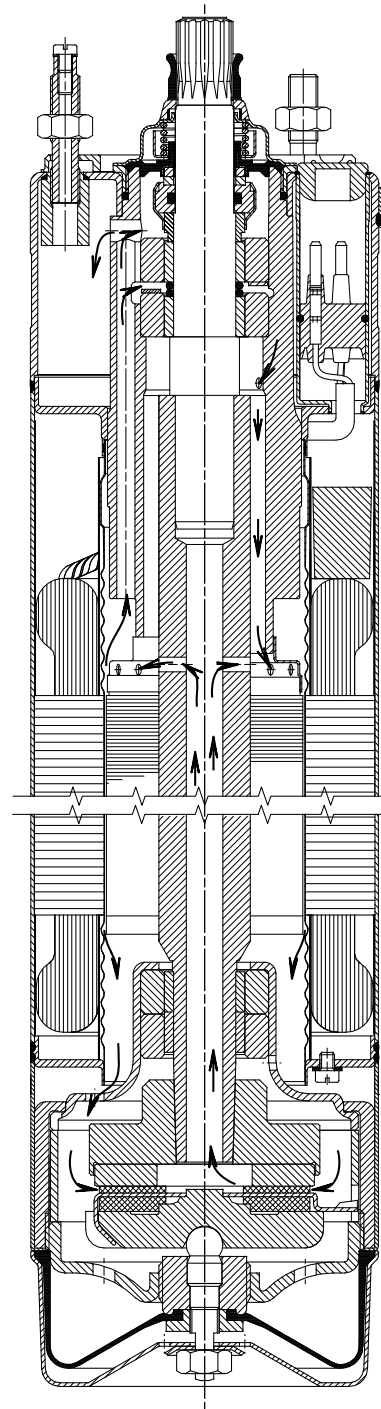

Fig. 14 MS 4000

TM00 5698 0996

Lightning protection

Grundfos recommends that you use extra lightning protection to minimise the risk of motor burnout caused by lightning strike.

Reduced risk of short-circuit

The stator is hermetically encapsulated in stainless steel. The stator windings are embedded in polymer compound. This results in high mechanical stability, optimum cooling and eliminates the risk of short circuits in the windings caused by condensing water.

Shaft seal

MS 402

The shaft seal is of the lip seal type characterised by low friction against the rotor shaft.

The choice of rubber offers good wear resistance, good elasticity and resistance to particles. The rubber material is approved for use in potable water.

MS 4000, MS 6000

The material is ceramic/tungsten carbide providing optimum sealing, optimum wear resistance and long life.

The spring-loaded shaft seal is designed with a large surface and a sand shield. The result is a minimum exchange of pumped liquid and motor liquid and no penetration of particles. Motors, version R, have a SiC/SiC shaft seal according to DIN 24960. Other combinations are available on request.

MMS rewindable motors

The standard shaft seal is a ceramic/carbon mechanical shaft seal. The shaft seal is replaceable.

The material provides good wear resistance and resistance to particles.

Together with the shaft seal housing, the sand shield forms a labyrinth seal, which during normal operating conditions prevents penetration of sand particles into the shaft seal.

On request, motors can be supplied with a SiC/SiC seal according to DIN 24960.

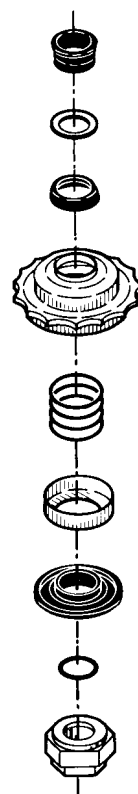

Fig. 15 Shaft seal, MS 4000

TM00 7306 2100

Material specification for MS motors

MS 402, MS 4000 and MS 6000 submersible motors

Pos.	Component	MS 402	MS 4000 MS 6000
1	Shaft	EN 1.4057	EN 1.4057
2	Shaft seal	NBR	Ceramic/tungsten carbide
3	Motor sleeve	EN 1.4301	EN 1.4301
4	Motor end shield		EN 1.4301
5	Radial bearing	Ceramic	Ceramic/tungsten carbide
6	Axial bearing	Ceramic/carbon	Ceramic/carbon
	Rubber parts	NBR	NBR

R-version motor

Pos.	Component	MS 4000 MS 6000
1	Shaft	EN 1.4462
2	Shaft seal	SiC/SiC
3	Motor sleeve	EN 1.4539
4	Motor end shield	EN 1.4539
5	Radial bearing	Ceramic/tungsten carbide
6	Thrust bearing	Ceramic/carbon
	Rubber parts	NBR

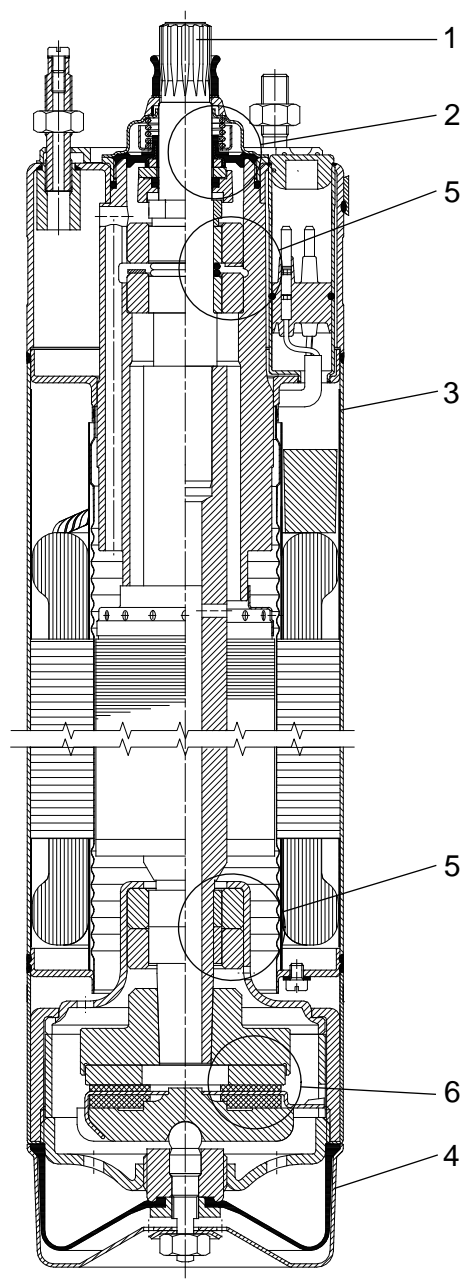

Fig. 16 MS 4000

TM00 7865 2196

Material specification for MMS motors

Submersible, rewindable motors

Pos.	Component	Material	EN
202	Shaft	Steel	1.0533
202a	Shaft ends	Stainless steel	1.4460
203/ 206	Thrust bearing Stationary/ rotating part	6" 5.5 - 37 kW	Hardened stainless steel/carbon
		8"-10"	Ceramic/ carbon
204	Bearing bush	6"-10"	Carbon
205	Bearing housing, upper	Cast iron	EN-JL1040
212	Diaphragm	CR/FKM	
213	Motor end shield	Cast iron	EN-JL1040
218	Motor sleeve	Stainless steel	1.4301
220	Motor cable	EPDM	
226	Shaft seal	Ceramic/ carbon or SiC/ SiC	
235	Intermediate housing	Cast iron	EN-JL1040
236	Bearing housing, lower	Cast iron	EN-JL1040

N- and R-versions of MMS motors

Pos.	Component	Material	Version	
			N	R
			EN	EN
202	Shaft	Steel	1.0533	1.0533
202a	Shaft ends	Stainless steel	1.4460	1.4462
203/ 206	Thrust bearing Stationary/ rotating part	6" 5.5 - 37 kW	Hardened stainless steel/ carbon	
			8"-10"	Ceramic/ carbon
204	Bearing bush	6"-10"	Carbon	
205	Bearing housing, upper	Stainless steel	1.4401	1.4539
212	Diaphragm	CR/FKM/ EPDM		
213	Motor end shield	Stainless steel	1.4401	1.4539
218	Motor sleeve	Stainless steel	1.4401	1.4539
220	Motor cable	EPDM		
226	Shaft seal	Ceramic/ carbon		
235	Intermediate housing	Stainless steel	1.4401	1.4539
236	Bearing housing, lower	Stainless steel	1.4401	1.4539

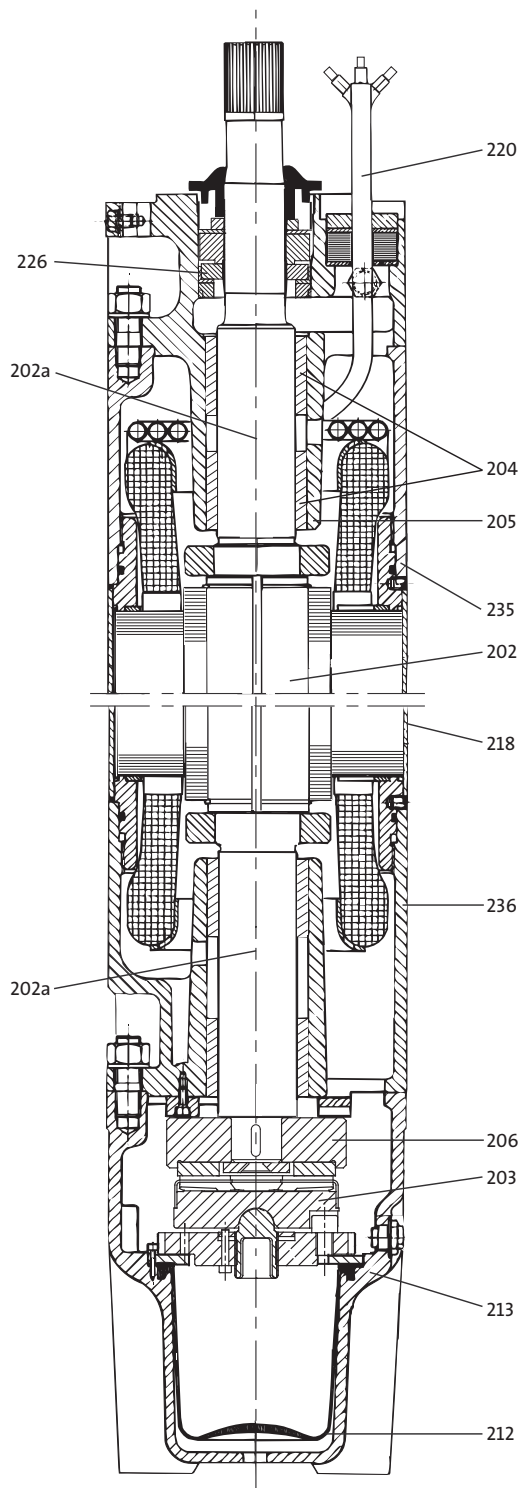

TM01 4985 0404

Fig. 17 MMS 10000

4. Operating conditions

To ensure long and trouble-free pump life, it is important that the following is observed.

Inlet pressure

The minimum inlet pressure is indicated by the NPSH-curves in the single-stage curve charts. The minimum safety margin of the NPSH-curves must always be 1.0 m head.

Minimum flow rate

To ensure sufficient cooling of the motor, the pump must not run continuously at a flow rate below 0.1 x nominal flow rate.

Operation of the pump against a closed valve must be limited to a maximum of 30 seconds due to the risk of local heating of the pumped liquid and the consequent damage to pump and motor.

Maximum flow rate

The pump must not run continuously at a flow rate above 1.3 x nominal flow rate due to the risk of upthrust and cavitation.

Pumped liquids

SP A and SP pumps are capable of pumping clean, thin, non-aggressive liquids, not containing solid particles or fibres larger than sand grains.

Pump type	Maximum content of sand [g/m ³]
SP 1-5	50
SP 7-14	150
SP 17-215	50*

* 6" pumps with LSR bearings can handle a maximum content of sand of 150 g/m³. Not standard.

A larger content of sand will reduce pump life.

The special SP A-N and SP-N versions made of stainless steel to EN 1.4401 and SP A-R and SP-R versions made of stainless steel to EN 1.4539 are available for applications involving aggressive liquids.

Special liquids

Pumping of liquids with a higher density than that of water requires a motor with a correspondingly higher output.

Pumping of liquids with a higher viscosity than that of water may result in

- increased pressure loss
- reduced hydraulic performance
- increased pump power input.

In case of doubt, contact Grundfos.

Liquid temperature

For protection of pump and motor rubber parts, the liquid temperature must not exceed 40 °C (~ 150 °F).

Operation at liquid temperatures between 40 and 60 °C (~ 150 and 140 °F) is possible, provided that you replace all rubber parts every three years.

Alternatively, you can fit the pump the pump with bearings made of FKM material, resistant to liquid temperatures of up to 90 °C.

Maximum liquid temperature

The maximum liquid temperature allowed depends on the flow velocity of the liquid past the motor, see the table below.

Grundfos motor	Flow velocity past motor [m/s]	Max. liquid temperature [°C]
MS 4"	0.15	40
MS 4" T60	0.15	60
MS 6000	0.15	40
MS 6000 T60	1.00	60
MMS 6" with PVC windings	0.15	25
	0.50	30
MMS 6" with PE/PA windings	0.15	45
	0.50	50
MMS 8", 10", 12" rewindable with PVC windings	0.15	25
	0.50	30
MMS 8", 10", 12" rewindable with PE/PA windings	0.15	40
	0.50	45

Note: For MMS 6", 37 kW, MMS 8", 110 kW, and MMS 10", 170 kW, the maximum liquid temperature is 5 °C lower than the values stated in the table above. For MMS 10", 190 kW, the temperature is 10 °C lower.

Maximum operating pressure

Grundfos motor	Maximum operating pressure
MS 402	1.5 MPa (15 bar)
MS 4000 and 6"	6 MPa (60 bar)
MMS 6", 8", 10", 12" rewindable	

Maximum start/stop frequency

The SP pump is suitable for continuous as well as intermittent operation:

Motor type	Number of starts
MS 402	<ul style="list-style-type: none"> Minimum 1 per year is recommended. Maximum 100 per hour. Maximum 300 per day.
MS 4000	<ul style="list-style-type: none"> Minimum 1 per year is recommended. Maximum 100 per hour. Maximum 300 per day.
MS 6000	<ul style="list-style-type: none"> Minimum 1 per year is recommended. Maximum 30 per hour. Maximum 300 per day.
MMS 6	PVC windings <ul style="list-style-type: none"> Minimum 1 per year is recommended. Maximum 3 per hour. Maximum 40 per day.
	PE/PA windings <ul style="list-style-type: none"> Minimum 1 per year is recommended. Maximum 10 per hour. Maximum 70 per day.
MMS 8000	PVC windings <ul style="list-style-type: none"> Minimum 1 per year is recommended. Maximum 3 per hour. Maximum 30 per day.
	PE/PA windings <ul style="list-style-type: none"> Minimum 1 per year is recommended. Maximum 8 per hour. Maximum 60 per day.
MMS 10000	PVC windings <ul style="list-style-type: none"> Minimum 1 per year is recommended. Maximum 2 per hour. Maximum 20 per day.
	PE/PA windings <ul style="list-style-type: none"> Minimum 1 per year is recommended. Maximum 6 per hour. Maximum 50 per day.
MMS 12000	PVC windings <ul style="list-style-type: none"> Minimum 1 per year is recommended. Maximum 2 per hour. Maximum 15 per day.
	PE/PA windings <ul style="list-style-type: none"> Minimum 1 per year is recommended. Maximum 5 per hour. Maximum 40 per day.

Moment of inertia

Calculate the moment of inertia by use of one of the formulas below. Choose the formula from pump size 4", 6" or 8" and insert the number of stages.

$$4": (0.2 + n \times 4.1) \times 10^{-4} \text{ [kgm}^2\text{]}$$

$$6": (4.0 + n \times 4.1) \times 10^{-4} \text{ [kgm}^2\text{]}$$

$$8": (6.0 + n \times 4.1) \times 10^{-4} \text{ [kgm}^2\text{]}$$

n = number of stages.

Service

If you request Grundfos to service the pump, contact Grundfos with details about the pumped liquid, etc. before you return the pump for service. Otherwise Grundfos can refuse to accept the pump for service.

Possible costs of returning the pump are to be paid by the customer.

However, any application for service, no matter to whom it may be made, must include details about the pumped liquid if the pump has been used for liquids which are injurious to health or toxic.

Before you return a pump, clean it in the best possible way.

Recommended minimum borehole diameter

If you use a connecting piece in the installation, the recommended minimum borehole diameter is the largest diameter of either pump or connecting piece.

The following table shows the recommended minimum borehole diameter of SP pumps with standard connections.

Pumps size	Starting	Motor size	Minimum borehole diameter				
			Rp 1 1/4 - 2" [mm]	Rp 2 1/2 " [mm]	Rp 3" [mm]	Rp 4" [mm]	R 4" [mm]
< SP 17		4"	105				
		6"	145				
SP 17	DOL	Motor size (# = pump in sleeve)	Rp 2 1/2"	R3"	3"NPT		
		4"	140	-	140		
		6"	145	-	145		
	Y/D	6"#	190	190	190		
		6"	150	-	150		
		6"#	180	180	180		
SP 60	DOL	Motor size	Rp 3"	Rp 4"	3" NPT	4" NPT	
		4"	150	155	150	155	
		6"	155	155	155	155	
	Y/D	8"	200	200	200	200	
		6"	160	160	160	160	
		8"	200	200	200	200	
SP 77	DOL	Motor size	Rp 4"	Rp 5"	4" NPT	5" NPT	5" GRF
		6"	188	188	188	188	215
		8"	206	206	206	206	215
	Y/D	6"	196	196	196	196	215
		8"	200	200	200	215	215
		Motor size	Rp 5"	Rp 6"	5" NPT	6" NPT	6" GRF
SP 125	DOL	6"	215	215	215	215	230
		8"	225	225	225	225	240
		6"	215	225	225	225	235
	Y/D	8"	235	240	240	240	255
		Motor size	Rp 6"	6" NPT	6" GRF		
		6"	246	246	246		
SP 215	DOL	8"	246	246	246		
		10"	257	257	257		
		12"	300	300	300		
		6"	257	257	257		
	Y/D	8"	257	257	257		
		10"	268	268	268		
		12"	300	300	300		
		Motor size	Rp 6"	6" NPT	6" GRF		

5. SP NE, SP A NE environmental pumps

Pump

Multistage, centrifugal pump with radial impellers directly coupled to a Grundfos submersible motor. The pump is made of stainless steel and has water-lubricated, FKM-rubber bearings.

Pump type	Pump stages	Pipe connection
SP 3A NE	6-29	Rp 1 1/4
SP 5A NE	4-33	Rp 1 1/2
SP 9 NE	4-21	Rp 2
SP 17 NE	1-10	Rp 2 1/2

Motor

The motor is suitable for aggressive and slightly contaminated or polluted liquids, including liquids containing oils.

The 2-pole, asynchronous, squirrel-cage MS 4000 RE motor of the canned type with journal bearings is made entirely of stainless steel. Electric tolerances comply with VDE 0530.

The type designation for RE is:

- R
Materials in stainless steel DIN W.-Nr. 1.4539.
- E
FKM rubber parts and shaft seal with ceramic tungsten-carbide shaft seals for optimum wear resistance.

Insulation class: F.

Enclosure class: IP58.

The motor cable is enclosed in PTFE and is one long cable without joints for increased cable life. Pumped liquids

Thin, non-explosive liquids without abrasive particles or fibres.

Maximum sand content: 50 g/m³.

Note: As the SP environmental pump has not been approved as explosion-proof, consult local authorities and regulations if you are in doubt whether to use the SP environmental pump for a specific application.

Order data

Product numbers

The pump is supplied complete with motor and cable guards fitted but without the cable with plug, which must be ordered separately.

SP A 3 NE, 3 x 400 V

Pump type	Motor		Product number
	Type	P ₂ [kW]	
SP 3A-6 NE	MS 4000 RE	0.75	10221906
SP 3A-9 NE			10221909
SP 3A-12 NE			10221912
SP 3A-15 NE			10221915
SP 3A-18 NE	MS 4000 RE	1.1	10221918
SP 3A-22 NE			10221922
SP 3A-25 NE			10221925
SP 3A-29 NE		2.2	10221929

SP A 5 NE, 3 x 400 V

Pump type	Motor		Product number
	Type	P ₂ [kW]	
SP 5A-4 NE	MS 4000 RE	0.75	05221904
SP 5A-6 NE			05221906
SP 5A-8 NE			05221908
SP 5A-12 NE			05221912
SP 5A-17 NE	MS 4000 RE	1.5	05221917
SP 5A-21 NE			05221921
SP 5A-25 NE			05221925
SP 5A-33 NE		3.0	05221933

SP 9 NE, 3 x 400 V

Pump type	Motor		Product number
	Type	P ₂ [kW]	
SP 9-4 NE	MS 4000 RE	0.75	98780186
SP 9-5 NE			98699015
SP 9-8 NE			98699016
SP 9-10 NE			98779885
SP 9-11 NE	MS 4000 RE	2.2	98699017
SP 9-13 NE			98699018
SP 9-16 NE			98699019
SP 9-16NE		4.0	98699020
SP 9-21 NE			98699021

SP 17 NE, 3 x 400 V

Pump type	Motor		Product number
	Type	P ₂ [kW]	
SP 17-1 NE	MS 4000 RE	0.75	12C91901
SP 17-2 NE		1.1	12C91902
SP 17-3 NE		2.2	12C91903
SP 17-4 NE			12C91904
SP 17-5 NE		3.0	12C91905
SP 17-6 NE		4.0	12C91906
SP 17-7 NE			12C91907
SP 17-8 NE			12C91908
SP 17-9 NE		5.5	12C91909
SP 17-10 NE			12C91910

Material specification SP NE, SPA NE pumps

Pos.	Component	Material	DIN W.-Nr.
1	Valve casing	Stainless steel	1.4401
2	Top bearing	FKM	
3	Chamber	Stainless steel	1.4401
4	Intermediate bearing	FKM	
5	Impeller	Stainless steel	1.4401
6	Suction interconnector	Stainless steel	1.4401
7	Shaft	Stainless steel	1.4401
8	Strap	Stainless steel	1.4401

Material specification (motor)

Pos.	Component	Material	DIN W.-Nr.
9	Radial bearing	Ceramics/tungsten carbide	
10	Thrust bearings	Carbon/ceramics	
11	Shaft end	Stainless steel	1.4462
12	Stator housing	Stainless steel	1.4539
13	End shield	Stainless steel	1.4539
	O-rings	FKM	

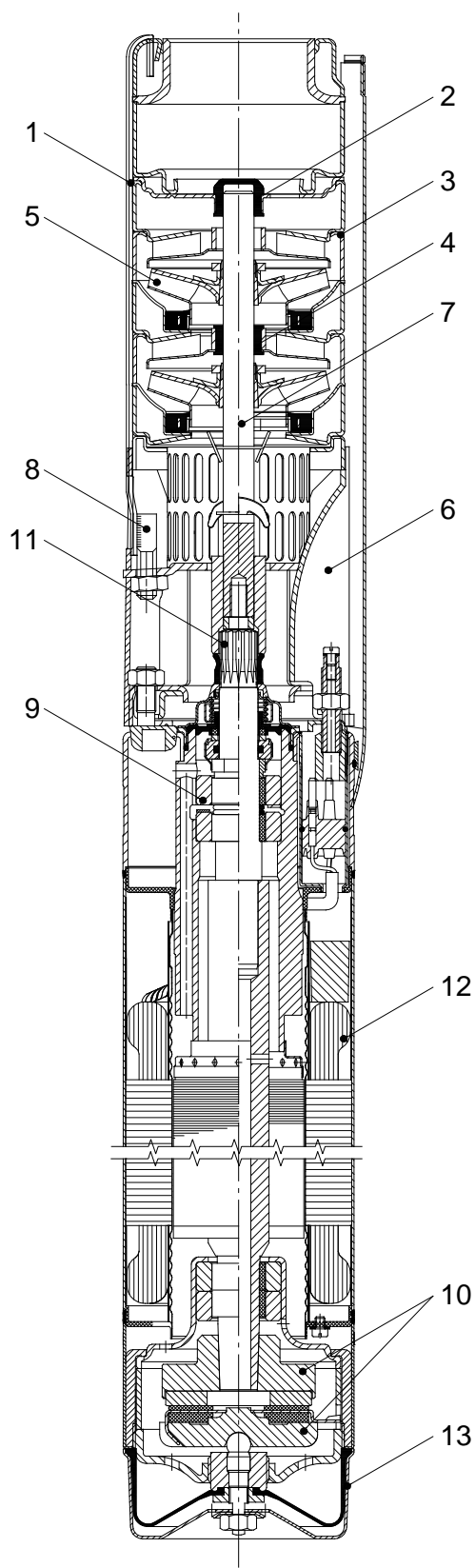
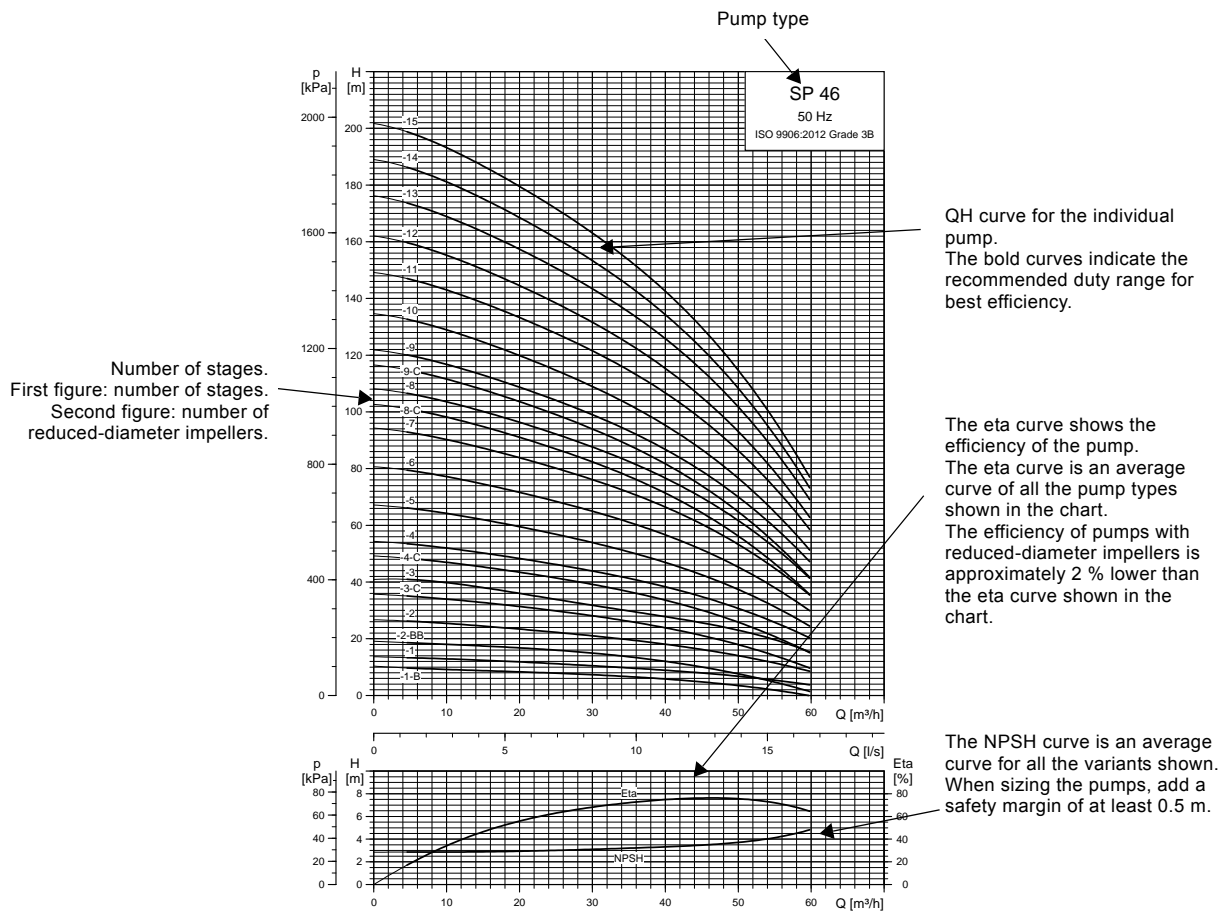

Fig. 18 SP 5A NE

TM01 9176 1500

How to read the curve charts



TM01 8765 2414

Fig. 19 How to read the curve charts

Curve conditions

The conditions below apply to the curves on pages 24 to 88.

General conditions

- Curve tolerances according to ISO 9906:2012 - Grade 3B.
- The performance curves show pump performance at actual speed, cf. standard motor range.
Approximate motor speeds:
4" motors: $n = 2870 \text{ min}^{-1}$
6" motors: $n = 2870 \text{ min}^{-1}$
8" to 12" motors: $n = 2900 \text{ min}^{-1}$.
- The measurements were made with airless water at a temperature of 20 °C. The curves apply to a kinematic viscosity of 1 mm²/s (1 cSt). When pumping liquids with a density higher than that of water, use motors with correspondingly higher outputs.
- The bold curves indicate the recommended performance range.
- The performance curves are inclusive of possible losses such as non-return valve loss.

SP A, SP curves

- **Q/H:** The curves are inclusive of valve and inlet losses at the actual speed.
Operation without non-return valve will increase the actual head at rated performance by 0.5 to 1.0 m.
- **NPSH:** The curve is inclusive of pressure loss in the suction interconnector and shows the required inlet pressure.
- **Power curve:** P2 shows the pump power input of each stage for the individual pump size when the pump is running at the rated speed.
- **Efficiency curve:** Eta shows pump stage efficiency. If Eta for the actual pump size is needed, please consult <https://product-selection.grundfos.com> (Grundfos Product Center).

6. Performance curves and technical data

SP 1A

Performance curves

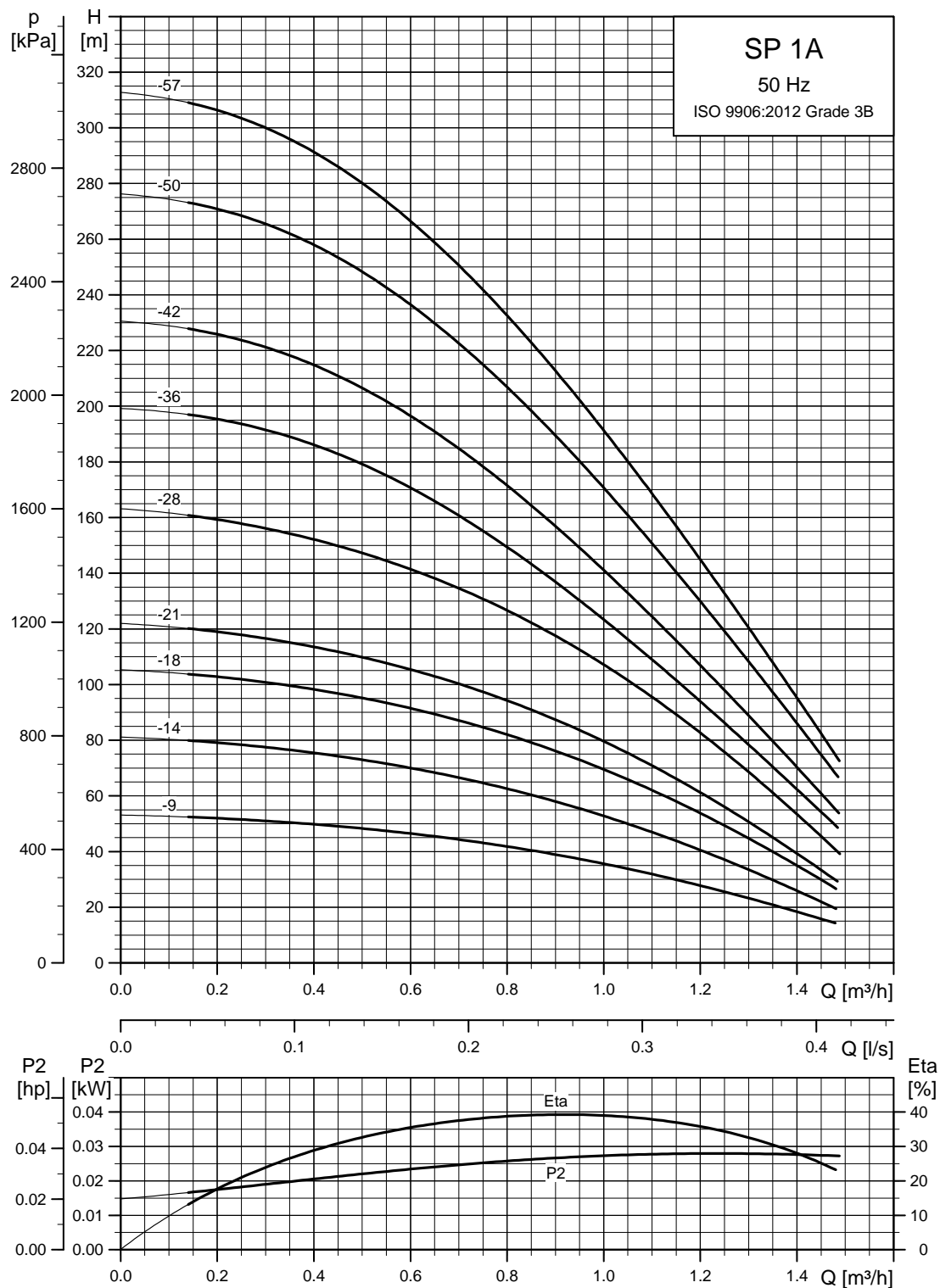

See also section [How to read the curve charts](#) on page 23.

TM00 7271 4702

Dimensions and weights

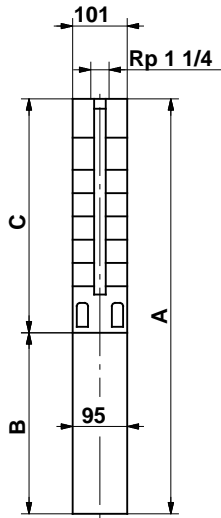

101 mm = Maximum diameter of pump inclusive of cable guard and motor.

TM00 0955 1196

Pump type	Motor		Dimensions [mm]			Net weight [kg]
	Type	Power [kW]	C	B	A	
Single-phase, 1 x 230 V						
SP 1A-9	MS 402	0.37	344	256	600	11
SP 1A-14	MS 402	0.37	449	256	705	12
SP 1A-18	MS 402	0.55	533	291	824	14
SP 1A-21	MS 402	0.55	596	291	887	14
SP 1A-28	MS 402	0.75	743	306	1049	16
SP 1A-36	MS 402	1.1	956	346	1302	25
SP 1A-42	MS 402	1.1	1082	346	1428	27
SP 1A-50	MS 402	1.5	1250	346	1596	30
SP 1A-57	MS 402	1.5	1397	346	1743	32
Three-phase, 3 x 230 V / 3 x 400 V						
SP 1A-9	MS 402	0.37	344	226	570	9
SP 1A-14	MS 402	0.37	449	226	675	10
SP 1A-18	MS 402	0.55	533	241	774	12
SP 1A-21	MS 402	0.55	596	241	837	12
SP 1A-28	MS 402	0.75	743	276	1019	15
SP 1A-36	MS 402	1.1	956	306	1262	23
SP 1A-42	MS 402	1.1	1082	306	1388	25
SP 1A-50	MS 402	1.5	1250	346	1596	29
SP 1A-57	MS 402	1.5	1397	346	1743	32

SP 2A

Performance curves

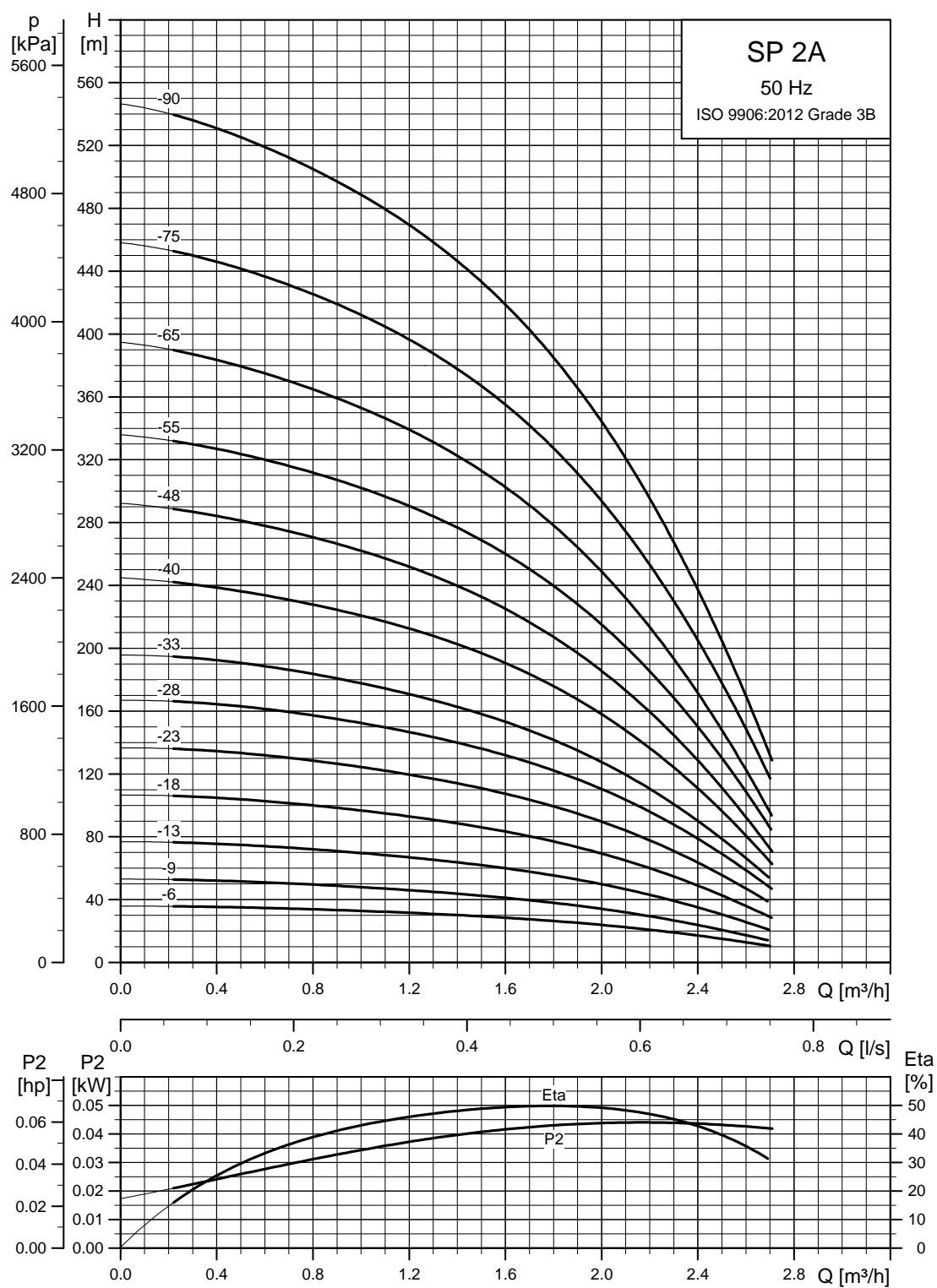

See also section [How to read the curve charts](#) on page 23.

TM00 7272 4702

Dimensions and weights

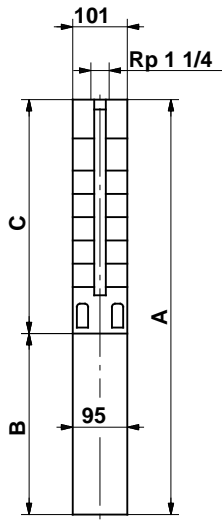

101 mm = Maximum diameter of pump inclusive of cable guard and motor.

SP 2A-75 and SP 2A-90 are mounted in sleeve for R 1 1/4 connection and with a maximum diameter of 108 mm.

TM00 0955 1196

Pump type	Motor		Dimensions [mm]			Net weight [kg]
	Type	Power [kW]	C	B	A	
Single-phase, 1 x 230 V						
SP 2A-6	MS 402	0.37	281	256	537	10
SP 2A-9	MS 402	0.37	344	256	600	11
SP 2A-13	MS 402	0.55	428	291	719	13
SP 2A-18	MS 402	0.75	533	306	839	15
SP 2A-23	MS 402	1.1	638	346	984	17
SP 2A-28	MS 402	1.5	743	346	1089	19
SP 2A-33	MS 402	1.5	844	346	1190	20
SP 2A-40	MS 4000	2.2	1040	573	1613	37
SP 2A-48	MS 4000	2.2	1208	573	1781	39
Three-phase, 3 x 230 V / 3 x 400 V						
SP 2A-6	MS 402	0.37	281	226	507	9
SP 2A-9	MS 402	0.37	344	226	570	9
SP 2A-13	MS 402	0.55	428	241	669	11
SP 2A-18	MS 402	0.75	533	276	809	13
SP 2A-23	MS 402	1.1	638	306	944	16
SP 2A-28	MS 402	1.5	743	346	1089	18
SP 2A-33	MS 402	1.5	844	346	1190	19
SP 2A-40	MS 402	2.2	1040	346	1386	27
SP 2A-48	MS 402	2.2	1208	346	1554	30
SP 2A-55	MS 4000	3.0	1355	493	1848	38
SP 2A-65	MS 4000	3.0	1565	493	2058	41
SP 2A-75	MS 4000	4.0	1954	573	2527	57
SP 2A-90	MS 4000	4.0	2269	573	2842	64

SP 3A

Performance curves

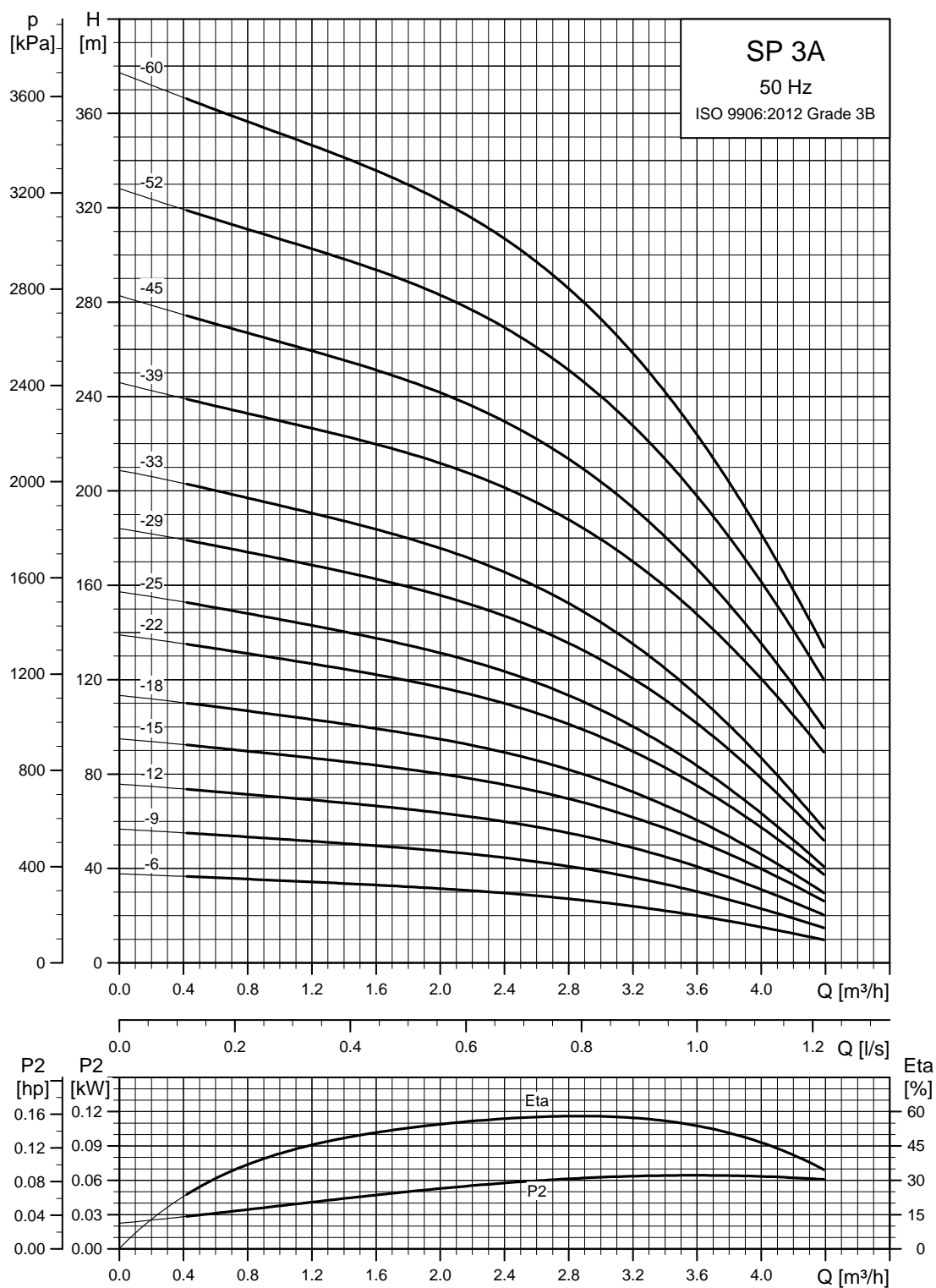

See also section [How to read the curve charts](#) on page 23.

TM00 7273 4702

Dimensions and weights

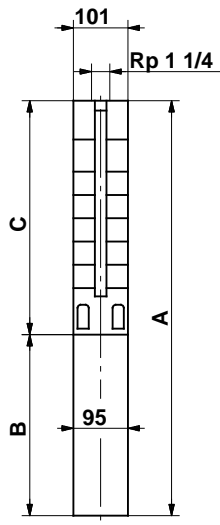

101 mm = Maximum diameter of pump inclusive of cable guard and motor.

TM00 0955 1196

Pump type	Motor		Dimensions [mm]			Net weight [kg]
	Type	Power [kW]	C	B	A	
Single-phase, 1 x 230 V						
SP 3A-6*	MS 402	0.37	281	256	537	10
SP 3A-6N	MS 4000R	2.2	326	573	899	26
SP 3A-9*	MS 402	0.55	344	291	635	12
SP 3A-9N	MS 4000R	2.2	389	573	962	27
SP 3A-12*	MS 402	0.75	407	306	713	13
SP 3A-12N	MS 4000R	2.2	452	573	1025	28
SP 3A-15*	MS 402	1.1	470	346	816	16
SP 3A-15N	MS 4000R	2.2	515	573	1088	29
SP 3A-18*	MS 402	1.1	533	346	879	16
SP 3A-18N	MS 4000R	2.2	578	573	1151	30
SP 3A-22*	MS 402	1.5	617	346	963	18
SP 3A-22N	MS 4000R	2.2	662	573	1235	31
SP 3A-25*	MS 402	1.5	680	346	1026	18
SP 3A-25N	MS 4000R	2.2	725	573	1298	32
SP 3A-29*	MS 4000	2.2	764	573	1337	29
SP 3A-29N	MS 4000R	2.2	809	573	1382	33
SP 3A-33*	MS 4000	2.2	848	573	1421	30
SP 3A-33N	MS 4000R	2.2	893	573	1466	34
Three-phase, 3 x 230 V / 3 x 400 V						
SP 3A-6*	MS 402	0.37	281	226	507	9
SP 3A-6N	MS 4000R	0.75	326	398	724	18
SP 3A-9*	MS 402	0.55	344	241	585	10
SP 3A-9N	MS 4000R	0.75	389	398	787	19
SP 3A-12*	MS 402	0.75	407	276	683	12
SP 3A-12N	MS 4000R	0.75	452	398	850	20
SP 3A-15*	MS 402	1.1	470	306	776	14
SP 3A-15N	MS 4000R	1.1	515	413	928	22
SP 3A-18*	MS 402	1.1	533	306	839	15
SP 3A-18N	MS 4000R	1.1	578	413	991	23
SP 3A-22*	MS 402	1.5	617	346	963	17
SP 3A-22N	MS 4000R	1.5	662	413	1075	24
SP 3A-25*	MS 402	1.5	680	346	1026	18
SP 3A-25N	MS 4000R	1.5	725	413	1138	25
SP 3A-29*	MS 402	2.2	764	346	1110	20
SP 3A-29N	MS 4000R	2.2	809	453	1262	28
SP 3A-33*	MS 402	2.2	848	346	1194	21
SP 3A-33N	MS 4000R	2.2	893	453	1346	29
SP 3A-39	MS 4000	3.0	1019	493	1512	32
SP 3A-45	MS 4000	3.0	1145	493	1638	34
SP 3A-52	MS 4000	4.0	1292	573	1865	41
SP 3A-60	MS 4000	4.0	1460	573	2033	43

* Pumps with spline shaft are only available in stainless steel EN 1.4301/ 304.

Note: All other pumps listed above are also available in N- and R-versions. See page 6.

SP 5A

Performance curves

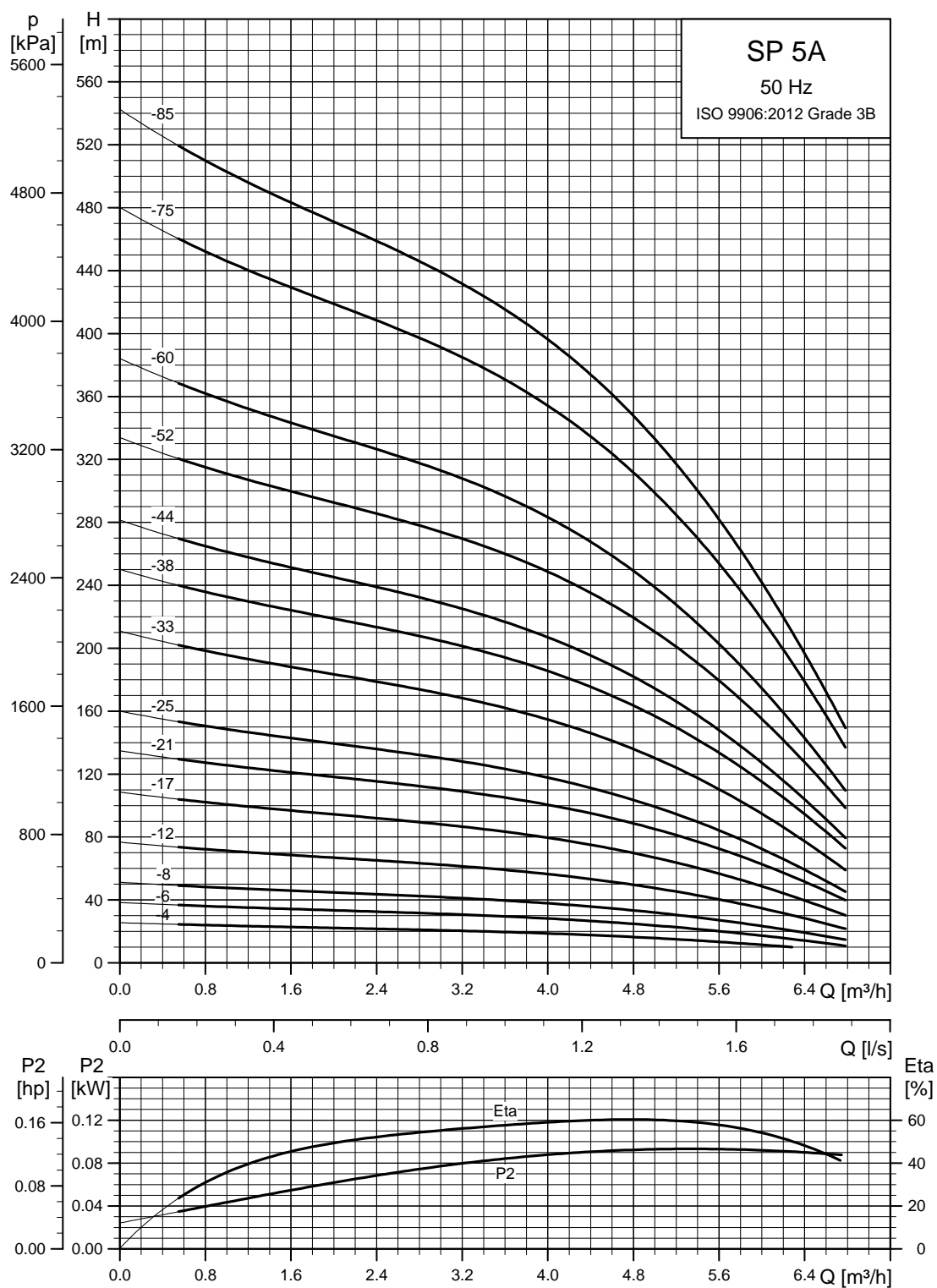

See also section [How to read the curve charts](#) on page 23.

TM00 7274 4702

Dimensions and weights

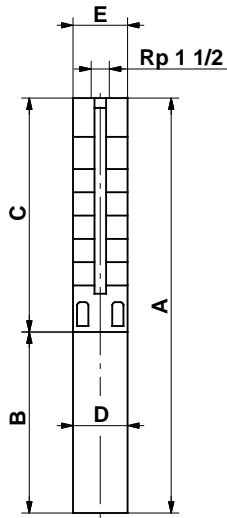

TM00 0956 1196

SP 5A-75 and SP 5A-85 are mounted in sleeve for R 1 1/2 connection.

Pump type	Motor		Dimensions [mm]					Net weight [kg]
	Type	Power [kW]	C	B	A	D	E	
Single-phase, 1 x 230 V								
SP 5A-4*	MS 402	0.37	240	256	496	95	101	10
SP 5A-4N	MS 4000R	2.2	284	573	857	95	101	25
SP 5A-6*	MS 402	0.55	282	291	573	95	101	11
SP 5A-6N	MS 4000R	2.2	326	573	899	95	101	26
SP 5A-8*	MS 402	0.75	324	306	630	95	101	13
SP 5A-8N	MS 4000R	2.2	368	573	941	95	101	27
SP 5A-12*	MS 402	1.1	408	346	754	95	101	15
SP 5A-12N	MS 4000R	2.2	452	573	1025	95	101	28
SP 5A-17*	MS 402	1.5	513	346	859	95	101	17
SP 5A-17N	MS 4000R	2.2	557	573	1130	95	101	29
SP 5A-21*	MS 4000	2.2	597	573	1170	95	101	27
SP 5A-21N	MS 4000R	2.2	641	573	1214	95	101	30
SP 5A-25*	MS 4000	2.2	681	573	1254	95	101	28
SP 5A-25N	MS 4000R	2.2	725	573	1298	95	101	32
Three-phase, 3 x 230 V / 3 x 400 V								
SP 5A-4*	MS 402	0.37	240	226	466	95	101	8
SP 5A-4N	MS 4000R	0.75	284	398	682	95	101	17
SP 5A-6*	MS 402	0.55	282	241	523	95	101	10
SP 5A-6N	MS 4000R	0.75	326	398	724	95	101	18
SP 5A-8*	MS 402	0.75	324	276	600	95	101	11
SP 5A-8N	MS 4000R	0.75	368	398	766	95	101	19
SP 5A-12*	MS 402	1.1	408	306	714	95	101	13
SP 5A-12N	MS 4000R	1.1	452	413	865	95	101	21
SP 5A-17*	MS 402	1.5	513	346	859	95	101	16
SP 5A-17N	MS 4000R	1.5	557	413	970	95	101	22
SP 5A-21*	MS 402	2.2	597	346	943	95	101	18
SP 5A-21N	MS 4000R	2.2	641	453	1094	95	101	25
SP 5A-25*	MS 402	2.2	681	346	1027	95	101	19
SP 5A-25N	MS 4000R	2.2	725	453	1178	95	101	27
SP 5A-33*	MS 4000	3.0	849	493	1342	95	101	26
SP 5A-33N	MS 4000R	3.0	893	493	1386	95	101	30
SP 5A-38	MS 4000	4.0	998	573	1571	95	101	36
SP 5A-44	MS 4000	4.0	1124	573	1697	95	101	38
SP 5A-52	MS 4000	5.5	1292	673	1965	95	101	46
SP 5A-60	MS 4000	5.5	1460	673	2133	95	101	48
SP 5A-52	MS 6000	5.5	1354	541	1895	139.5	139.5	60
SP 5A-60	MS 6000	5.5	1522	541	2063	139.5	139.5	63
SP 5A-75	MS 6000	7.5	2146	571	2717	139.5	140	86
SP 5A-85	MS 6000	7.5	2356	571	2927	139.5	140	92

E = Maximum diameter of pump inclusive of cable guard and motor.

* Pumps with spline shaft are only available in stainless steel EN 1.4301/ 304.

Note: All other pumps listed above are also available in N- and R-versions. See page 6. Pumps mounted in sleeve are only available in standard and N-versions.

SP 7

Performance curves

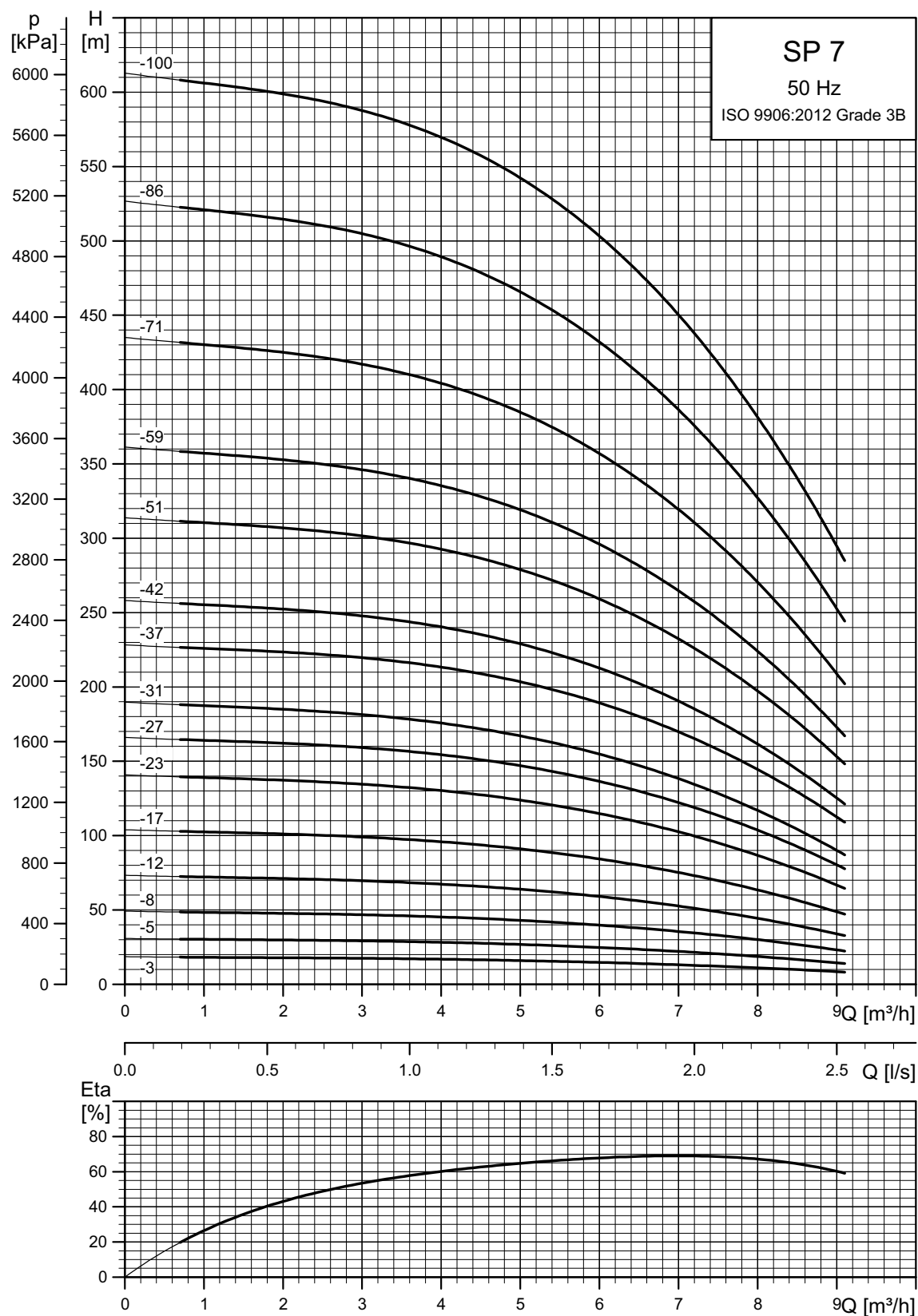

TM06 4316 19/15

See also section [How to read the curve charts](#) on page 23.

Dimensions and weights

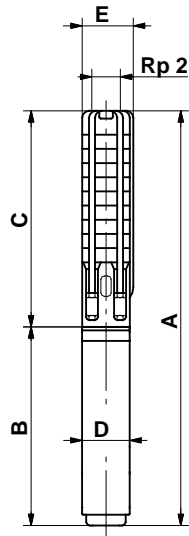

TM00 0957 1196

SP 7-71 to SP 7-100 are mounted in sleeve.

Pump type	Motor		Dimensions [mm]					Net weight [kg]
	Type	Power [kW]	C	B	A	D	E	
Single-phase, 1 x 230 V / 1 x 240 V								
SP 7-3	MS 402	0.55	388	317	705	95	101	14.0
SP 7-5	MS 402	0.75	488	347	835	95	101	16.4
SP 7-8	MS 402	1.1	638	387	1025	95	101	20.1
SP 7-12	MS 402	1.5	838	387	1225	95	101	22.3
SP 7-17	MS 4000	2.2	1088	577	1665	95	101	35.7
Three-phase, 3 x 220-230 V / 3 x 380-400-415 V								
SP 7-3	MS 402	0.55	388	282	670	95	101	12.5
SP 7-5	MS 402	0.75	488	317	805	95	101	15.2
SP 7-8	MS 402	1.1	638	347	985	95	101	18.3
SP 7-12	MS 402	1.5	838	387	1225	95	101	22.3
SP 7-17	MS 402	2.2	1088	387	1475	95	101	26.6
SP 7-5	MS 4000	0.75	488	402	890	95	101	19.7
SP 7-8	MS 4000	1.1	638	417	1055	95	101	22.5
SP 7-12	MS 4000	1.5	838	417	1255	95	101	24.8
SP 7-17	MS 4000	2.2	1088	457	1545	95	101	29.7
SP 7-23	MS 4000	3	1388	497	1885	95	101	35.1
SP 7-27	MS 4000	4	1588	577	2165	95	101	41.4
SP 7-31	MS 4000	4	1788	577	2365	95	101	43.7
SP 7-37	MS 4000	5.5	2088	677	2765	95	101	52.2
SP 7-42	MS 4000	5.5	2338	677	3015	95	101	55.1
SP 7-51	MS 4000	7.5	2788	777	3565	95	101	64.4
SP 7-59	MS 4000	7.5	3188	777	3965	95	101	69.1
SP 7-37	MS 6000	5.5	2151	547	2698	139.5	139.5	63.4
SP 7-42	MS 6000	5.5	2401	547	2948	139.5	139.5	66.3
SP 7-51	MS 6000	7.5	2851	577	3428	139.5	139.5	74.7
SP 7-59	MS 6000	7.5	3251	577	3828	139.5	139.5	79.4
SP 7-71	MS 6000	9.2	4146	607	4753	139.5	140	120.1
SP 7-86	MS 6000	11	4896	637	5533	139.5	140	136.1
SP 7-100	MS 6000	13	5596	667	6263	139.5	140	151.3

E = Maximum diameter of pump inclusive of cable guard and motor.

Note: The pump types above are also available in N- and R-versions. See page 6. Pumps mounted in sleeve are only available in standard and N-versions.

Power curves

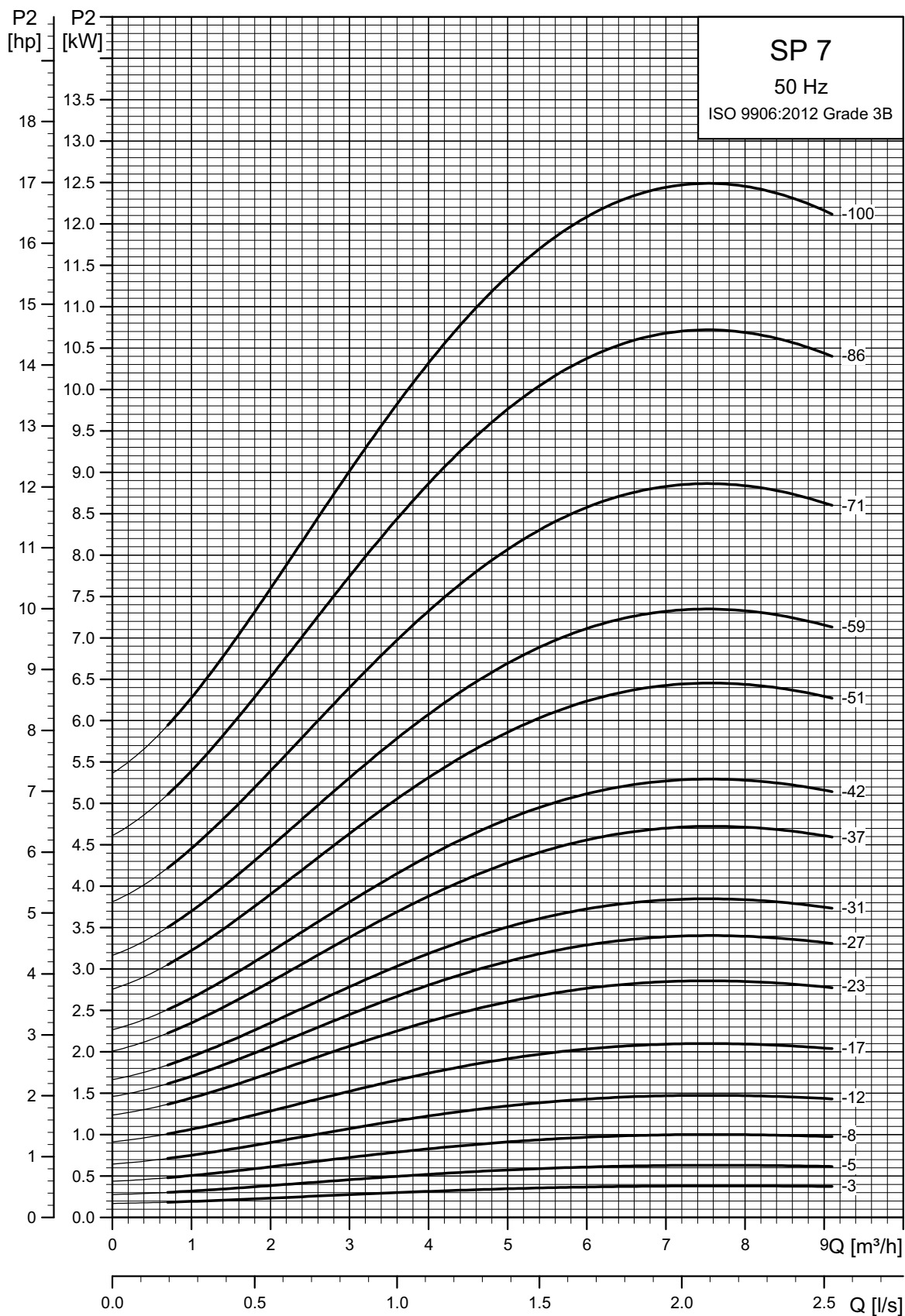

TM06 4317 1915

SP 9

Performance curves

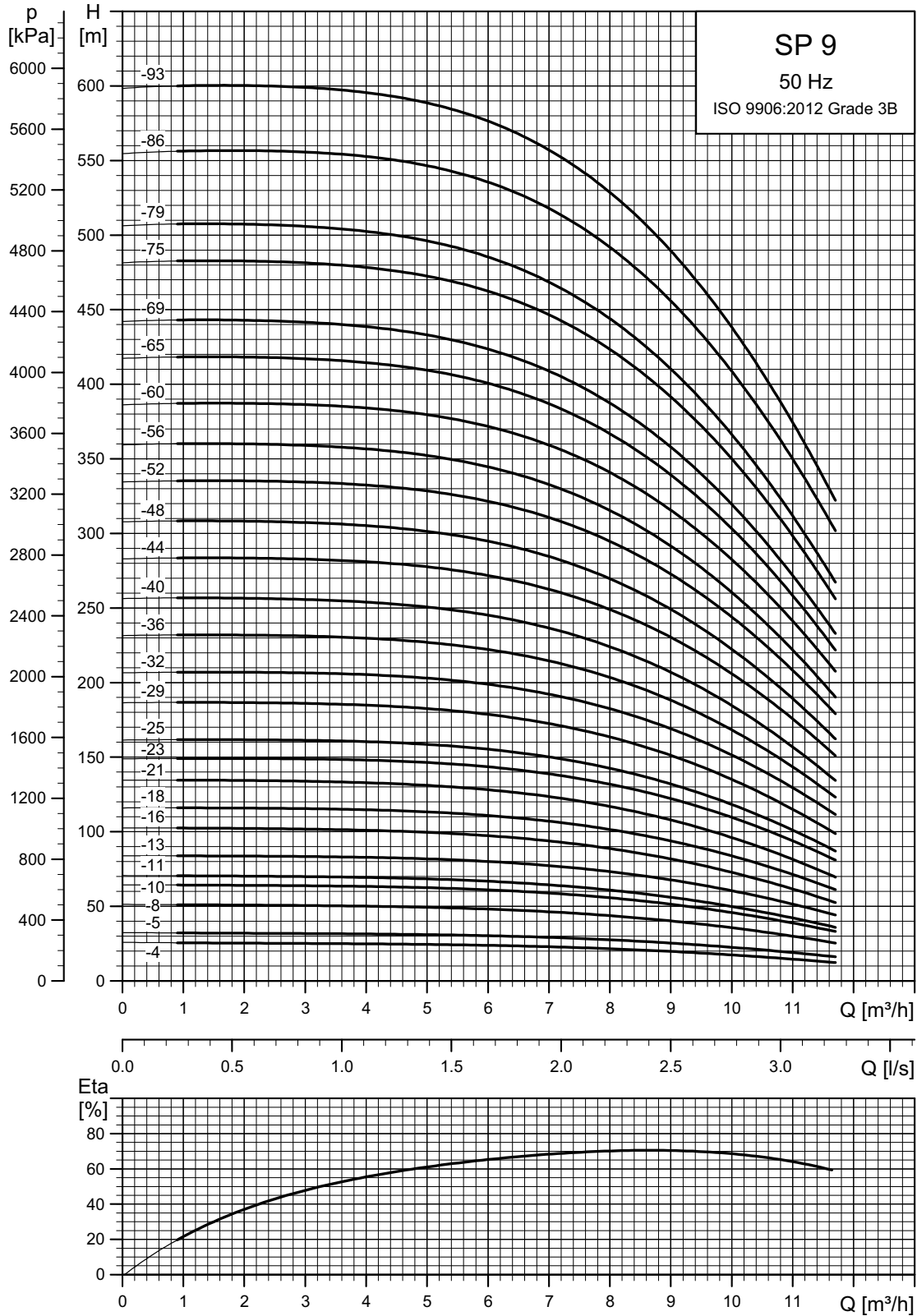

See also section [How to read the curve charts](#) on page 23.

TM06 1424 2414

Dimensions and weights

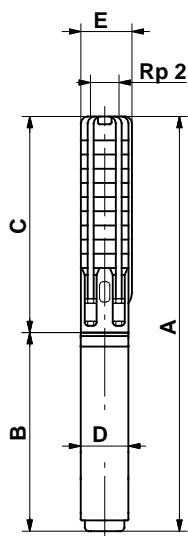

TM00 0957 1196

SP 9-56 to SP 9-86 are mounted in sleeve for R 2 connection.

Pump type	Motor		Dimensions [mm]					Net weight [kg]
	Type	Power [kW]	C	B	A	D	E	
Single-phase, 1 x 230 V / 1 x 240 V								
SP 9-4	MS 402	0.75	438	347	785	95	101	15.9
SP 9-5	MS 402	1.1	488	387	875	95	101	18.3
SP 9-8	MS 402	1.5	638	387	1025	95	101	20.0
SP 9-10	MS 4000	2.2	738	577	1315	95	101	31.6
SP 9-11	MS 4000	2.2	788	577	1365	95	101	32.2
Three-phase, 3 x 220-230 V / 3 x 380-400-415 V								
SP 9-4	MS 402	0.75	438	317	755	95	101	14.7
SP 9-5	MS 402	1.1	488	347	835	95	101	16.5
SP 9-8	MS 402	1.5	638	387	1025	95	101	20.0
SP 9-10	MS 402	2.2	738	387	1125	95	101	22.5
SP 9-11	MS 402	2.2	788	387	1175	95	101	23.1
SP 9-4	MS 4000	0.75	438	402	840	95	101	19.2
SP 9-5	MS 4000	1.1	488	417	905	95	101	20.7
SP 9-8	MS 4000	1.5	638	417	1055	95	101	22.5
SP 9-10	MS 4000	2.2	738	457	1195	95	101	25.6
SP 9-11	MS 4000	2.2	788	457	1245	95	101	26.2
SP 9-13	MS 4000	3	888	497	1385	95	101	29.3
SP 9-16	MS 4000	3	1038	497	1535	95	101	31.0
SP 9-18	MS 4000	4	1138	577	1715	95	101	36.2
SP 9-21	MS 4000	4	1288	577	1865	95	101	37.9
SP 9-23	MS 4000	5.5	1388	677	2065	95	101	44.1
SP 9-25	MS 4000	5.5	1488	677	2165	95	101	45.2
SP 9-29	MS 4000	5.5	1688	677	2365	95	101	47.7
SP 9-32	MS 4000	7.5	1838	777	2615	95	101	53.4
SP 9-36	MS 4000	7.5	2038	777	2815	95	101	55.7
SP 9-40	MS 4000	7.5	2238	777	3015	95	101	58.0
SP 9-23	MS 6000	5.5	1451	547	1998	139.5	139.5	55.0
SP 9-25	MS 6000	5.5	1551	547	2098	139.5	139.5	56.2
SP 9-29	MS 6000	5.5	1751	547	2298	139.5	139.5	58.6
SP 9-32	MS 6000	7.5	1901	577	2478	139.5	139.5	63.4
SP 9-36	MS 6000	7.5	2101	577	2678	139.5	139.5	65.8
SP 9-40	MS 6000	7.5	2301	577	2878	139.5	139.5	68.1
SP 9-44	MS 6000	9.2	2501	607	3108	139.5	139.5	78.2
SP 9-48	MS 6000	9.2	2701	607	3308	139.5	139.5	80.6
SP 9-52	MS 6000	11	2901	637	3538	139.5	139.5	86.1
SP 9-56	MS 6000	11	3396	637	4033	139.5	140	110.0
SP 9-60	MS 6000	13	3596	667	4263	139.5	140	116.5
SP 9-65	MS 6000	13	3846	667	4513	139.5	140	120.9
SP 9-69	MS 6000	13	4046	667	4713	139.5	140	124.3
SP 9-75	MS 6000	15	4346	702	5048	139.5	140	133.6
SP 9-79	MS 6000	15	4546	702	5248	139.5	140	137.1
SP 9-86	MS 6000	18.5	4896	757	5653	139.5	140	147.6
SP 9-93	MS 6000	18.5	5246	757	6003	139.5	140	153.7
SP 9-79	MS 6000	15	4546	702	5248	139.5	140	137.1
SP 9-86	MS 6000	18.5	4896	757	5653	139.5	140	147.6
SP 9-93	MS 6000	18.5	5246	757	6003	139.5	140	153.7

E = Maximum diameter of pump inclusive of cable guard and motor.

Note: The pump types above are also available in N- and R-versions. See page 6. Pumps mounted in sleeve are only available in standard and N-versions.

Power curves

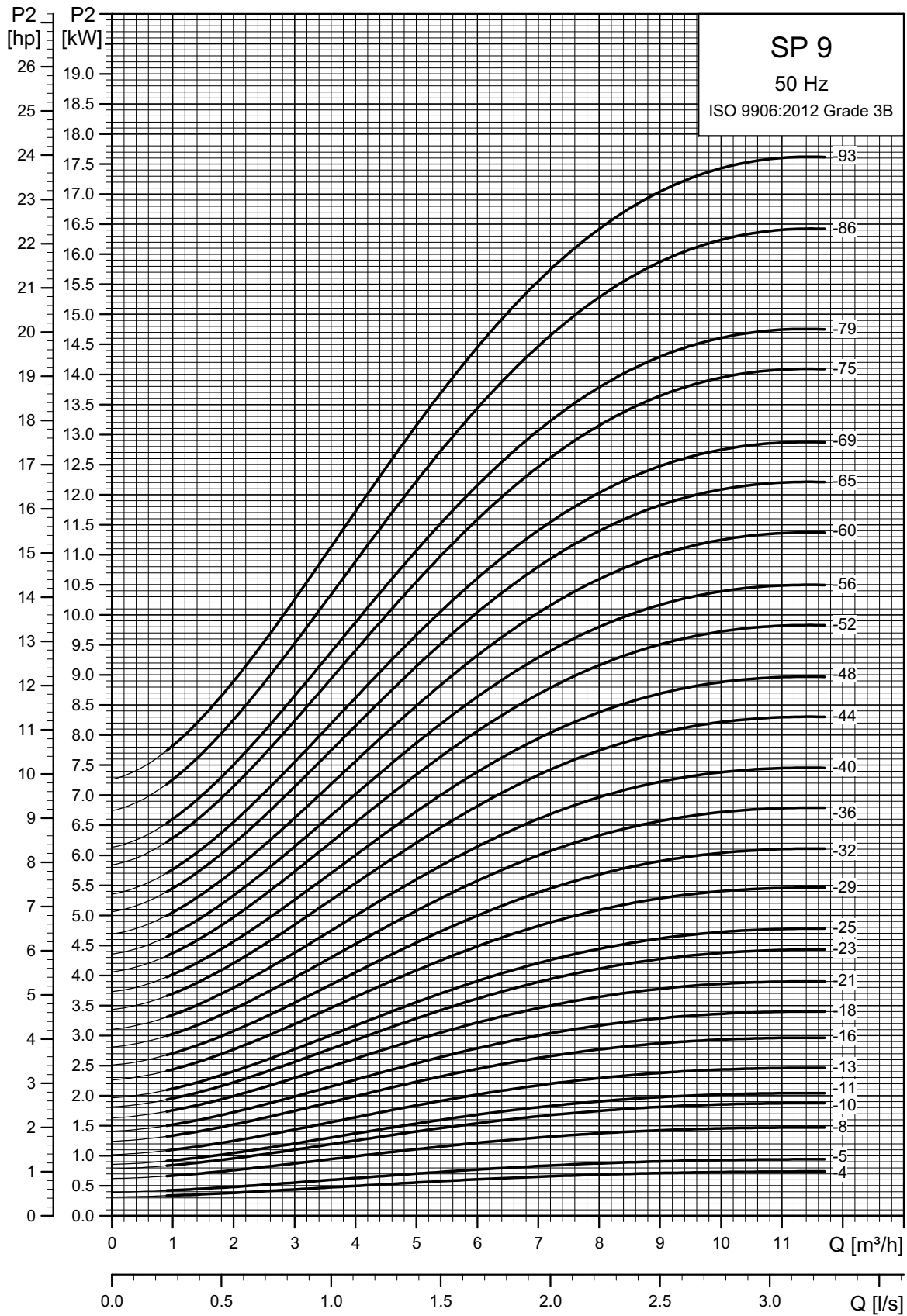

TM06 1425 2414

SP 11

Performance curves

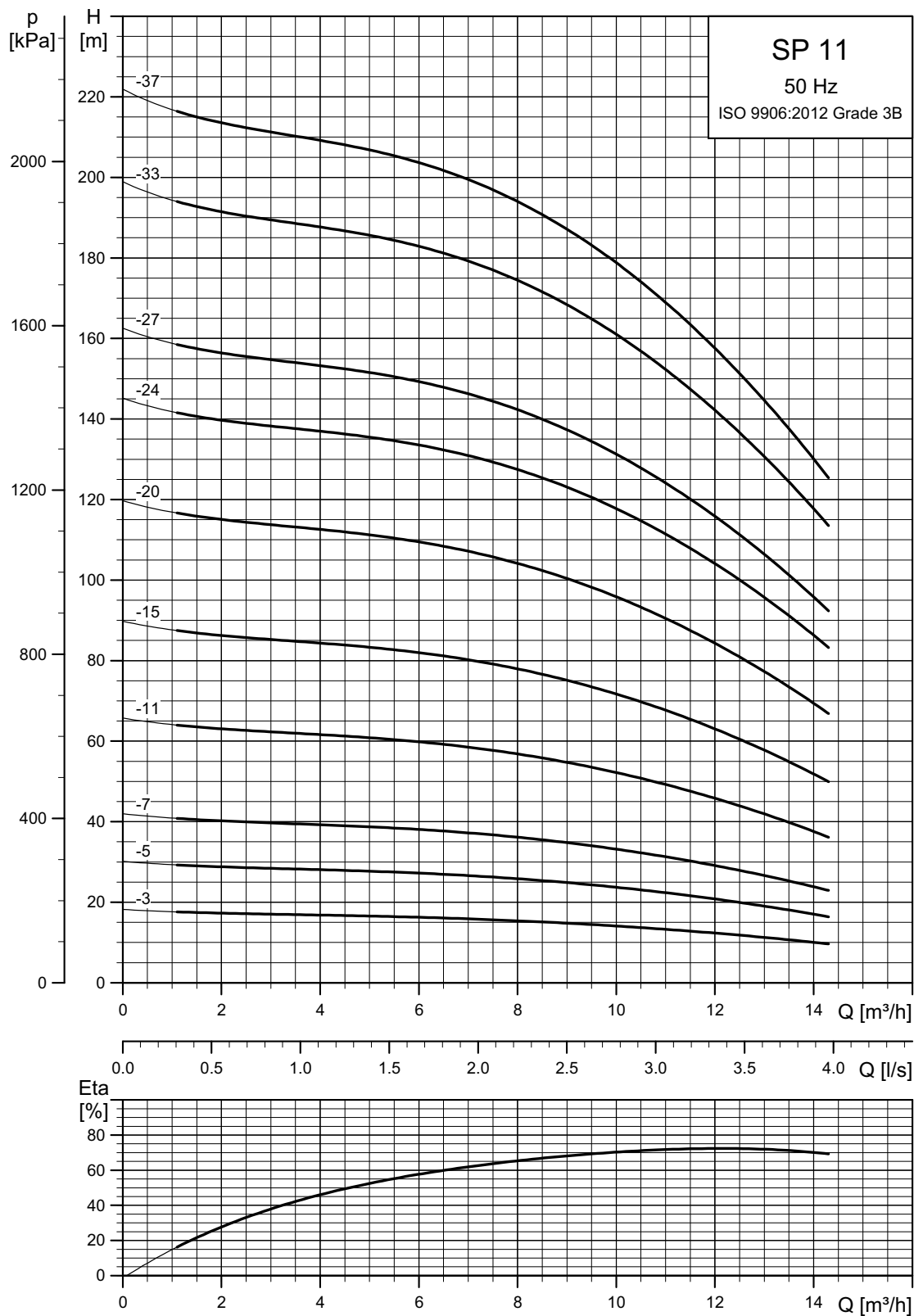

See also section [How to read the curve charts](#) on page 23.

Dimensions and weights

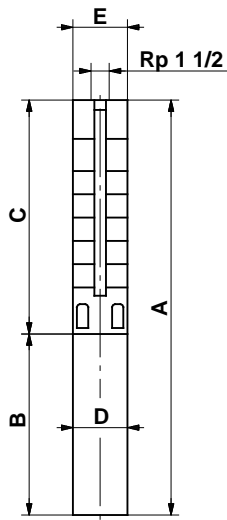

TM00 0956 1196

Pump type	Motor		Dimensions [mm]					Net weight [kg]
	Type	Power [kW]	C	B	A	D	E	
Single-phase, 1 x 230 V / 1 x 240 V								
SP 11-3	MS 402	0.75	463	347	810	95	101	16.0
SP 11-5	MS 402	1.1	613	387	1000	95	101	19.5
SP 11-7	MS 402	1.5	763	387	1150	95	101	21.0
SP 11-11	MS 4000	2.2	1063	577	1640	95	101	34.7
Three-phase, 3 x 220-230 V 50 Hz / 3 x 380-400-415V 50 Hz								
SP 11-3	MS 402	0.75	463	317	780	95	101	14.8
SP 11-5	MS 402	1.1	613	347	960	95	101	17.7
SP 11-7	MS 402	1.5	763	387	1150	95	101	21.0
SP 11-11	MS 402	2.2	1063	387	1450	95	101	25.6
SP 11-3	MS 4000	0.75	463	402	865	95	101	19.3
SP 11-5	MS 4000	1.1	613	417	1030	95	101	21.9
SP 11-7	MS 4000	1.5	763	417	1180	95	101	23.5
SP 11-11	MS 4000	2.2	1063	457	1520	95	101	28.7
SP 11-15	MS 4000	3	1363	497	1860	95	101	33.8
SP 11-20	MS 4000	4	1738	577	2315	95	101	41.9
SP 11-24	MS 4000	5.5	2038	677	2715	95	101	50.0
SP 11-27	MS 4000	5.5	2263	677	2940	95	101	52.3
SP 11-33	MS 4000	7.5	2713	777	3490	95	101	61.2
SP 11-37	MS 4000	7.5	3013	777	3790	95	101	64.4
SP 11-24	MS 6000	5.5	2101	547	2648	139.5	139.5	60.4
SP 11-27	MS 6000	5.5	2326	547	2873	139.5	139.5	62.8
SP 11-33	MS 6000	7.5	2776	577	3353	139.5	139.5	70.5
SP 11-37	MS 6000	7.5	3076	577	3653	139.5	139.5	73.7

E = Maximum diameter of pump inclusive of cable guard and motor.

Note: The pump types above are also available in N- and R-versions. See page 6.
Pumps mounted in sleeve are only available in standard and N-versions.

Power curves

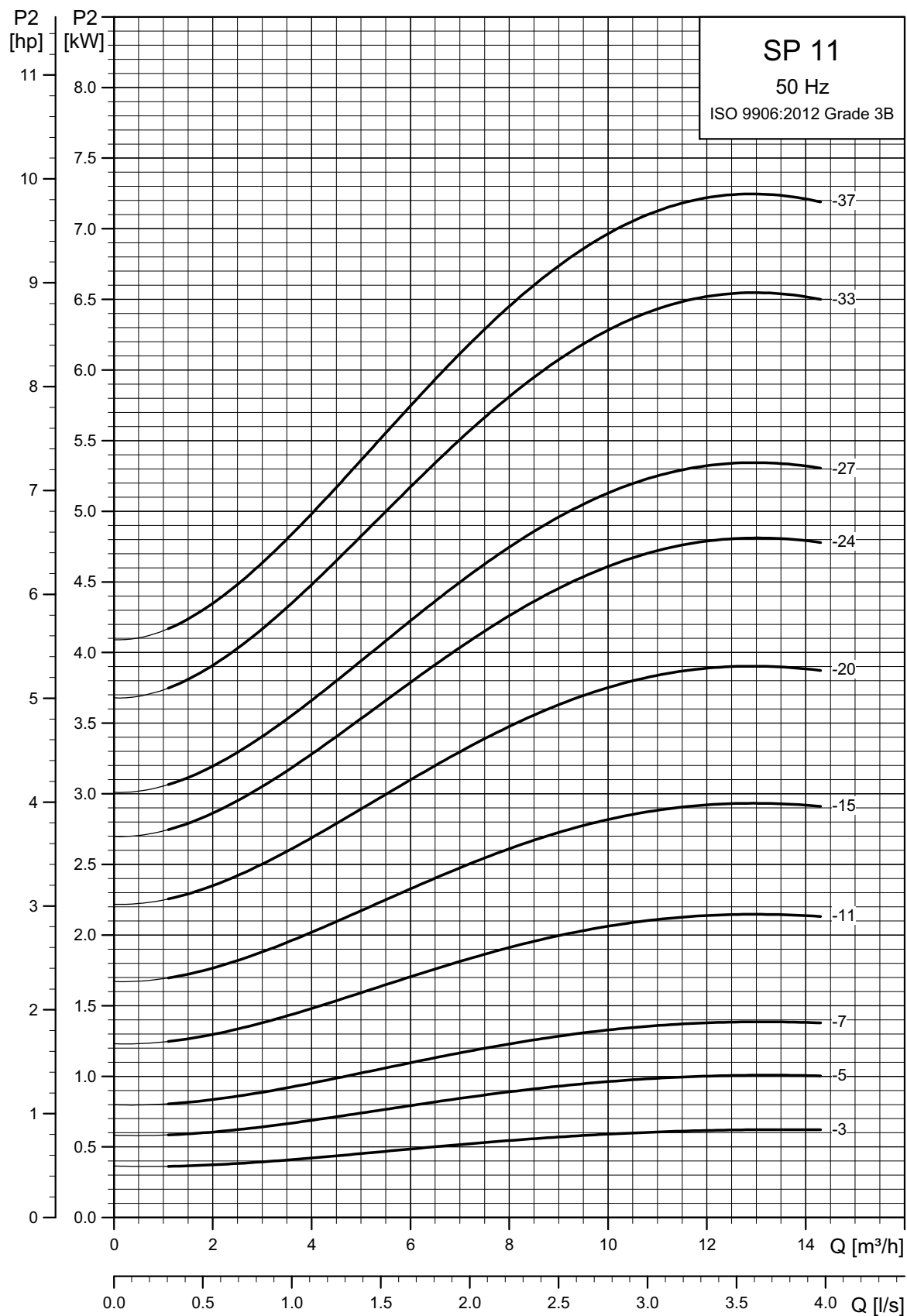

TM06 1426 2414

SP 14

Performance curves

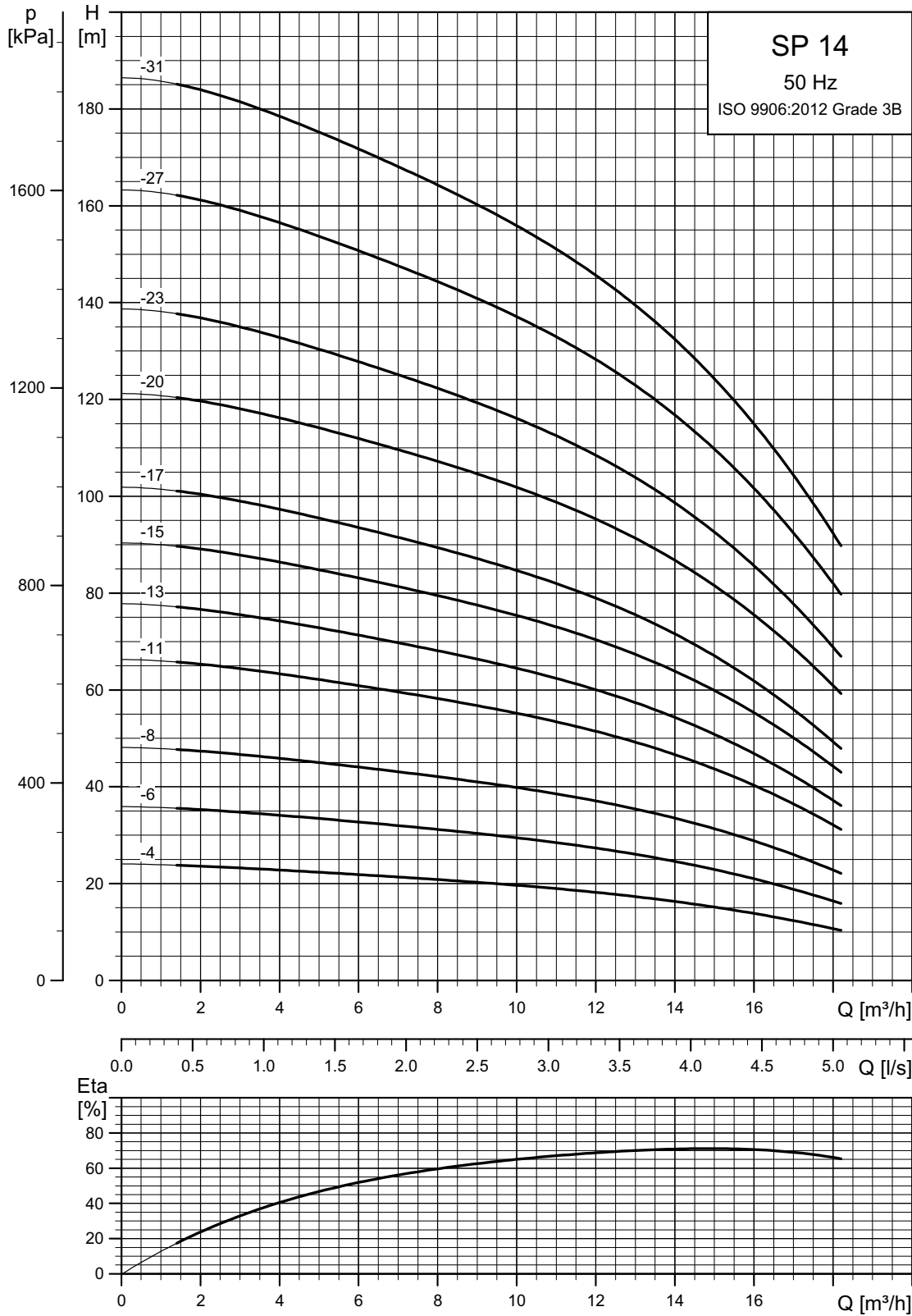

TM06 1427 2414

See also section [How to read the curve charts](#) on page 23.

Dimensions and weights

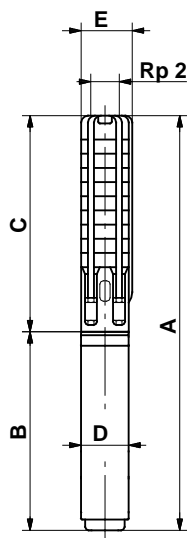

TM00 0957 1196

Pump type	Motor		Dimensions [mm]					Net weight [kg]
	Type	Power [kW]	C	B	A	D	E	
Single-phase, 1 x 230 V / 1 x 240 V								
SP 14-4	MS 402	1.1	538	387	925	95	101	18.7
SP 14-6	MS 402	1.5	688	387	1075	95	101	20.2
SP 14-8	MS 4000	2.2	838	577	1415	95	101	32.3
Three-phase, 3 x 220-230 V 50 Hz / 3 x 380-400-415 V 50 Hz								
SP 14-4	MS 402	1.1	538	347	885	95	101	16.9
SP 14-6	MS 402	1.5	688	387	1075	95	101	20.2
SP 14-8	MS 402	2.2	838	387	1225	95	101	23.2
SP 14-4	MS 4000	1.1	538	417	955	95	101	21.1
SP 14-6	MS 4000	1.5	688	417	1105	95	101	22.7
SP 14-8	MS 4000	2.2	838	457	1295	95	101	26.3
SP 14-11	MS 4000	3	1063	497	1560	95	101	30.6
SP 14-13	MS 4000	3	1213	497	1710	95	101	32.2
SP 14-15	MS 4000	4	1363	577	1940	95	101	37.8
SP 14-17	MS 4000	4	1513	577	2090	95	101	39.5
SP 14-20	MS 4000	5.5	1738	677	2415	95	101	46.9
SP 14-23	MS 4000	5.5	1963	677	2640	95	101	49.2
SP 14-27	MS 4000	7.5	2263	777	3040	95	101	56.4
SP 14-31	MS 4000	7.5	2563	777	3340	95	101	59.6
SP 14-20	MS 6000	5.5	1801	547	2348	139.5	139.5	57.3
SP 14-23	MS 6000	5.5	2026	547	2573	139.5	139.5	59.6
SP 14-27	MS 6000	7.5	2326	577	2903	139.5	139.5	65.8
SP 14-31	MS 6000	7.5	2626	577	3203	139.5	139.5	69.0

E = Maximum diameter of pump inclusive of cable guard and motor.

Note: The pump types above are also available in N- and R-versions. See page 6.
Pumps mounted in sleeve are only available in standard and N-versions.

Power curves

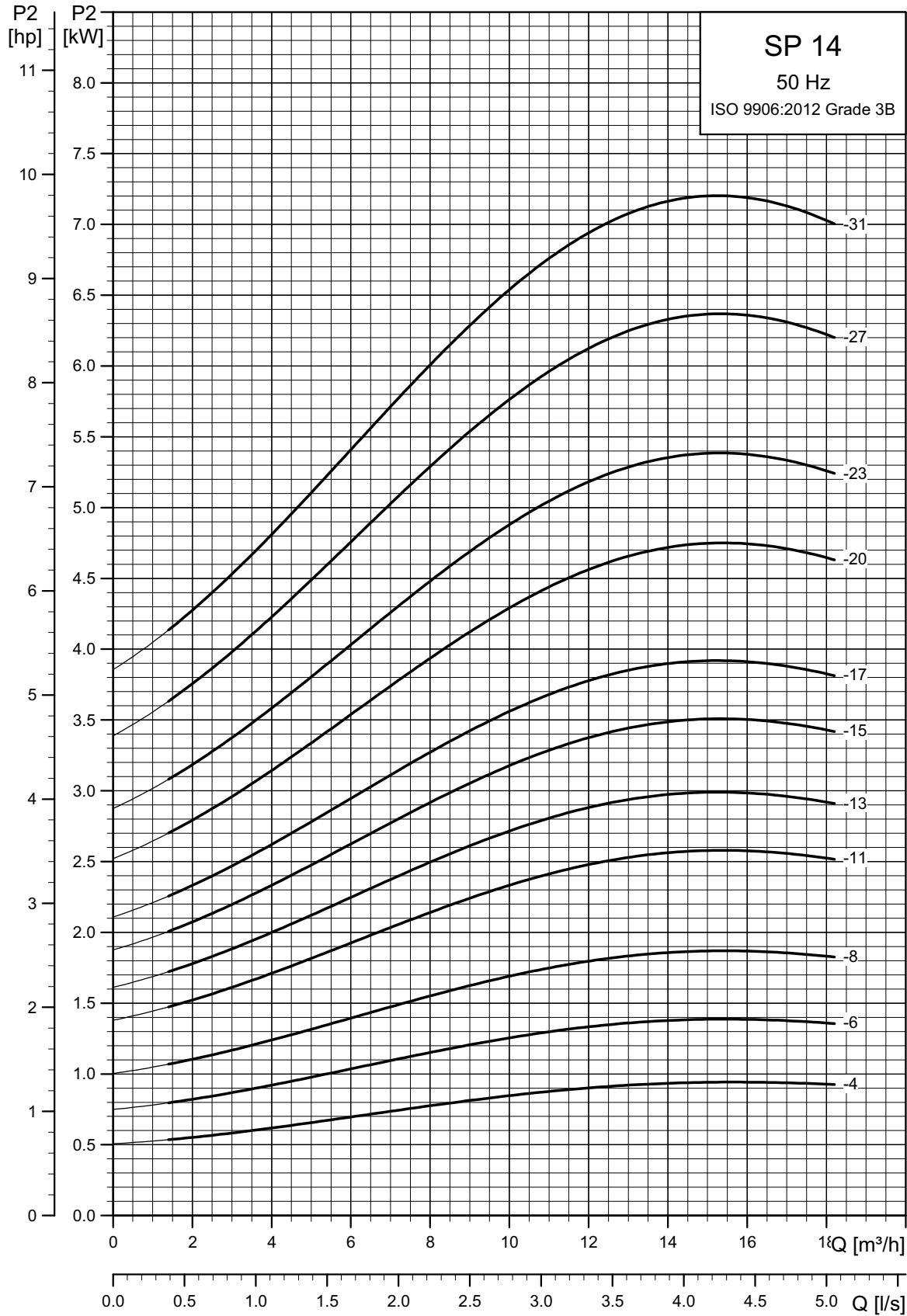

TM06 1428 2414

SP 17

Performance curves

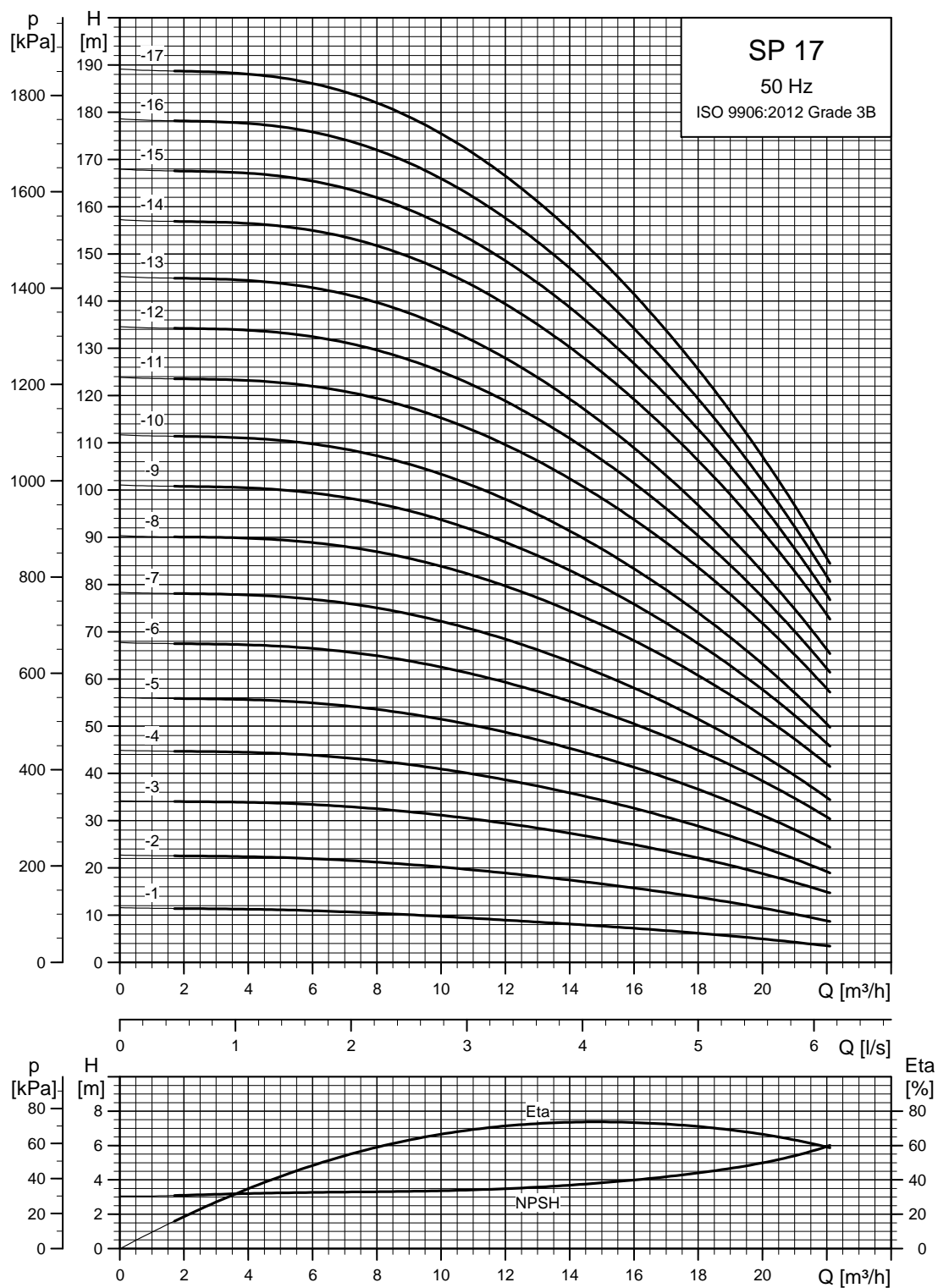

See also section [How to read the curve charts](#) on page 23.

TM01 8757 4702

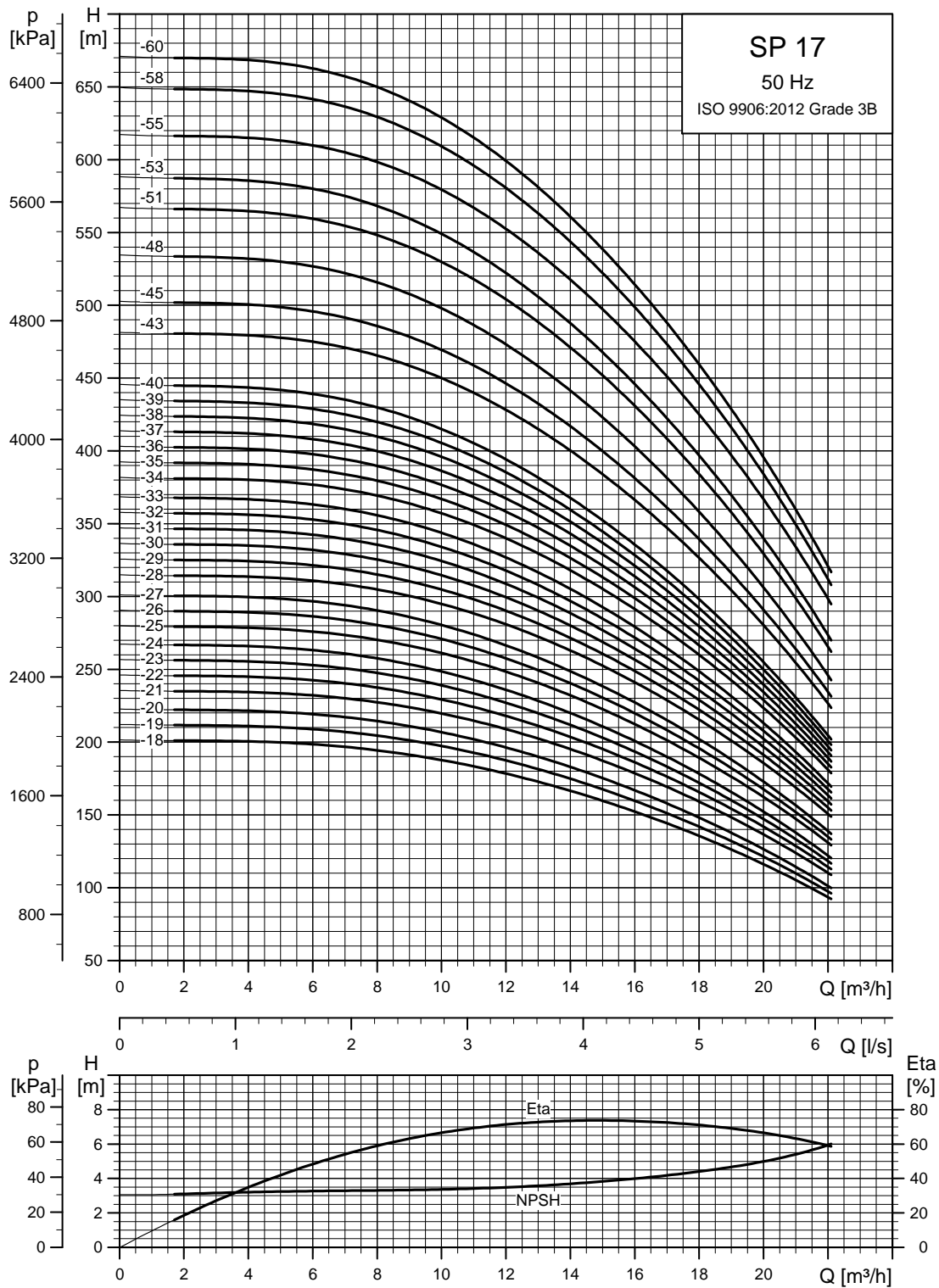

TM01 8758 4702

See also section [How to read the curve charts](#) on page 23.

Dimensions and weights

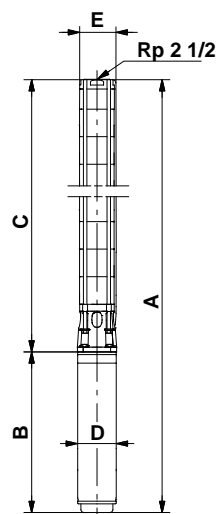

TM01 2435 1798

SP 17-43 to SP 17-60 are mounted in sleeve for R 3 connection.

The pump types listed are also available in N- and R-versions. See page 6.

Pumps mounted in sleeve are only available in standard and N-versions.

Other types of connection are possible by means of connecting pieces. See page 108.

* Maximum diameter of pump with one motor cable.

** Maximum diameter of pump with two motor cables.

Pump type	Motor		Dimensions [mm]					Net weight [kg]	
	Type	Power [kW]	C	B	A	D	E*		E**
Single-phase, 1 x 230 V									
SP 17-1	MS 402	0.55	324	317	641	95	134	12	
SP 17-1	MS 4000	2.2	324	577	901	95	134	26	
SP 17-2	MS 402	1.1	384	387	771	95	134	17	
SP 17-2	MS 4000	2.2	384	577	961	95	134	27	
SP 17-3	MS 4000	2.2	444	577	1021	95	134	28	
SP 17-4	MS 4000	2.2	504	577	1081	95	134	30	
Three-phase, 3 x 230 V / 3 x 400 V									
SP 17-1	MS 402	0.55	324	282	606	95	134	11	
SP 17-1	MS 4000	0.75	324	402	726	95	134	18	
SP 17-2	MS 402	1.1	384	347	731	95	134	15	
SP 17-2	MS 4000	1.1	384	417	801	95	134	20	
SP 17-3	MS 402	2.2	444	387	831	95	134	19	
SP 17-3	MS 4000	2.2	444	457	901	95	134	23	
SP 17-4	MS 402	2.2	504	387	891	95	134	21	
SP 17-4	MS 4000	2.2	504	457	961	95	134	25	
SP 17-5	MS 4000	3.0	564	497	1061	95	134	27	
SP 17-6	MS 4000	4.0	624	577	1201	95	134	32	
SP 17-7	MS 4000	4.0	684	577	1261	95	134	34	
SP 17-8	MS 4000	5.5	744	677	1421	95	134	40	
SP 17-9	MS 4000	5.5	804	677	1481	95	134	42	
SP 17-10	MS 4000	5.5	864	677	1541	95	134	43	
SP 17-11	MS 4000	7.5	924	777	1701	95	134	50	
SP 17-12	MS 4000	7.5	984	777	1761	95	134	51	
SP 17-13	MS 4000	7.5	1044	777	1821	95	134	53	
SP 17-8	MS 6000	5.5	763	544	1307	139.5	142	144	49
SP 17-9	MS 6000	5.5	823	544	1367	139.5	142	144	50
SP 17-10	MS 6000	5.5	883	544	1427	139.5	142	144	52
SP 17-11	MS 6000	7.5	943	574	1517	139.5	142	144	56
SP 17-12	MS 6000	7.5	1003	574	1577	139.5	142	144	58
SP 17-13	MS 6000	7.5	1063	574	1637	139.5	142	144	59
SP 17-14	MS 6000	9.2	1123	604	1727	139.5	142	144	66
SP 17-15	MS 6000	9.2	1183	604	1787	139.5	142	144	67
SP 17-16	MS 6000	9.2	1243	604	1847	139.5	142	144	69
SP 17-17	MS 6000	9.2	1303	604	1907	139.5	142	144	70
SP 17-18	MS 6000	11	1363	634	1997	139.5	142	144	75
SP 17-19	MS 6000	11	1423	634	2057	139.5	142	144	76
SP 17-20	MS 6000	11	1483	634	2117	139.5	142	144	77
SP 17-21	MS 6000	13	1543	664	2207	139.5	142	144	82
SP 17-22	MS 6000	13	1603	664	2267	139.5	142	144	83
SP 17-23	MS 6000	13	1663	664	2327	139.5	142	144	84
SP 17-24	MS 6000	13	1723	664	2387	139.5	142	144	86
SP 17-25	MS 6000	15	1783	699	2482	139.5	142	144	91
SP 17-26	MS 6000	15	1843	699	2542	139.5	142	144	92
SP 17-27	MS 6000	15	1903	699	2602	139.5	142	144	94
SP 17-28	MS 6000	18.5	1963	754	2717	139.5	142	144	101
SP 17-29	MS 6000	18.5	2023	754	2777	139.5	142	144	102
SP 17-30	MS 6000	18.5	2083	754	2837	139.5	142	144	103
SP 17-31	MS 6000	18.5	2143	754	2897	139.5	142	144	105
SP 17-32	MS 6000	18.5	2203	754	2957	139.5	142	144	106
SP 17-33	MS 6000	18.5	2263	754	3017	139.5	142	144	108
SP 17-34	MS 6000	22	2323	814	3137	139.5	142	144	115
SP 17-35	MS 6000	22	2383	814	3197	139.5	142	144	116
SP 17-36	MS 6000	22	2443	814	3257	139.5	142	144	118
SP 17-37	MS 6000	22	2503	814	3317	139.5	142	144	119
SP 17-38	MS 6000	22	2563	814	3377	139.5	142	144	120
SP 17-39	MS 6000	22	2623	814	3437	139.5	142	144	122
SP 17-40	MS 6000	22	2683	814	3497	139.5	142	144	123
SP 17-43	MS 6000	26	3215	874	4089	139.5	175	181	164
SP 17-45	MS 6000	26	3335	874	4209	139.5	175	181	167
SP 17-48	MS 6000	26	3515	874	4389	139.5	175	181	173
SP 17-51	MS 6000	30	3695	944	4639	139.5	175	181	186
SP 17-53	MS 6000	30	3815	944	4759	139.5	175	181	189
SP 17-55	MMS 6	37	3935	1312	5247	144	175	181	234
SP 17-58	MMS 6	37	4115	1312	5427	144	175	181	240
SP 17-60	MMS 6	37	4235	1312	5547	144	175	181	243

Power curves

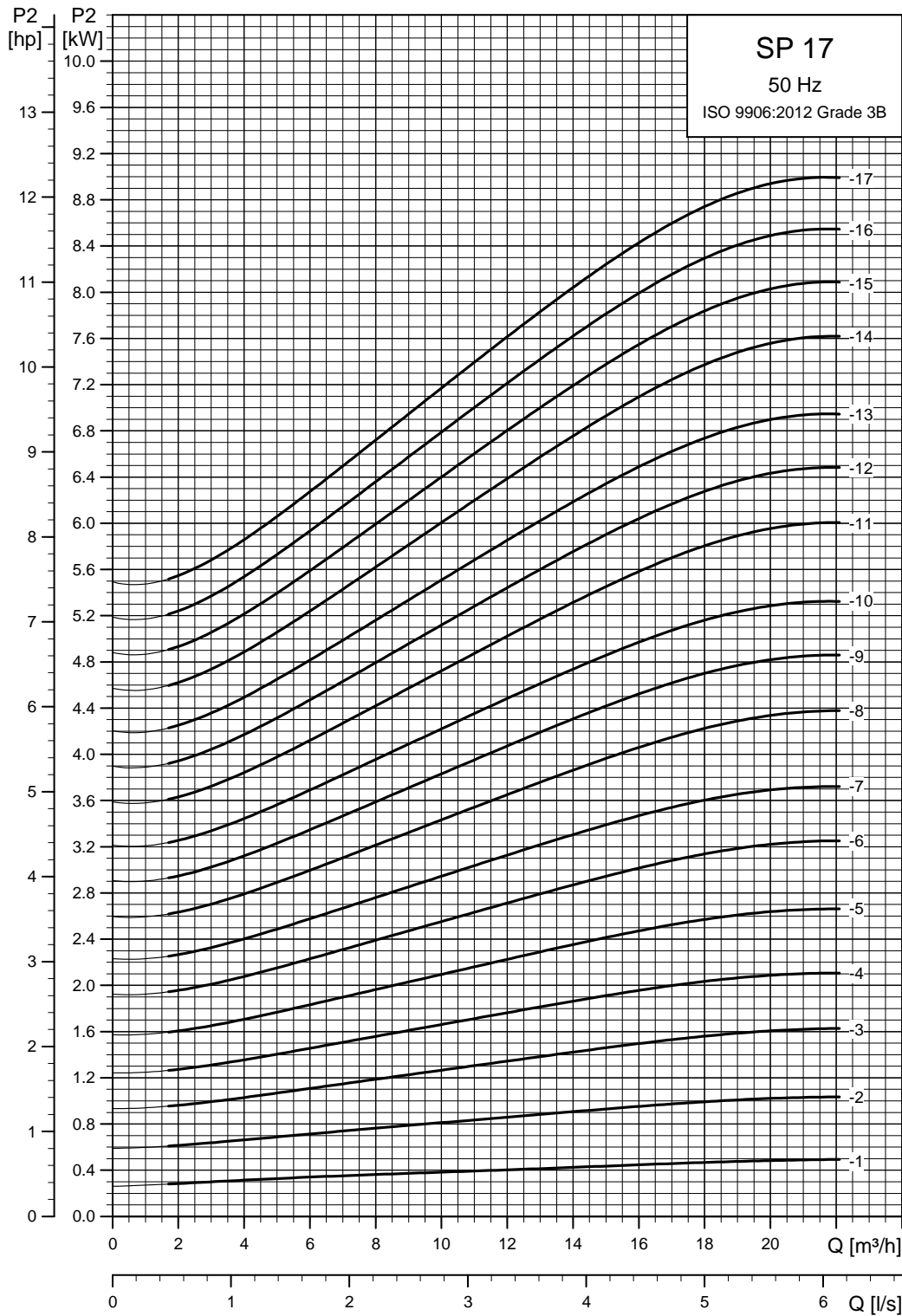

TM01 8759 4702

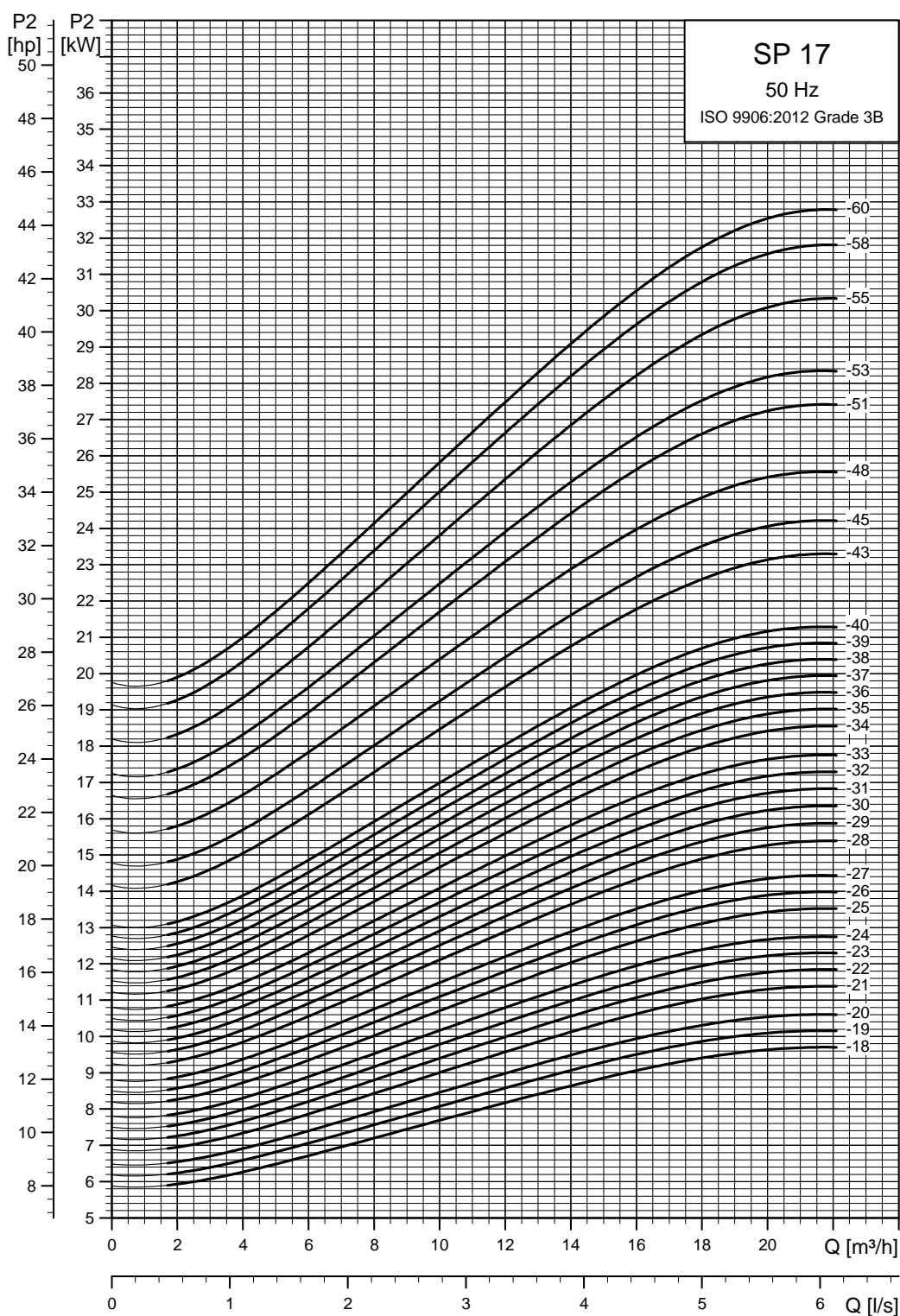

SP 30

Performance curves

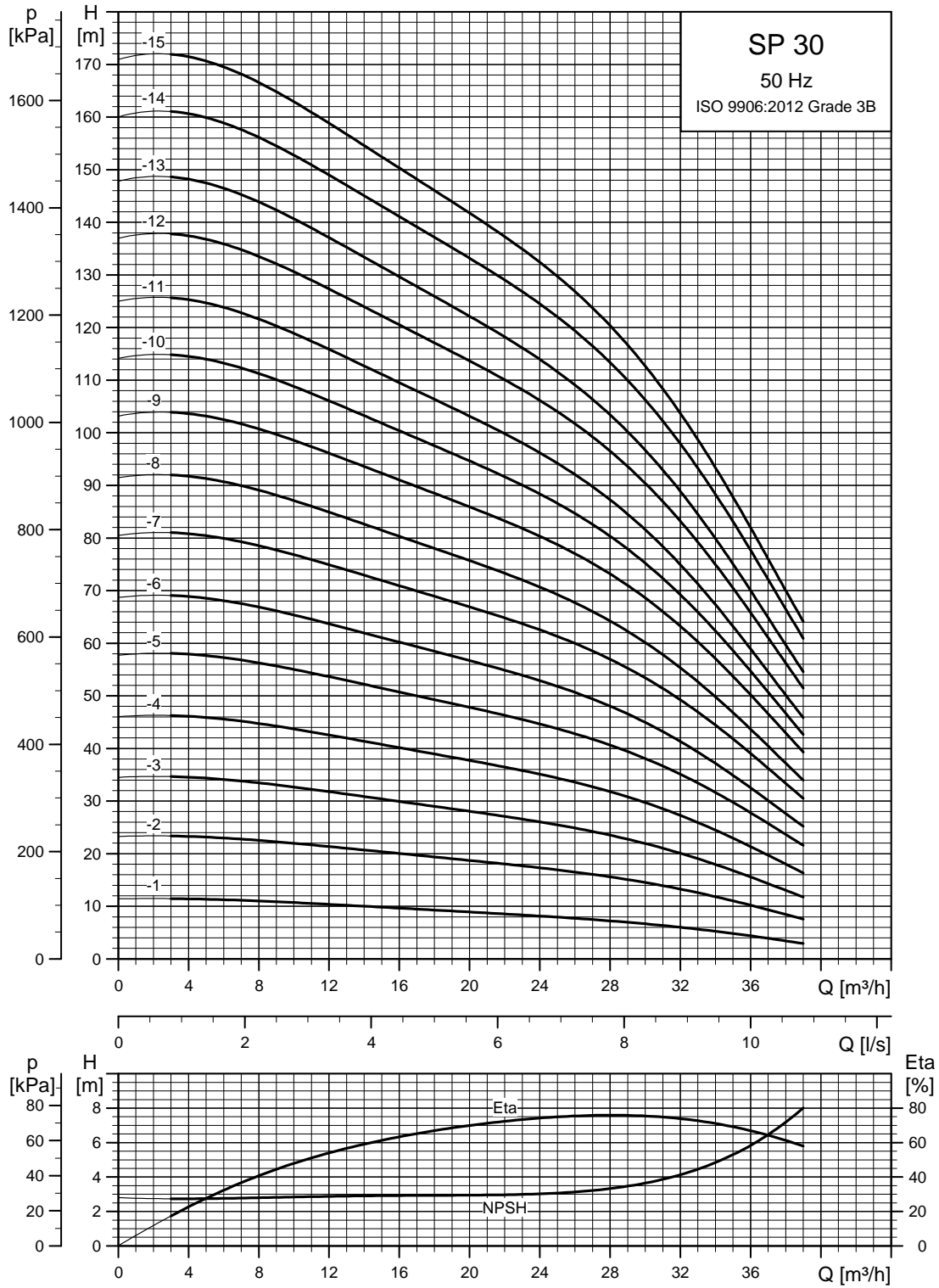

See also [Maximum start/stop frequency](#), page 19.

TM01 8761 4702

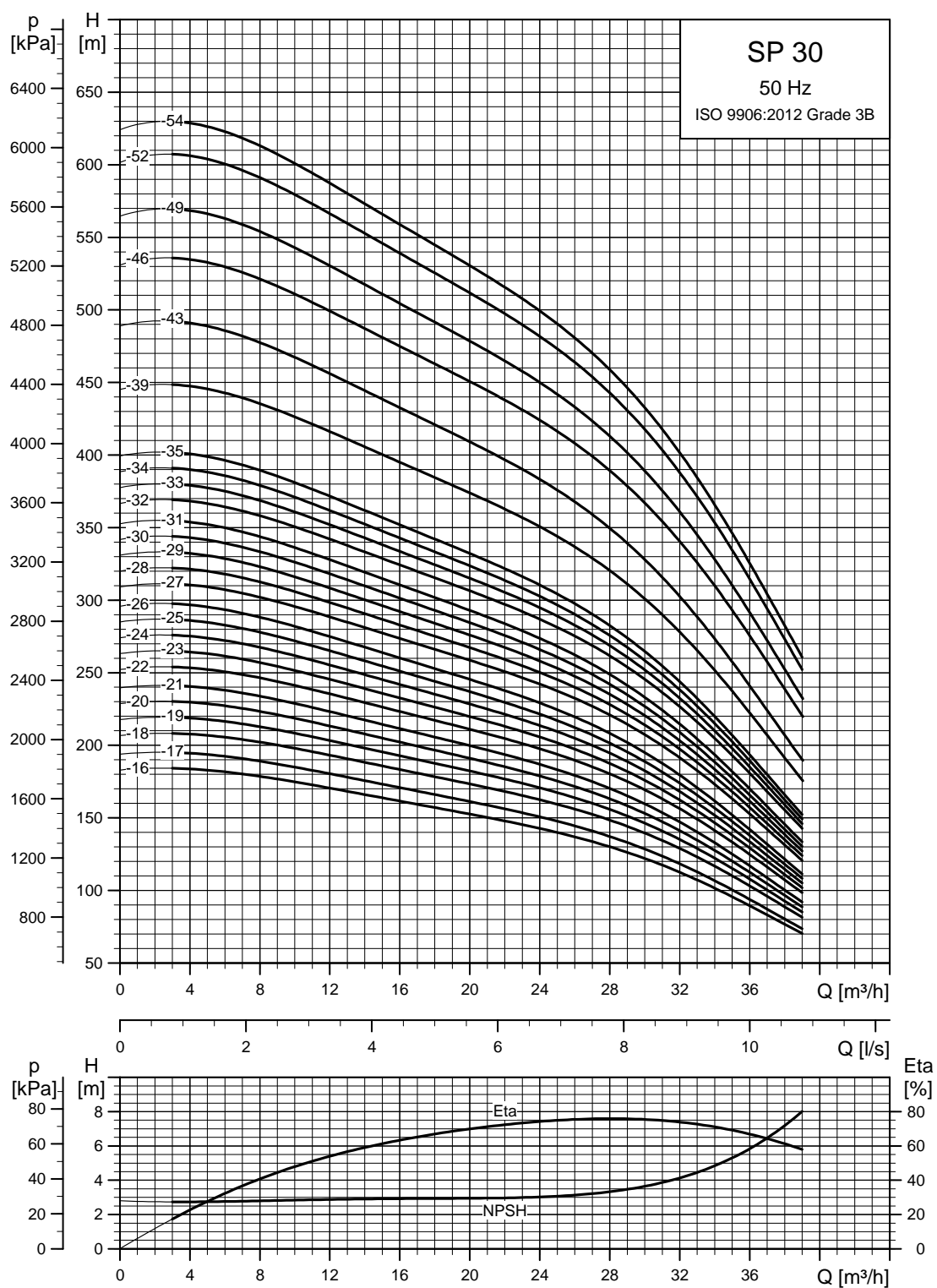

TM01 8762 4702

See also [Maximum start/stop frequency](#), page 19.

Dimensions and weights

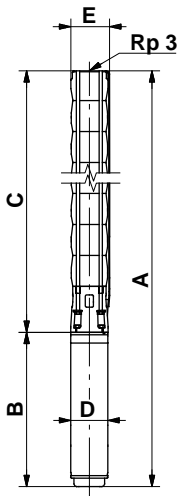

TM00 0960 1196

SP 30-39 to SP 30-54 are mounted in sleeve for R 3 connection.

Pump type	Motor		Dimensions [mm]					Net weight [kg]	
	Type	Power [kW]	C	B	A	D	E*		E**
Single-phase, 1 x 230 V									
SP 30-1	MS 402	1.1	358	387	745	95	134	16	
SP 30-1	MS 4000	2.2	358	577	935	95	134	27	
SP 30-2	MS 4000	2.2	454	577	1031	95	134	29	
Three-phase, 3 x 230 V / 3 x 400 V									
SP 30-1	MS 402	1.1	358	347	705	95	134	15	
SP 30-1	MS 4000	1.1	358	417	775	95	134	20	
SP 30-2	MS 402	2.2	387	457	844	95	134	19	
SP 30-2	MS 4000	2.2	454	457	911	95	134	24	
SP 30-3	MS 4000	3.0	550	497	1047	95	134	26	
SP 30-4	MS 4000	4.0	646	577	1223	95	134	32	
SP 30-5	MS 4000	5.5	742	677	1419	95	134	39	
SP 30-6	MS 4000	5.5	838	677	1515	95	134	41	
SP 30-7	MS 4000	7.5	934	777	1711	95	134	48	
SP 30-8	MS 4000	7.5	1030	777	1807	95	134	50	
SP 30-5	MS 6000	5.5	761	544	1305	139.5	142	144	47
SP 30-6	MS 6000	5.5	857	544	1401	139.5	142	144	49
SP 30-7	MS 6000	7.5	953	574	1527	139.5	142	144	55
SP 30-8	MS 6000	7.5	1049	574	1623	139.5	142	144	57
SP 30-9	MS 6000	9.2	1145	604	1749	139.5	142	144	64
SP 30-10	MS 6000	9.2	1241	604	1845	139.5	142	144	66
SP 30-11	MS 6000	9.2	1337	604	1941	139.5	142	144	68
SP 30-12	MS 6000	11	1433	634	2067	139.5	142	144	73
SP 30-13	MS 6000	11	1529	634	2163	139.5	142	144	75
SP 30-14	MS 6000	13	1625	664	2289	139.5	142	144	80
SP 30-15	MS 6000	13	1721	664	2385	139.5	142	144	82
SP 30-16	MS 6000	15	1817	699	2516	139.5	142	144	88
SP 30-17	MS 6000	15	1913	699	2612	139.5	142	144	90
SP 30-18	MS 6000	18.5	2009	754	2763	139.5	142	144	97
SP 30-19	MS 6000	18.5	2105	754	2859	139.5	142	144	99
SP 30-20	MS 6000	18.5	2201	754	2955	139.5	142	144	101
SP 30-21	MS 6000	18.5	2297	754	3051	139.5	142	144	103
SP 30-22	MS 6000	22	2393	814	3207	139.5	142	144	111
SP 30-23	MS 6000	22	2489	814	3303	139.5	142	144	113
SP 30-24	MS 6000	22	2585	814	3399	139.5	142	144	115
SP 30-25	MS 6000	22	2681	814	3495	139.5	142	144	117
SP 30-26	MS 6000	22	2777	814	3591	139.5	142	144	119
SP 30-27	MS 6000	26	2873	874	3747	139.5	142	144	126
SP 30-28	MS 6000	26	2969	874	3843	139.5	142	144	128
SP 30-29	MS 6000	26	3065	874	3939	139.5	142	144	130
SP 30-30	MS 6000	26	3161	874	4035	139.5	142	144	132
SP 30-31	MS 6000	26	3257	874	4131	139.5	142	144	134
SP 30-32	MS 6000	30	3353	944	4297	139.5	142	144	144
SP 30-33	MS 6000	30	3449	944	4393	139.5	142	144	146
SP 30-34	MS 6000	30	3545	944	4489	139.5	142	144	148
SP 30-35	MS 6000	30	3641	944	4585	139.5	142	144	150
SP 30-39	MMS 6	37	4377	1312	3982	144	175	181	248
SP 30-43	MMS 6	37	4761	1312	4095	144	175	181	259
SP 30-46	MMS 8000	45	4993	1270	4781	192	192	192	326
SP 30-49	MMS 8000	45	5281	1270	5007	192	192	192	334
SP 30-52	MMS 8000	55	5569	1350	5652	192	192	192	357
SP 30-54	MMS 8000	55	5761	1350	5878	192	192	192	362

The pump types above are also available in N- and R-versions. See page 6.
 Pumps mounted in sleeve are only available in standard and N-versions.
 Other types of connection are possible by means of connecting pieces. See page 108.

Power curves

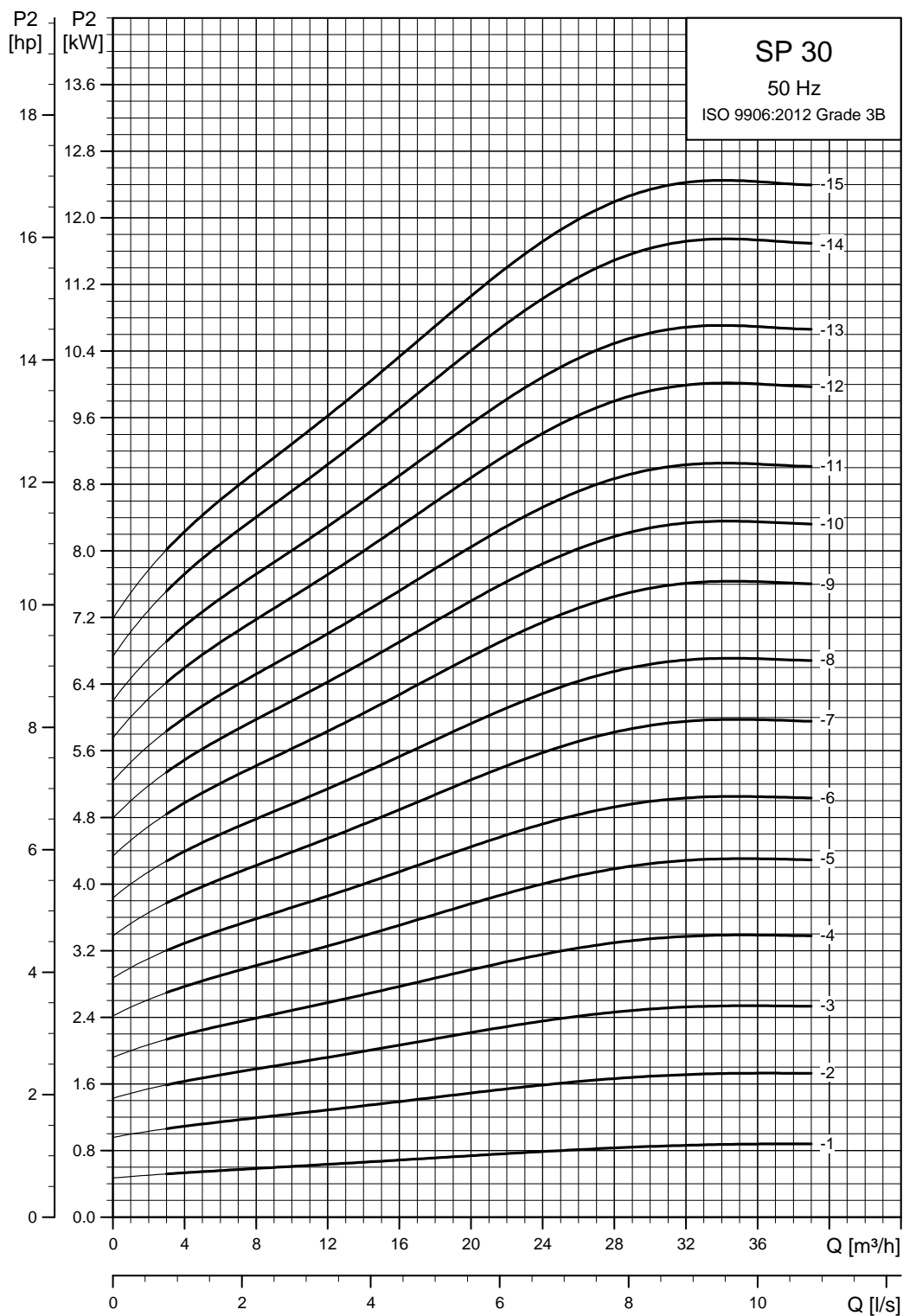

See also section [How to read the curve charts](#) on page 23.

TM01 8763 4702

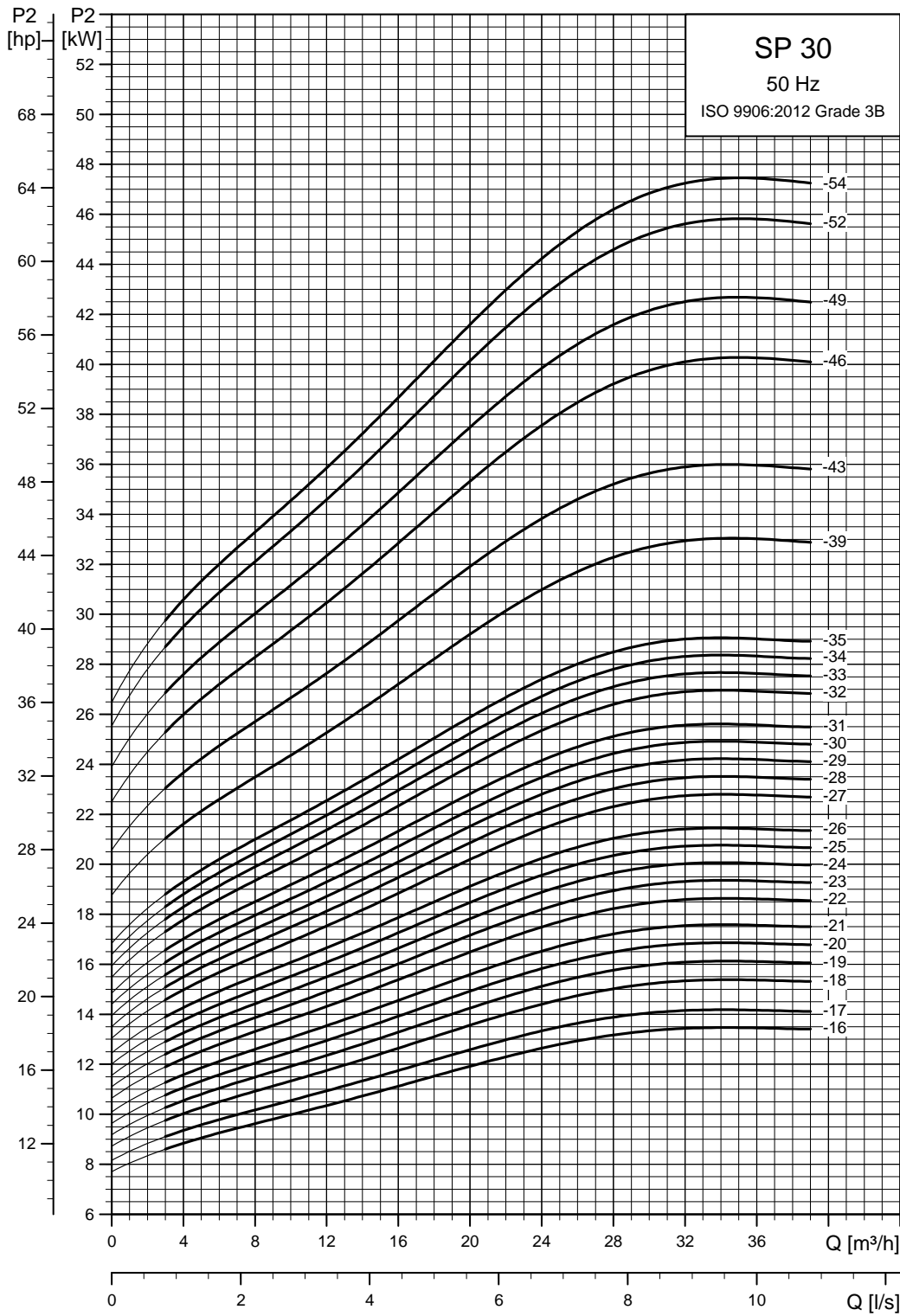

TM01 8764 4702

SP 46

Performance curves

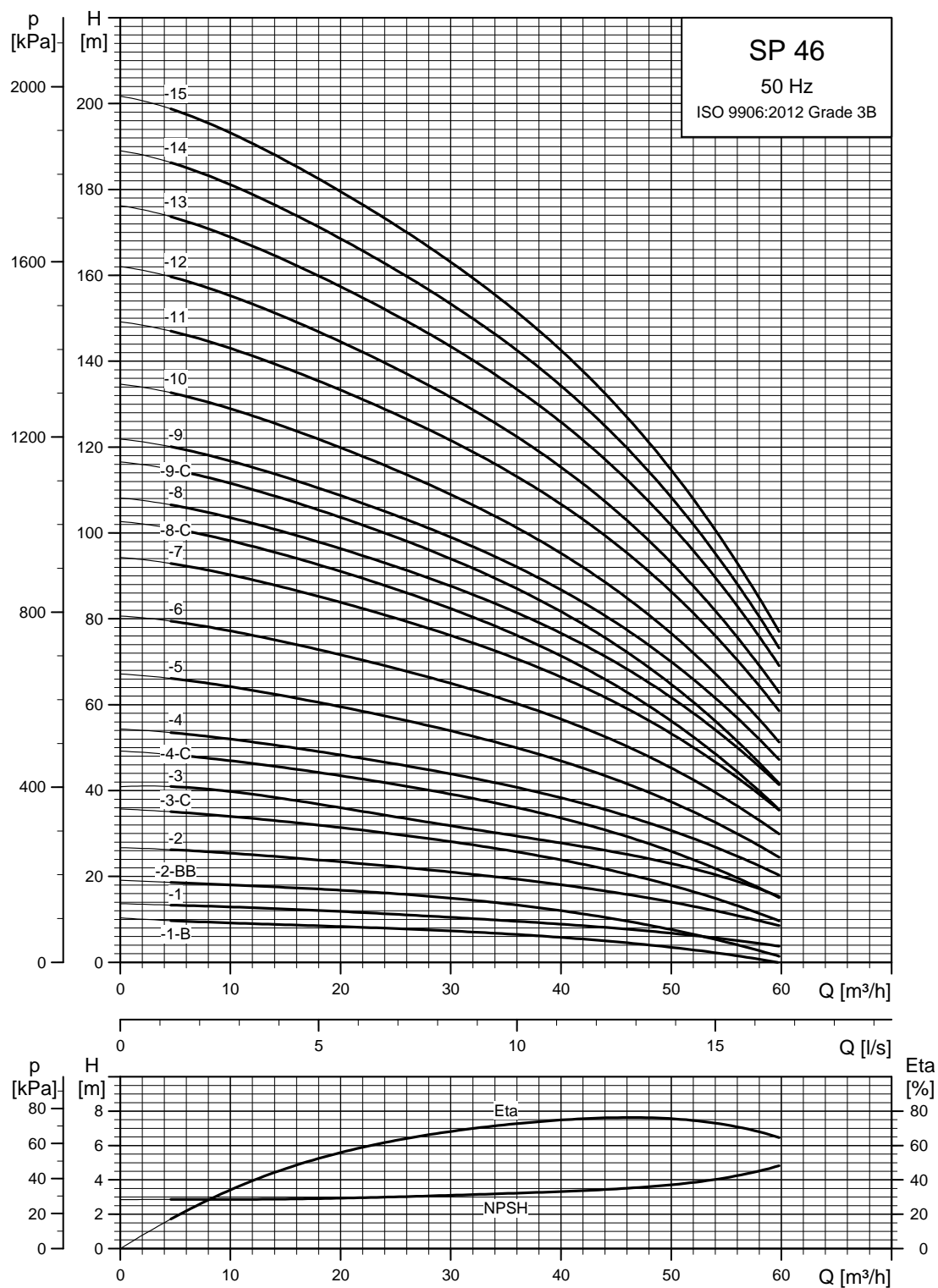

See also section [How to read the curve charts](#) on page 23.

TM01 8765 4702

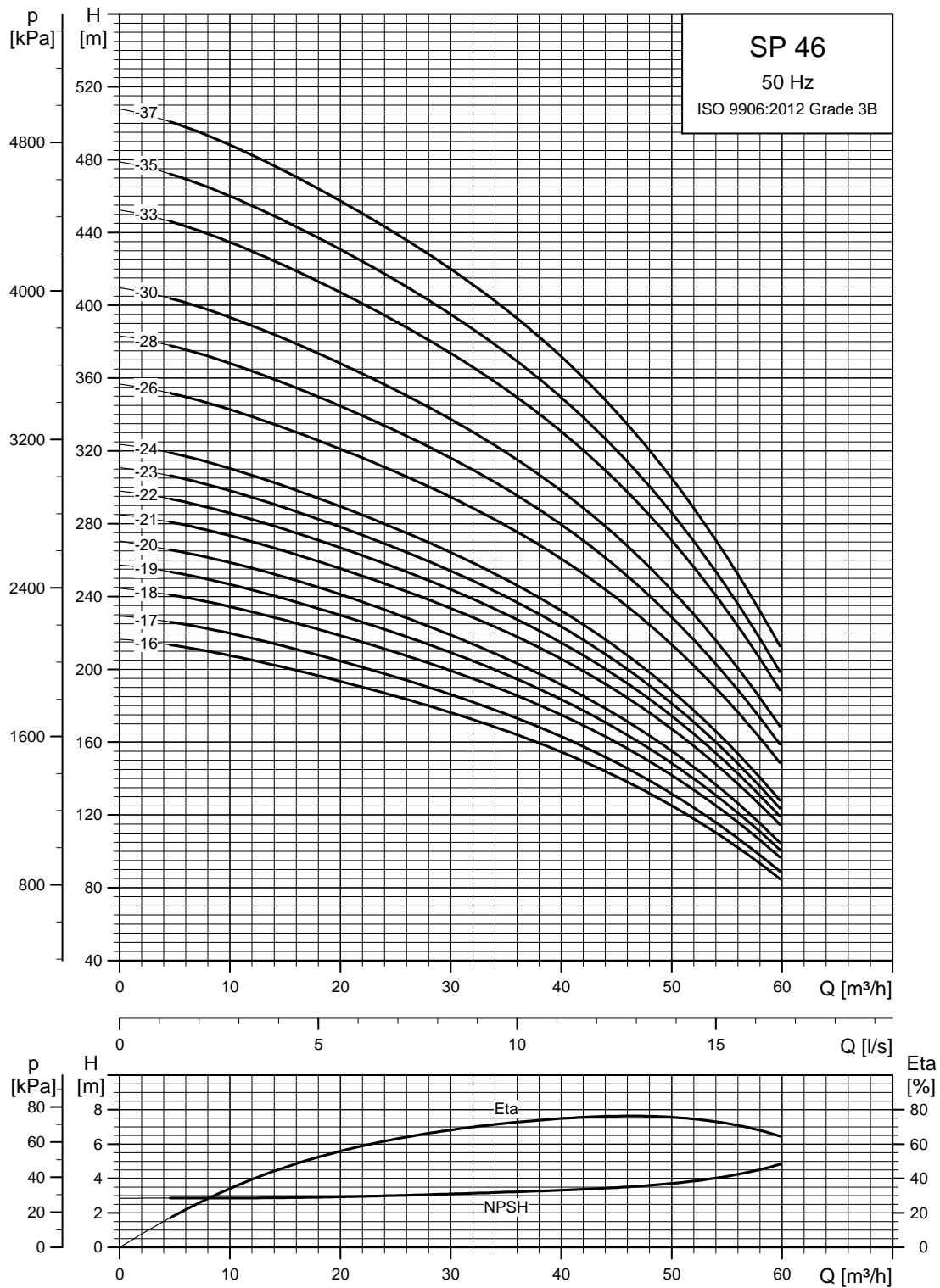

TM01 8766 4702

See also section [How to read the curve charts](#) on page 23.

Dimensions and weights

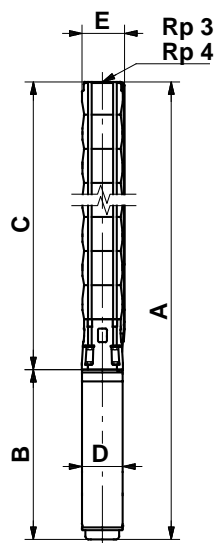

SP 46-26 to SP 46-37 are mounted in sleeve for R 4 connection.

TM00 0961 1196

Pump type	Motor		Dimensions [mm]					Net weight [kg]	
	Type	Power [kW]	Rp 3/Rp 4 connection						
			A	C	E*	E**	B		D
Three-phase, 3 x 230 V / 3 x 400 V									
SP 46-1-B	MS 4000	1.1	795	378	146		417	95	21
SP 46-1	MS 4000	2.2	835	378	146		457	95	23
SP 46-2-BB	MS 4000	2.2	948	491	146		457	95	26
SP 46-2	MS 4000	3.0	988	491	146		497	95	27
SP 46-3-C	MS 4000	4.0	1181	604	146		577	95	33
SP 46-3	MS 4000	5.5	1281	604	146		677	95	38
SP 46-4-C	MS 4000	5.5	1394	717	146		677	95	40
SP 46-4	MS 4000	7.5	1494	717	146		777	95	45
SP 46-5	MS 4000	7.5	1607	830	146		777	95	48
SP 46-3	MS 6000	5.5	1164	620	148	151	544	139.5	48
SP 46-4-C	MS 6000	5.5	1277	733	148	151	544	139.5	51
SP 46-4	MS 6000	7.5	1307	733	148	151	574	139.5	54
SP 46-5	MS 6000	7.5	1420	846	148	151	574	139.5	57
SP 46-6	MS 6000	9.2	1563	959	148	151	604	139.5	64
SP 46-7	MS 6000	11	1706	1072	148	151	634	139.5	70
SP 46-8-C	MS 6000	11	1819	1185	148	151	634	139.5	72
SP 46-8	MS 6000	13	1849	1185	148	151	664	139.5	75
SP 46-9-C	MS 6000	13	1962	1298	148	151	664	139.5	78
SP 46-9	MS 6000	15	1997	1298	148	151	699	139.5	82
SP 46-10	MS 6000	15	2110	1411	148	151	699	139.5	84
SP 46-11	MS 6000	18.5	2278	1524	148	151	754	139.5	92
SP 46-12	MS 6000	18.5	2391	1637	148	151	754	139.5	94
SP 46-13	MS 6000	22	2580	1766	148	151	814	139.5	103
SP 46-14	MS 6000	22	2693	1879	148	151	814	139.5	106
SP 46-15	MS 6000	22	2806	1992	148	151	814	139.5	108
SP 46-16	MS 6000	26	2979	2105	148	151	874	139.5	116
SP 46-17	MS 6000	26	3092	2218	148	151	874	139.5	118
SP 46-18	MS 6000	30	3275	2331	148	151	944	139.5	129
SP 46-19	MS 6000	30	3388	2444	148	151	944	139.5	131
SP 46-20	MS 6000	30	3501	2557	148	151	944	139.5	134
SP 46-21	MMS 6	37	3982	2670	150	153	1312	144	176
SP 46-22	MMS 6	37	4095	2783	150	153	1312	144	179
SP 46-23	MMS 6	37	4208	2896	150	153	1312	144	181
SP 46-24	MMS 6	37	4321	3009	150	153	1312	144	183
SP 46-26	MMS 8000	45	4781	3511	192	192	1270	192	278
SP 46-28	MMS 8000	45	5007	3737	192	192	1270	192	284
SP 46-30	MMS 8000	45	5233	3963	192	192	1270	192	290
SP 46-33	MMS 8000	55	5652	4302	192	192	1350	192	314
SP 46-35	MMS 8000	55	5878	4528	192	192	1350	192	320
SP 46-37	MMS 8000	63	6244	4754	192	192	1490	192	352

* Maximum diameter of pump with one motor cable.

** Maximum diameter of pump with two motor cables.

The pump types above are also available in N- and R-versions. See page 6.

Pumps mounted in sleeve are only available in standard and N-versions.

Other types of connection are possible by means of connecting pieces. See page 108.

Power curves

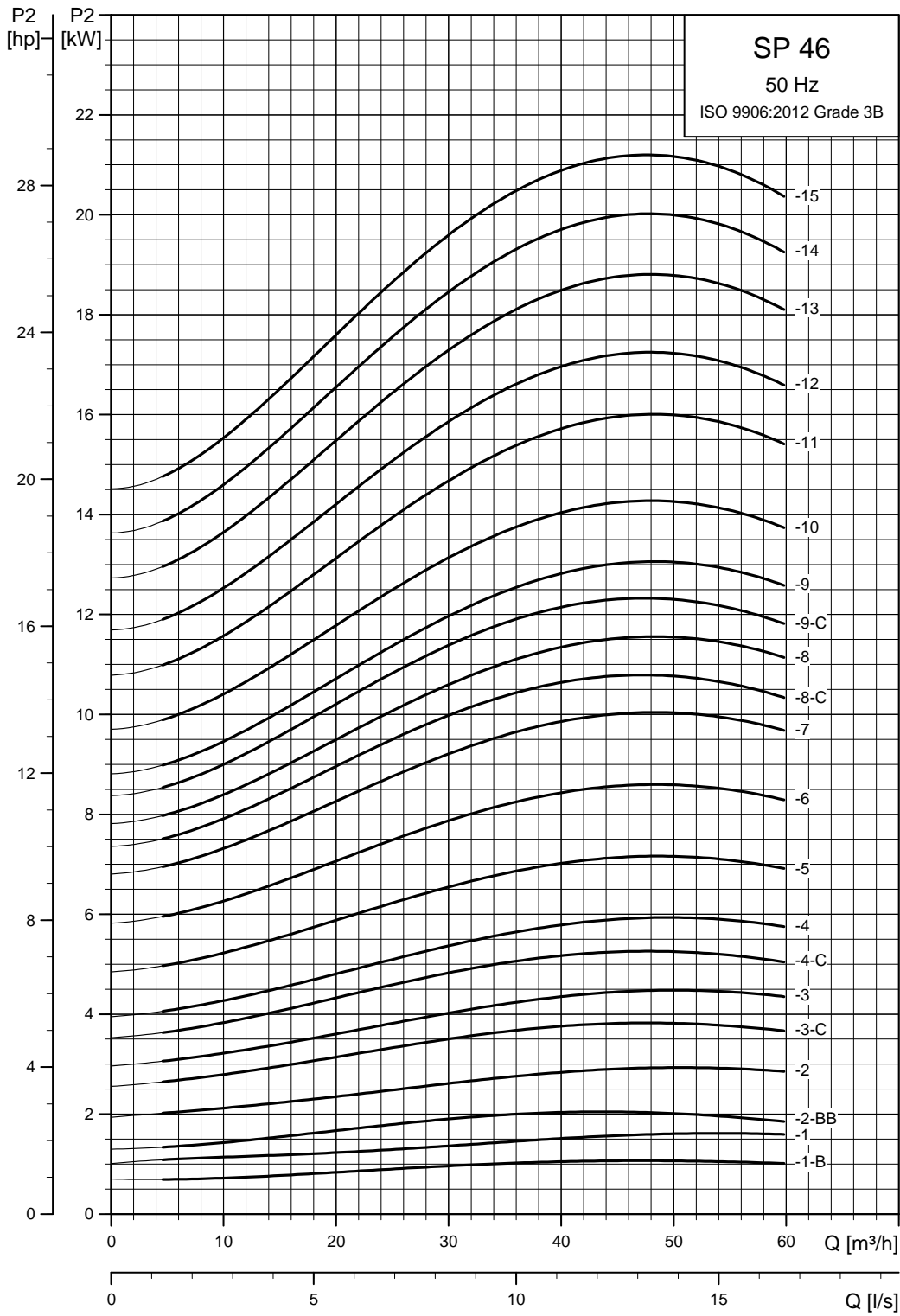

TM01 8767 4702

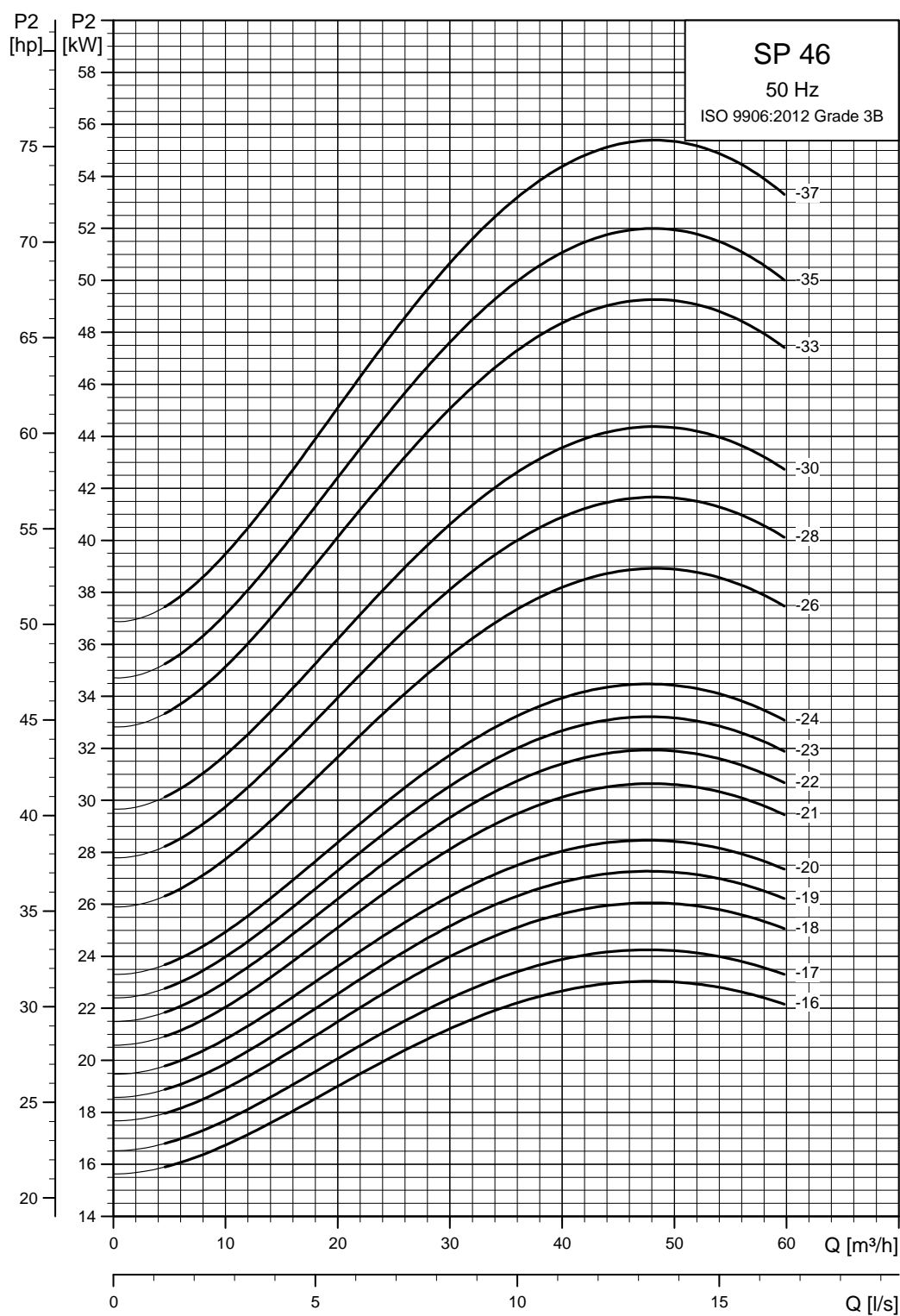

See also section [How to read the curve charts](#) on page 23.

TM01 8768 4702

SP 60

Performance curves

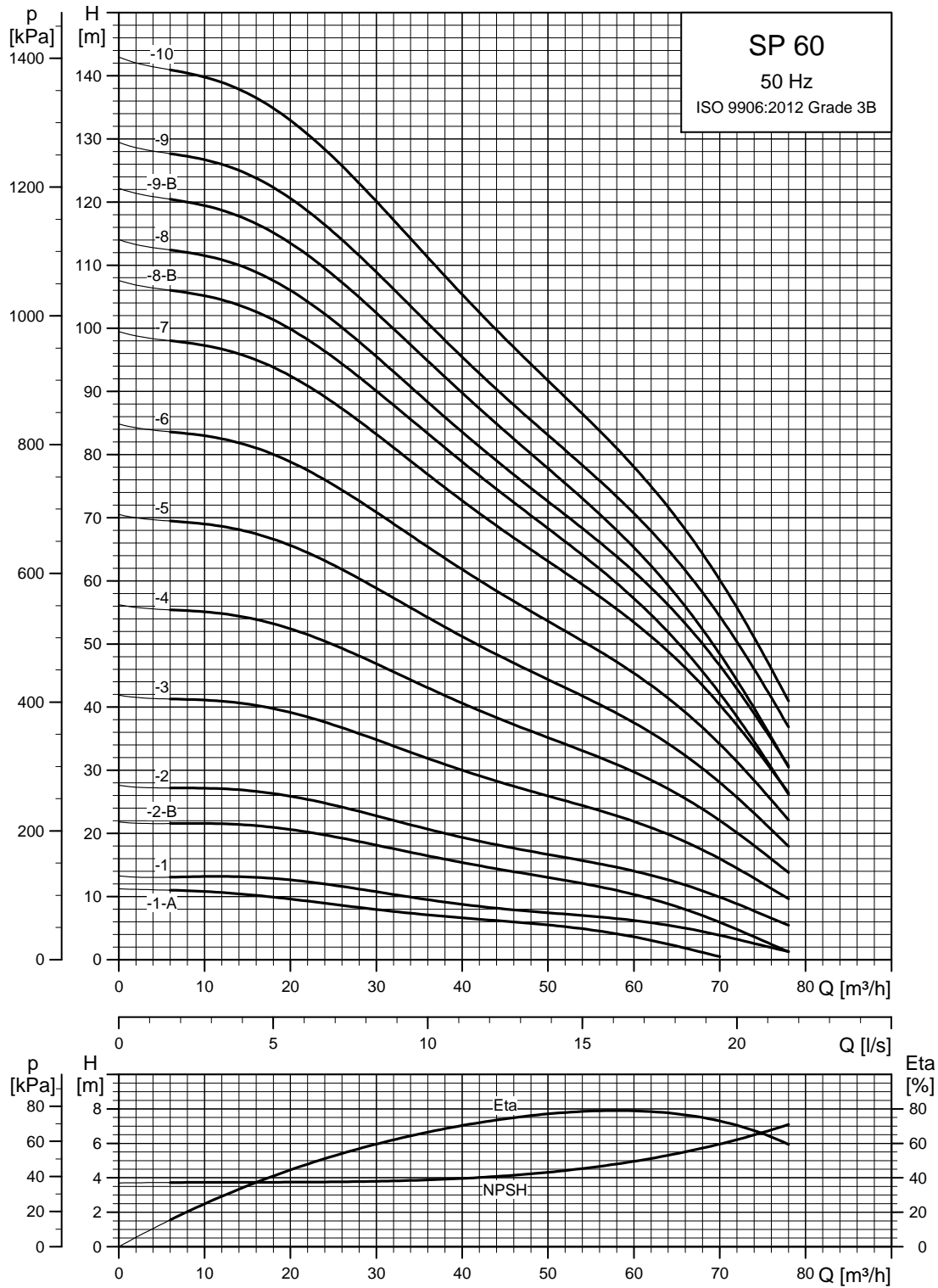

See also section [How to read the curve charts](#) on page 23.

TM01 8826 4702

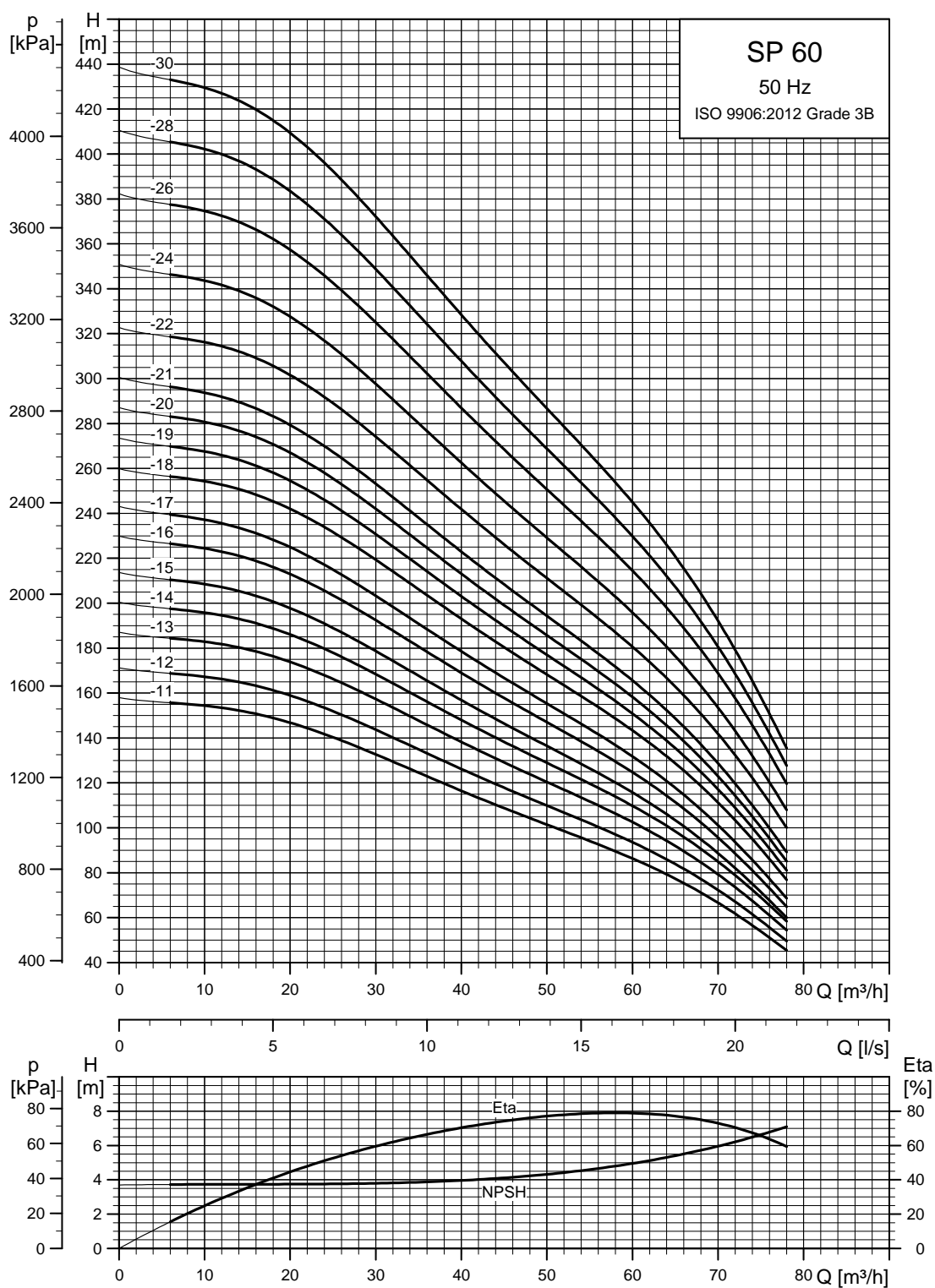

See also section [How to read the curve charts](#) on page 23.

TM01 8827 4702

Dimensions and weights

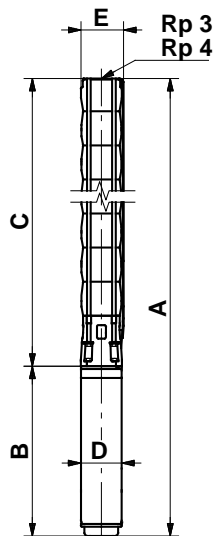

SP 60-24 to SP 60-30 are mounted in sleeve for R4 connection

TM00 0961 1196

Pump type	Motor		Dimensions [mm]					Net weight [kg]	
	Type	Power [kW]	Rp 3/Rp 4 connection						
			A	C	E*	E**	B		D
Three-phase, 3 x 230 V / 3 x 400 V									
SP 60-1-A	MS 4000	1.5	795	378	146		417	95	21
SP 60-1	MS 4000	2.2	835	378	146		457	95	23
SP 60-2-B	MS 4000	3.0	988	491	146		497	95	27
SP 60-2	MS 4000	4.0	1068	491	146		577	95	31
SP 60-3	MS 4000	5.5	1281	604	146		677	95	38
SP 60-4	MS 4000	7.5	1494	717	146		777	95	45
SP 60-3	MS 6000	5.5	1164	620	148	151	544	139.5	48
SP 60-4	MS 6000	7.5	1307	733	148	151	574	139.5	54
SP 60-5	MS 6000	9.2	1450	846	148	151	604	139.5	62
SP 60-6	MS 6000	11	1593	959	148	151	634	139.5	67
SP 60-7	MS 6000	13	1736	1072	148	151	664	139.5	73
SP 60-8-B	MS 6000	13	1849	1185	148	151	664	139.5	75
SP 60-8	MS 6000	15	1884	1185	148	151	699	139.5	79
SP 60-9-B	MS 6000	15	1997	1298	148	151	699	139.5	82
SP 60-9	MS 6000	18.5	2052	1298	148	151	754	139.5	87
SP 60-10	MS 6000	18.5	2165	1411	148	151	754	139.5	90
SP 60-11	MS 6000	22	2338	1524	148	151	814	139.5	98
SP 60-12	MS 6000	22	2451	1637	148	151	814	139.5	100
SP 60-13	MS 6000	26	2640	1766	148	151	874	139.5	109
SP 60-14	MS 6000	26	2753	1879	148	151	874	139.5	111
SP 60-15	MS 6000	26	2866	1992	148	151	874	139.5	114
SP 60-16	MS 6000	30	3049	2105	148	151	944	139.5	124
SP 60-17	MS 6000	30	3162	2218	148	151	944	139.5	126
SP 60-18	MMS 6	37	3643	2331	150	153	1312	144	169
SP 60-19	MMS 6	37	3756	2444	150	153	1312	144	171
SP 60-20	MMS 6	37	3869	2557	150	153	1312	144	174
SP 60-21	MMS 6	37	3982	2670	150	153	1312	144	176
SP 60-22	MMS 8000	45	4082	2812	192	192	1270	192	239
SP 60-24	MMS 8000	45	4555	3285	192	192	1270	192	272
SP 60-26	MMS 8000	55	4861	3511	192	192	1350	192	293
SP 60-28	MMS 8000	55	5087	3737	192	192	1350	192	299
SP 60-30	MMS 8000	55	5313	3963	192	192	1350	192	305

* Maximum diameter of pump with one motor cable.

** Maximum diameter of pump with two motor cables.

The pump types above are also available in N- and R-versions. See page 6.

Pumps mounted in sleeve are only available in standard and N-versions.

Other types of connection are possible by means of connecting pieces. See page 108.

Power curves

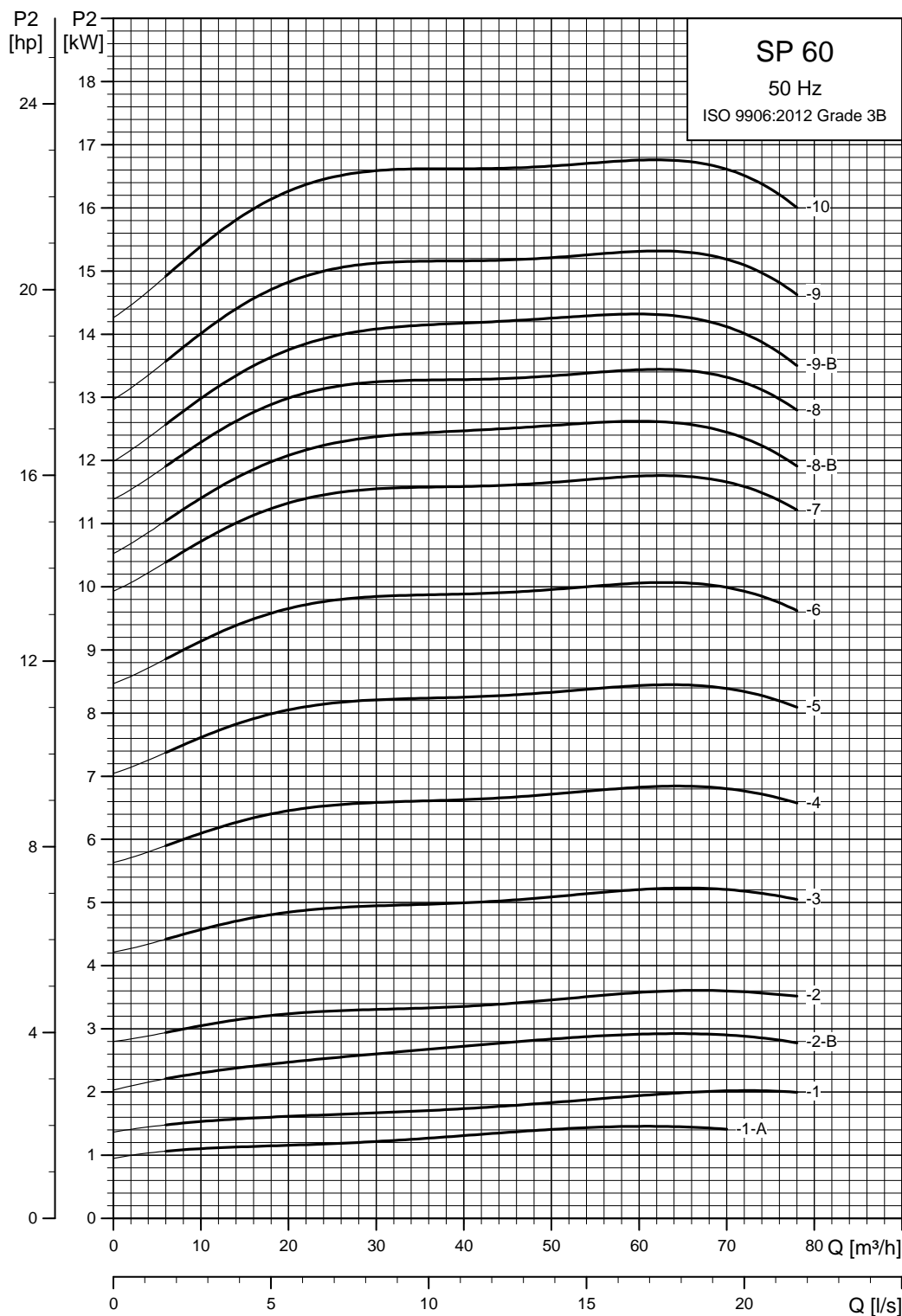

See also section [How to read the curve charts](#) on page 23.

TM01 8828 4702

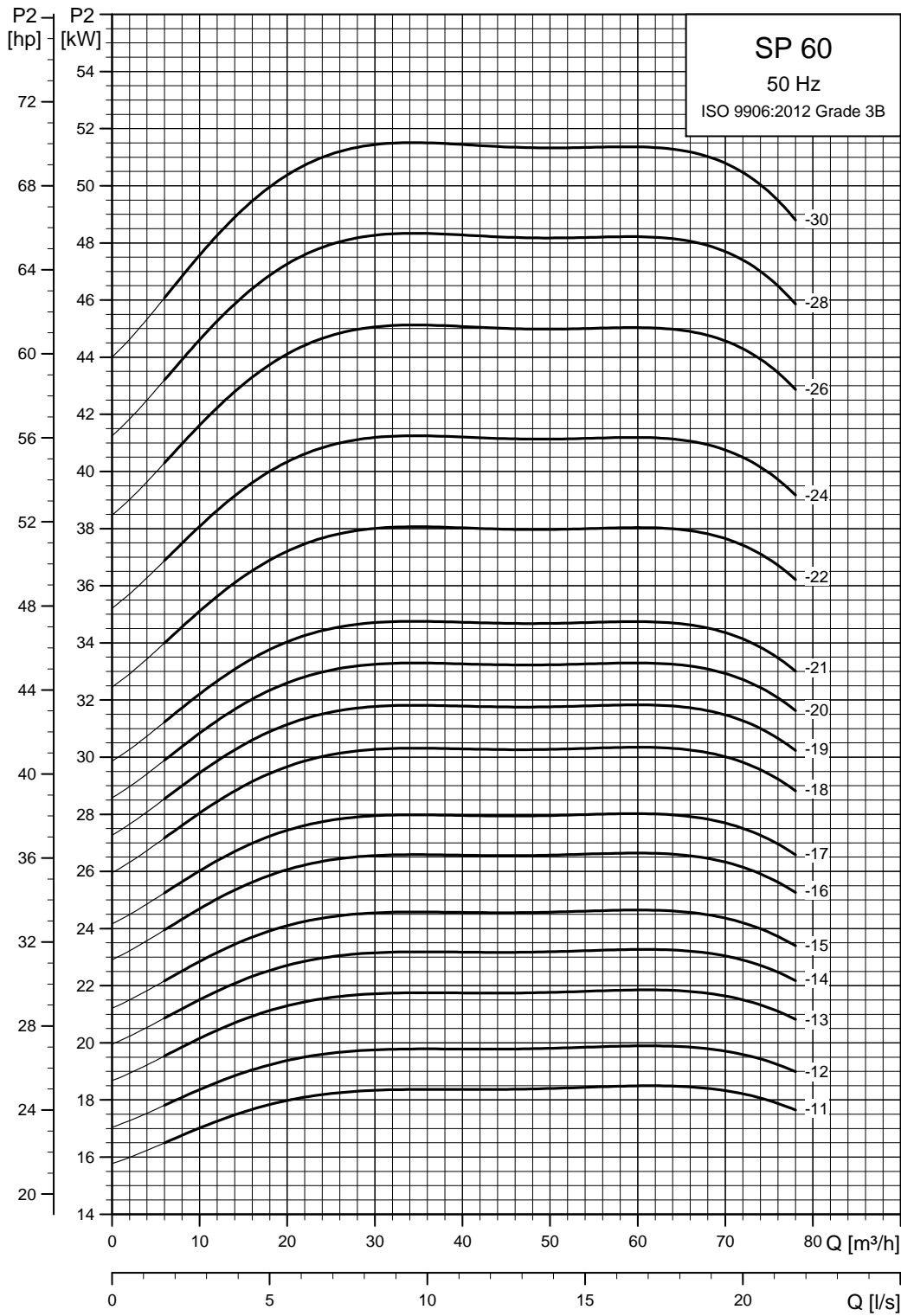

TM01 8829 4702

SP 77

Performance curves

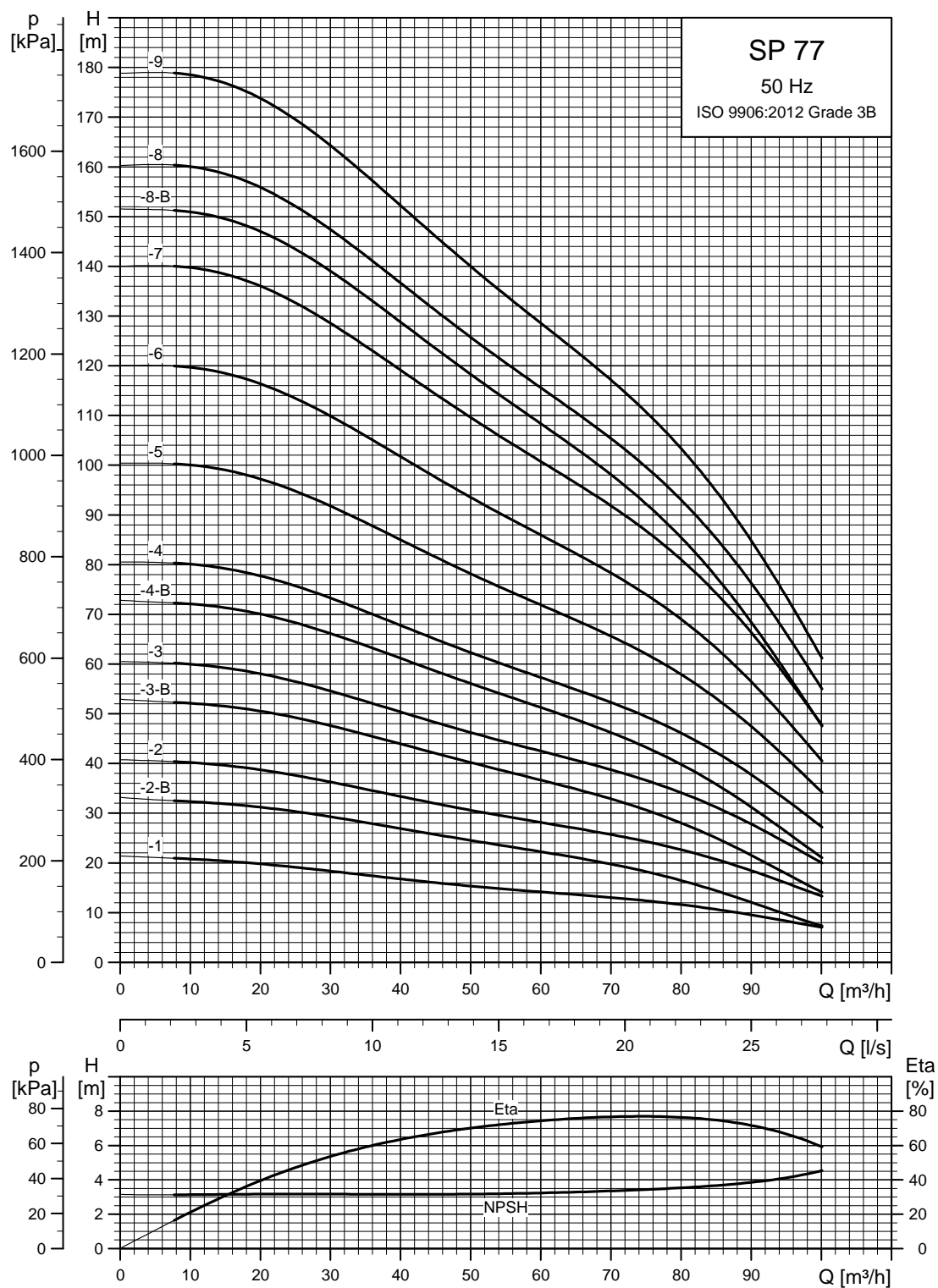

See also section [How to read the curve charts](#) on page 23.

TM01 8769 4702

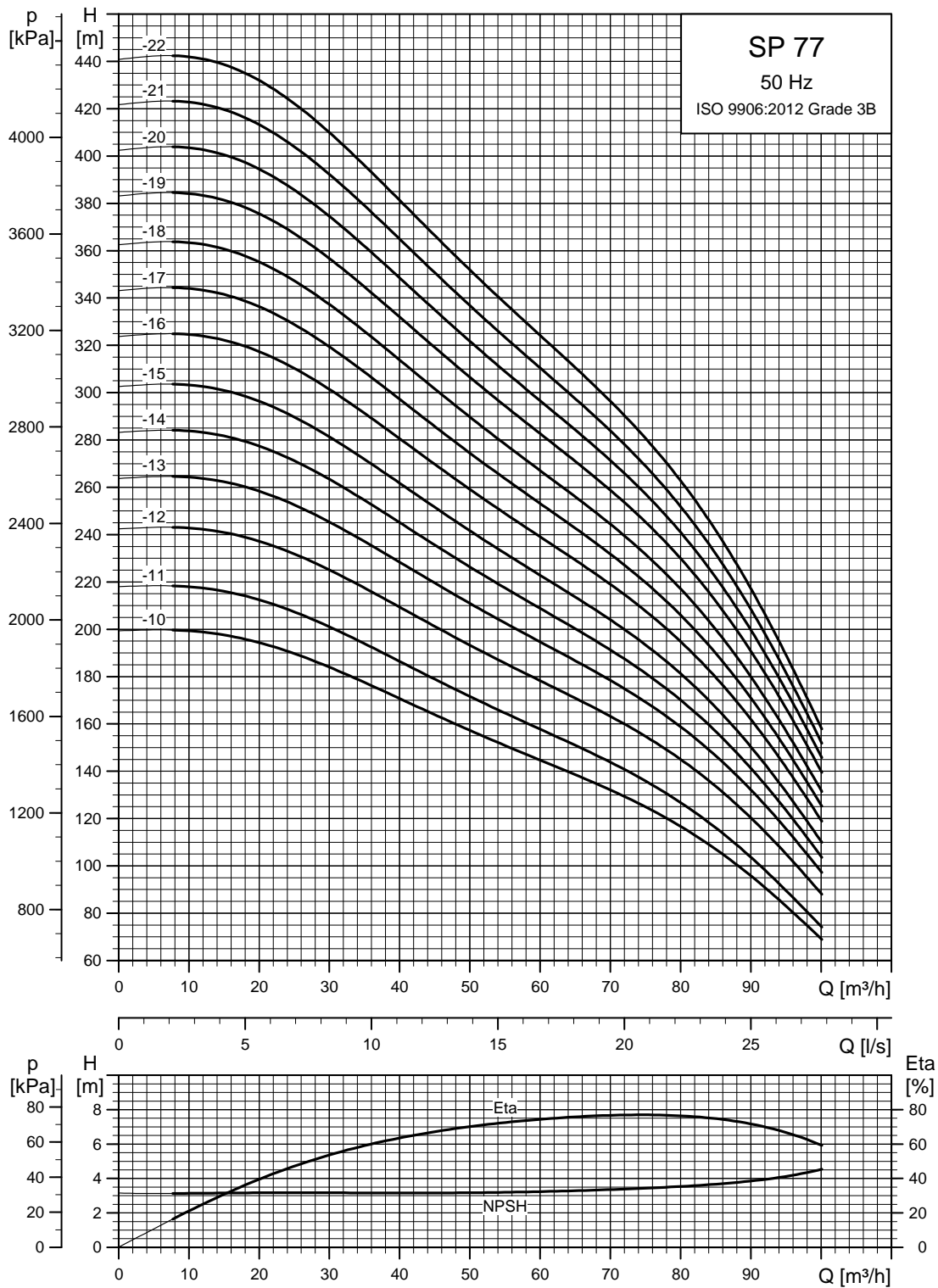

TM01 8770 4702

See also section [How to read the curve charts](#) on page 23.

Dimensions and weights

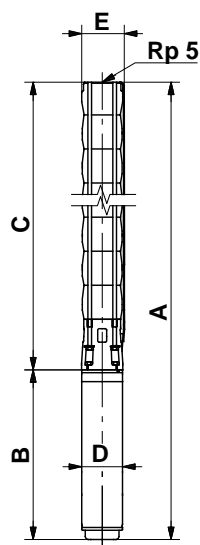

TM00 7872 2:196

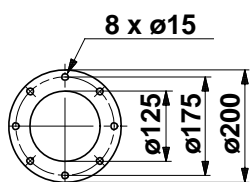

Pump with Grundfos flange

TM00 7323 1798

Pump type	Motor		Dimensions [mm]								Net weight [kg]		
	Type	Power [kW]	Rp 5 connection				5" Grundfos flange						
			A	C	E*	E**	A	C	E*	E**		B	D
Three-phase, 3 x 230 V / 3 x 400 V													
SP 77-1	MS 6000	5.5	1162	618	178	186	1162	618	200	200	544	139.5	55
SP 77-2-B	MS 6000	5.5	1290	746	178	186	1290	746	200	200	544	139.5	59
SP 77-2	MS 6000	7.5	1320	746	178	186	1320	746	200	200	574	139.5	63
SP 77-3-B	MS 6000	9.2	1478	874	178	186	1478	874	200	200	604	139.5	72
SP 77-3	MS 6000	11	1508	874	178	186	1508	874	200	200	634	139.5	75
SP 77-4-B	MS 6000	13	1667	1003	178	186	1667	1003	200	200	664	139.5	82
SP 77-4	MS 6000	15	1702	1003	178	186	1702	1003	200	200	699	139.5	86
SP 77-5	MS 6000	18.5	1885	1131	178	186	1885	1131	200	200	754	139.5	95
SP 77-6	MS 6000	22	2073	1259	178	186	2073	1259	200	200	814	139.5	105
SP 77-7	MS 6000	26	2261	1387	178	186	2261	1387	200	200	874	139.5	114
SP 77-8-B	MS 6000	26	2389	1515	178	186	2389	1515	200	200	874	139.5	118
SP 77-8	MS 6000	30	2459	1515	178	186	2459	1515	200	200	944	139.5	126
SP 77-9	MS 6000	30	2587	1643	178	186	2587	1643	200	200	944	139.5	129
SP 77-10	MMS 6	37	3083	1771	178	186	3083	1771	200	200	1312	143	176
SP 77-11	MMS 6	37	3226	1898	178	186	3210	1898	200	200	1312	143	179
SP 77-12	MMS 8000	45	3313	2043	200	204	3313	2043	209	209	1270	192	240
SP 77-13	MMS 8000	55	3522	2172	200	204	3522	2172	209	209	1350	192	259
SP 77-14	MMS 8000	55	3650	2300	200	204	3650	2300	209	209	1350	192	263
SP 77-15	MMS 8000	55	3779	2429	200	204					1350	192	266
SP 77-16	MMS 8000	63	4047	2557	200	204					1490	192	296
SP 77-17	MMS 8000	63	4175	2685	200	204					1490	192	300
SP 77-18	MMS 8000	63	4304	2814	200	204					1490	192	304
SP 77-19	MMS 8000	75	4826	3236	200	204					1590	192	334
SP 77-20	MMS 8000	75	4954	3364	200	204					1590	192	338
SP 77-21	MMS 8000	75	5082	3492	200	202					1590	192	342
SP 77-22	MMS 8000	92	5450	3620	200	202					1830	192	391

* Maximum diameter of pump with one motor cable.

** Maximum diameter of pump with two motor cables.

The pump types above are also available in N- and R-versions. See page 6.

Other types of connection are possible by means of connecting pieces. See page 108.

Power curves

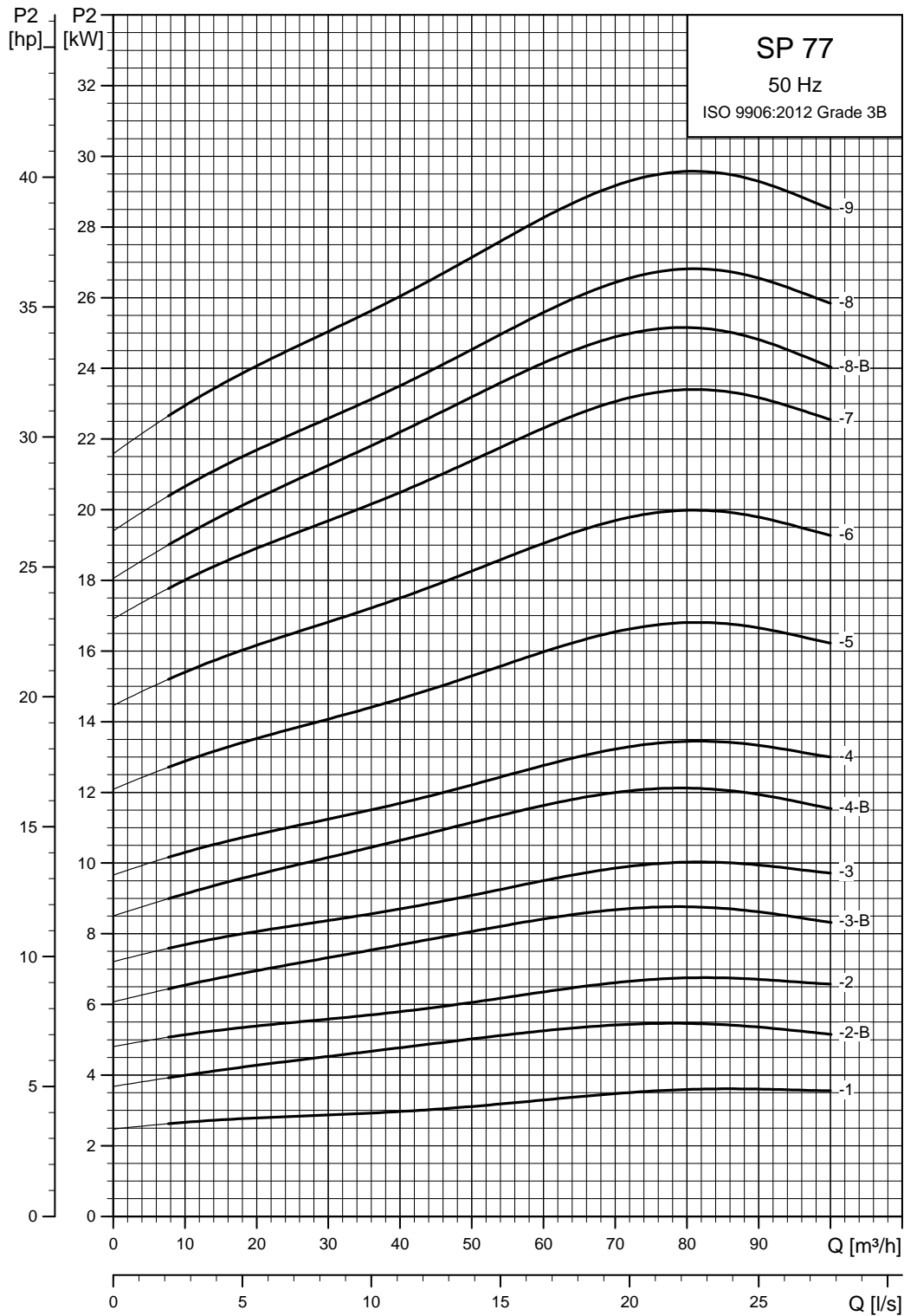

See also section [How to read the curve charts](#) on page 23.

TM01 8771 4702

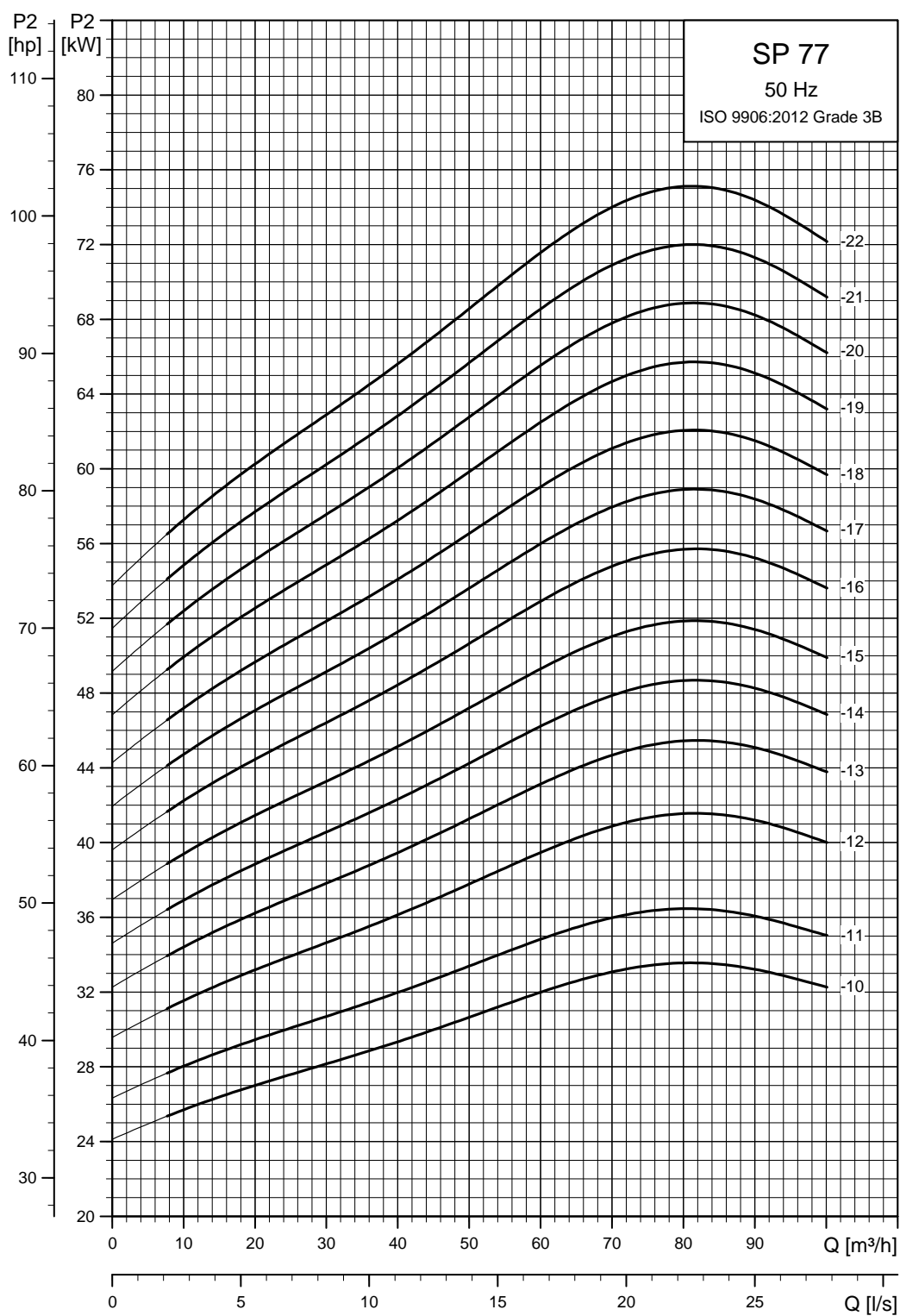

TM01 8772 4702

See also section [How to read the curve charts](#) on page 23.

SP 95

Performance curves

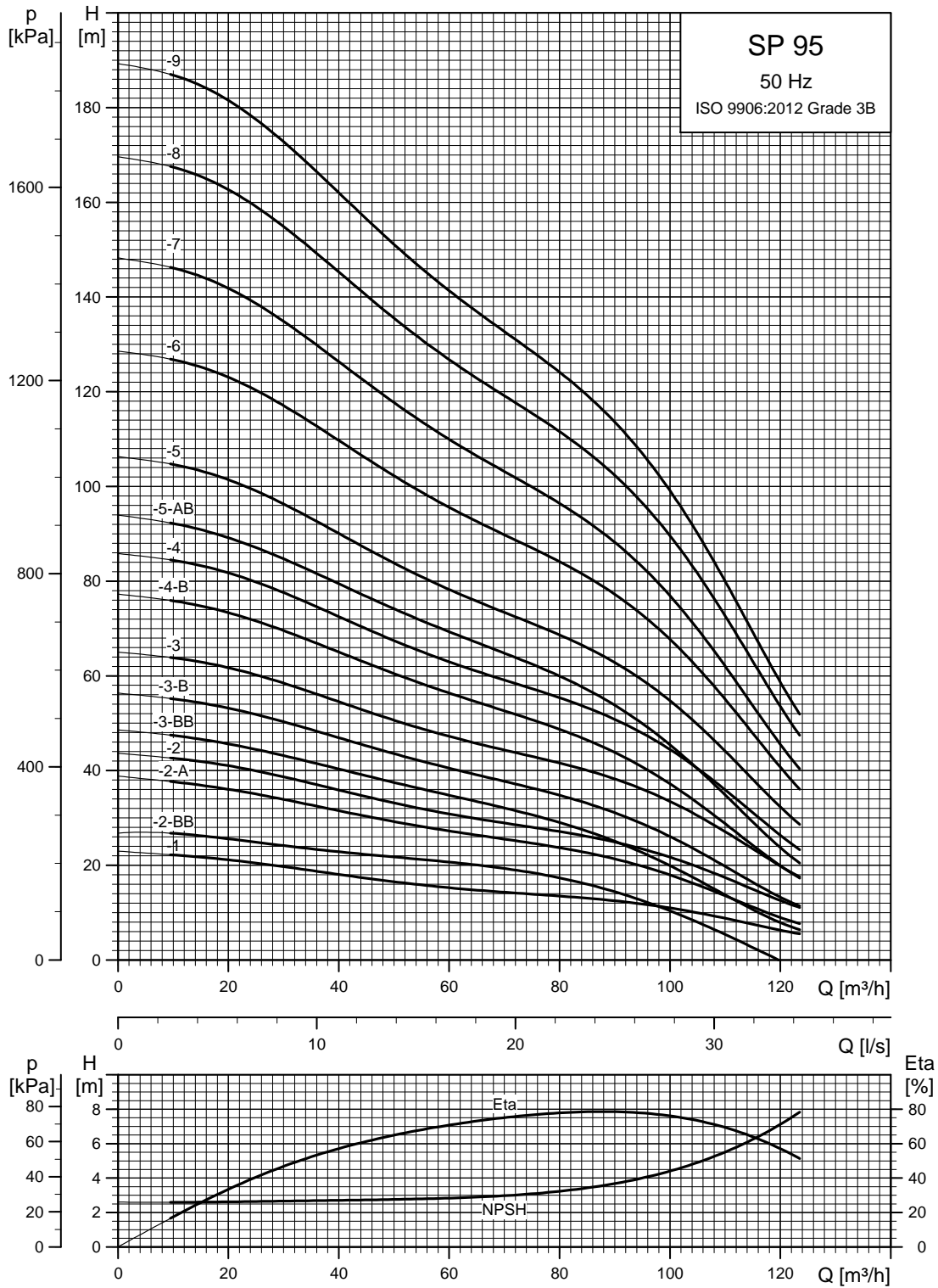

See also section [How to read the curve charts](#) on page 23.

TM01 8773 4702

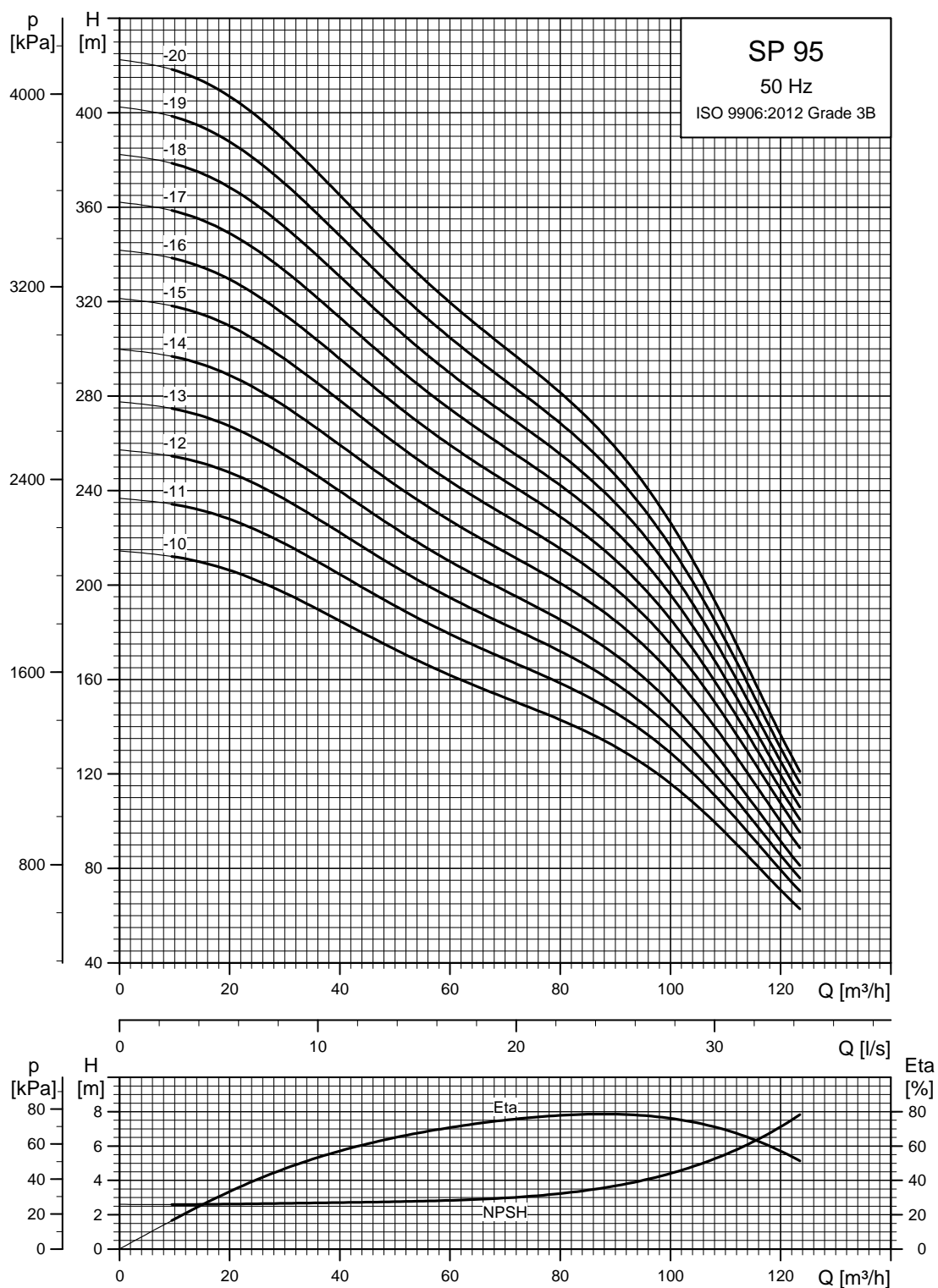

See also section [How to read the curve charts](#) on page 23.

TM01 8774 4702

Dimensions and weights

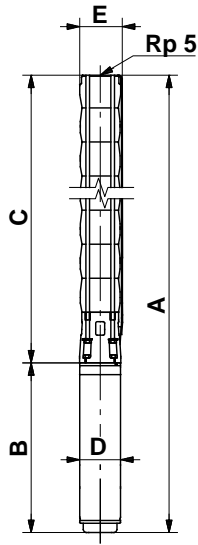

TM00 7872 2196

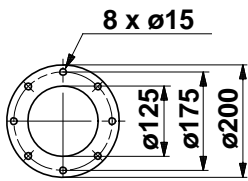

TM00 7323 1798

Pump with Grundfos flange

Pump type	Motor		Dimensions [mm]								Net weight [kg]		
	Type	Power [kW]	Rp 5 connection				5" Grundfos flange						
			A	C	E*	E**	A	C	E*	E**		B	D
Three-phase, 3 x 230 V / 3 x 400 V													
SP 95-1	MS 6000	5.5	1162	618	178	186	1162	618	200	200	544	139.5	55
SP 95-2-BB	MS 6000	5.5	1290	746	178	186	1290	746	200	200	544	139.5	72
SP 95-2-A	MS 6000	7.5	1320	746	178	186	1320	746	200	200	574	139.5	63
SP 95-2	MS 6000	9.2	1350	746	178	186	1350	746	200	200	604	139.5	68
SP 95-3-BB	MS 6000	9.2	1478	874	178	186	1478	874	200	200	604	139.5	72
SP 95-3-B	MS 6000	11	1508	874	178	186	1508	874	200	200	634	139.5	75
SP 95-3	MS 6000	13	1538	874	178	186	1538	874	200	200	664	139.5	78
SP 95-4-B	MS 6000	15	1702	1003	178	186	1702	1003	200	200	699	139.5	86
SP 95-4	MS 6000	18.5	1757	1003	178	186	1757	1003	200	200	754	139.5	91
SP 95-5-AB	MS 6000	18.5	1885	1131	178	186	1885	1131	200	200	754	139.5	95
SP 95-5	MS 6000	22	1945	1131	178	186	1945	1131	200	200	814	139.5	101
SP 95-6	MS 6000	26	2133	1259	178	186	2133	1259	200	200	874	139.5	110
SP 95-7	MS 6000	30	2331	1387	178	186	2331	1387	200	200	944	139.5	122
SP 95-8	MMS 6	37	2827	1515	178	186	2827	1515	200	200	1312	143	168
SP 95-9	MMS 6	37	2954	1642	178	186	2954	1642	200	200	1312	143	172
SP 95-10	MMS 8000	45	3055	1785	196	204	3055	1785	205	205	1270	192	233
SP 95-11	MMS 8000	55	3264	1914	196	204	3264	1914	205	205	1350	192	251
SP 95-12	MMS 8000	55	3393	2043	196	204	3393	2043	205	205	1350	192	255
SP 95-13	MMS 8000	55	3522	2172	196	204	3522	2172	205	205	1350	192	259
SP 95-14	MMS 8000	63	3790	2300	196	204	3790	2300	205	205	1490	192	289
SP 95-15	MMS 8000	75	4019	2429	196	204					1590	192	311
SP 95-16	MMS 8000	75	4147	2557	196	204					1590	192	315
SP 95-17	MMS 8000	75	4275	2685	196	204					1590	192	319
SP 95-18	MMS 8000	92	4938	3108	196	204					1830	192	376
SP 95-19	MMS 8000	92	5066	3236	196	204					1830	192	380
SP 95-20	MMS 8000	92	5194	3364	196	204					1830	192	384

* Maximum diameter of pump with one motor cable.

** Maximum diameter of pump with two motor cables.

The pump types above are also available in N- and R-versions. See page 6.

Other types of connection are possible by means of connecting pieces. See page 108.

Power curves

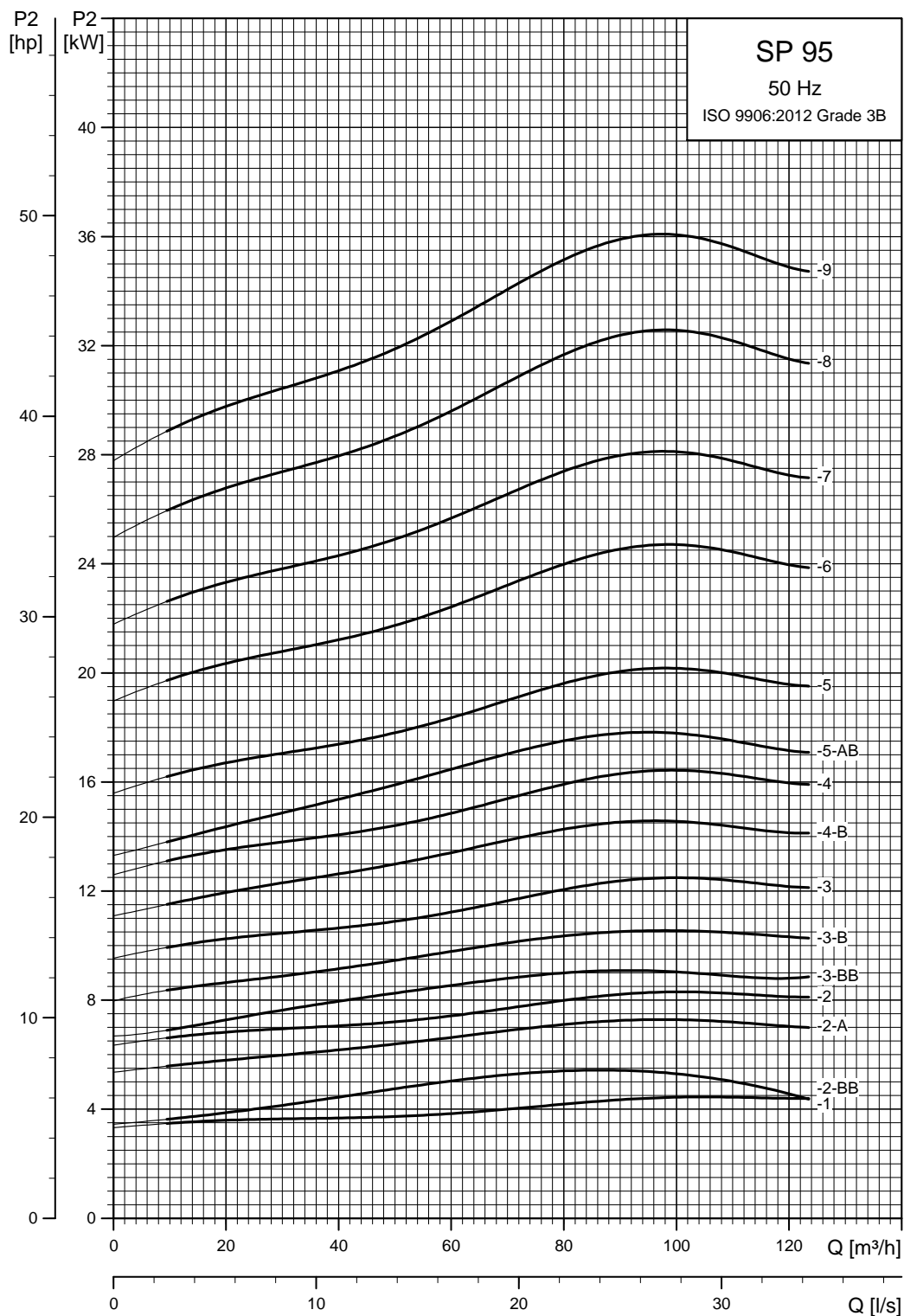

See also section [How to read the curve charts](#) on page 23.

TM01 8775 4702

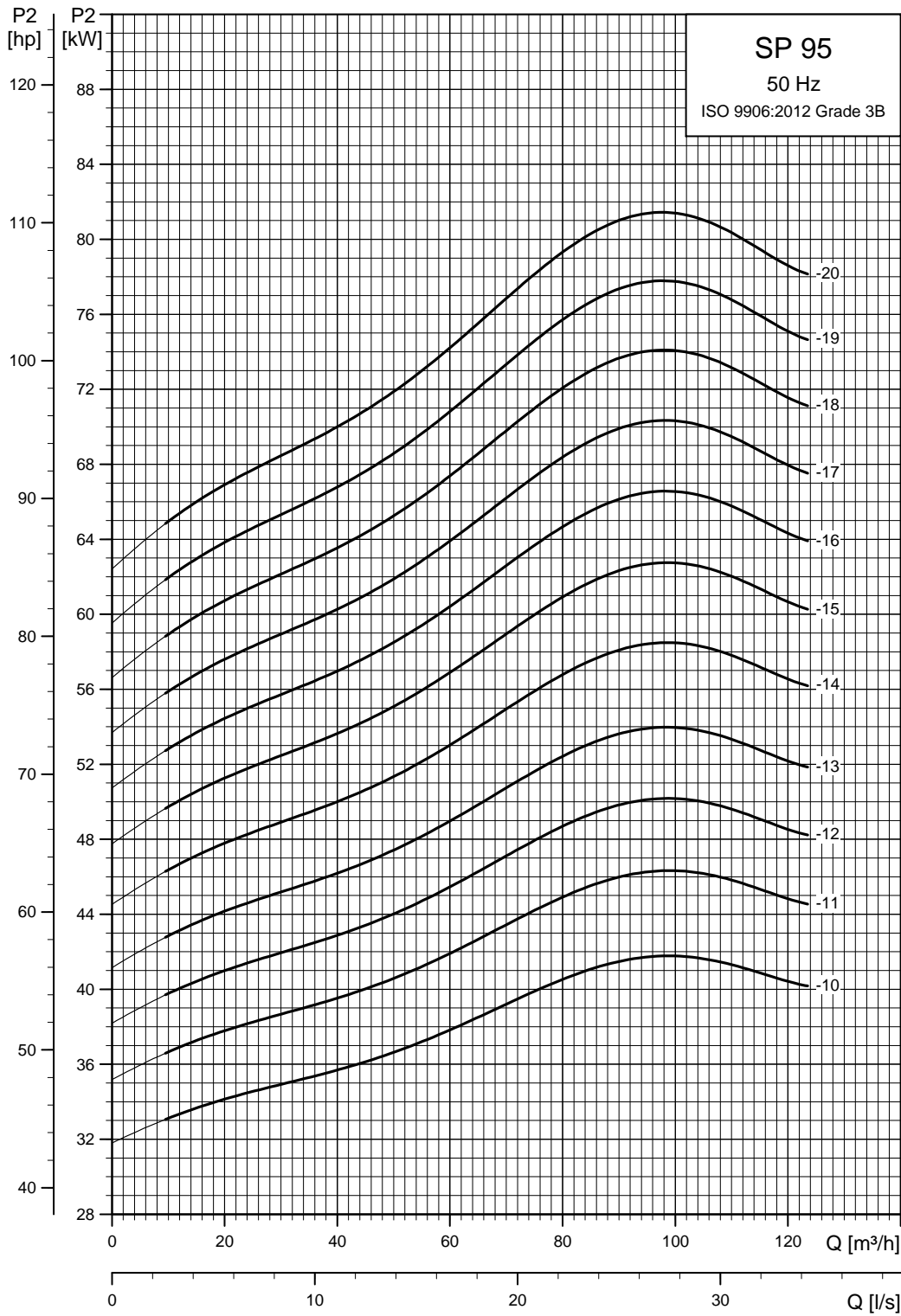

TM01 8776 4702

See also section [How to read the curve charts](#) on page 23.

SP 125

Performance curves

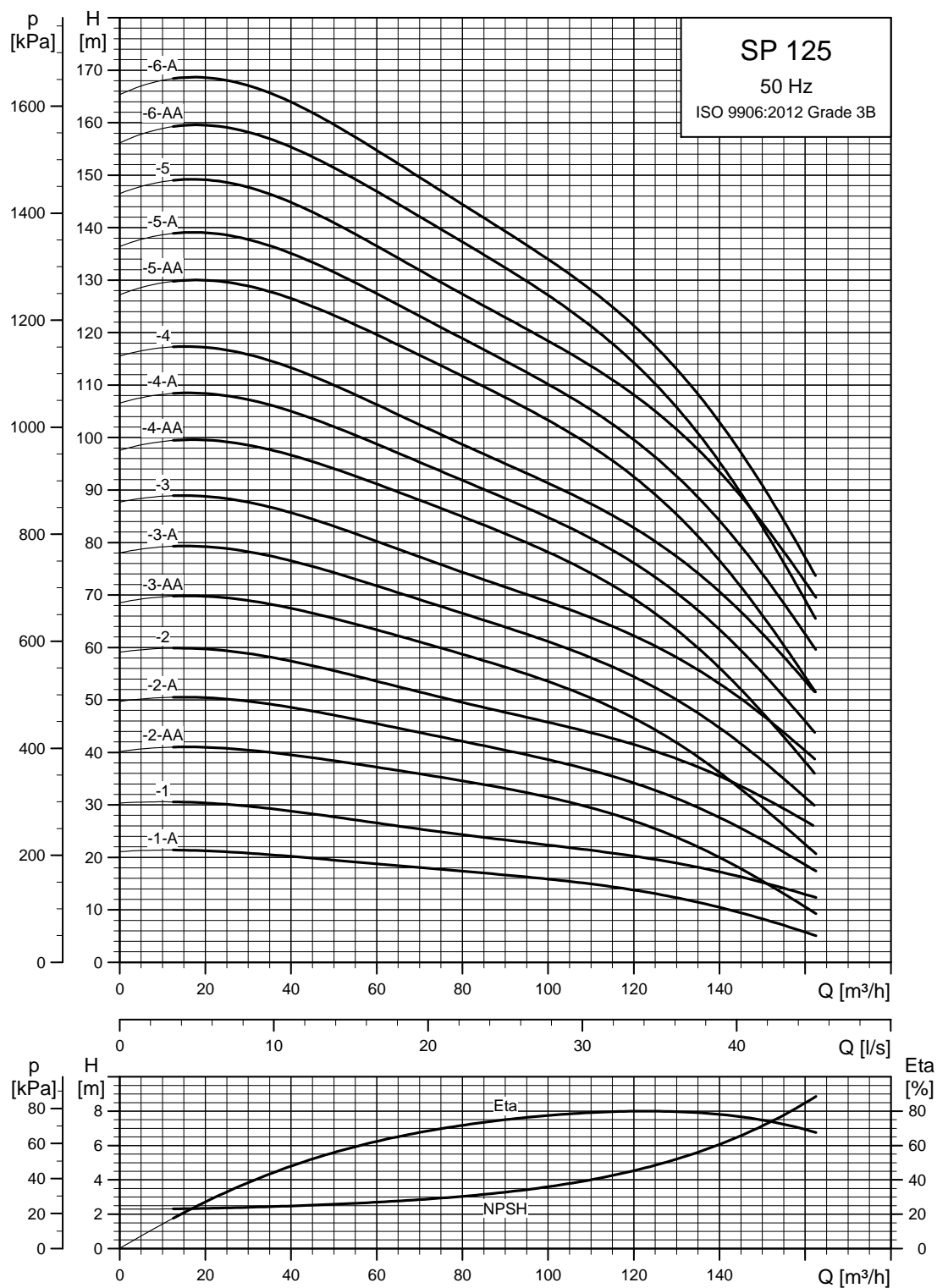

See also section [How to read the curve charts](#) on page 23.

TM01 8777 4702

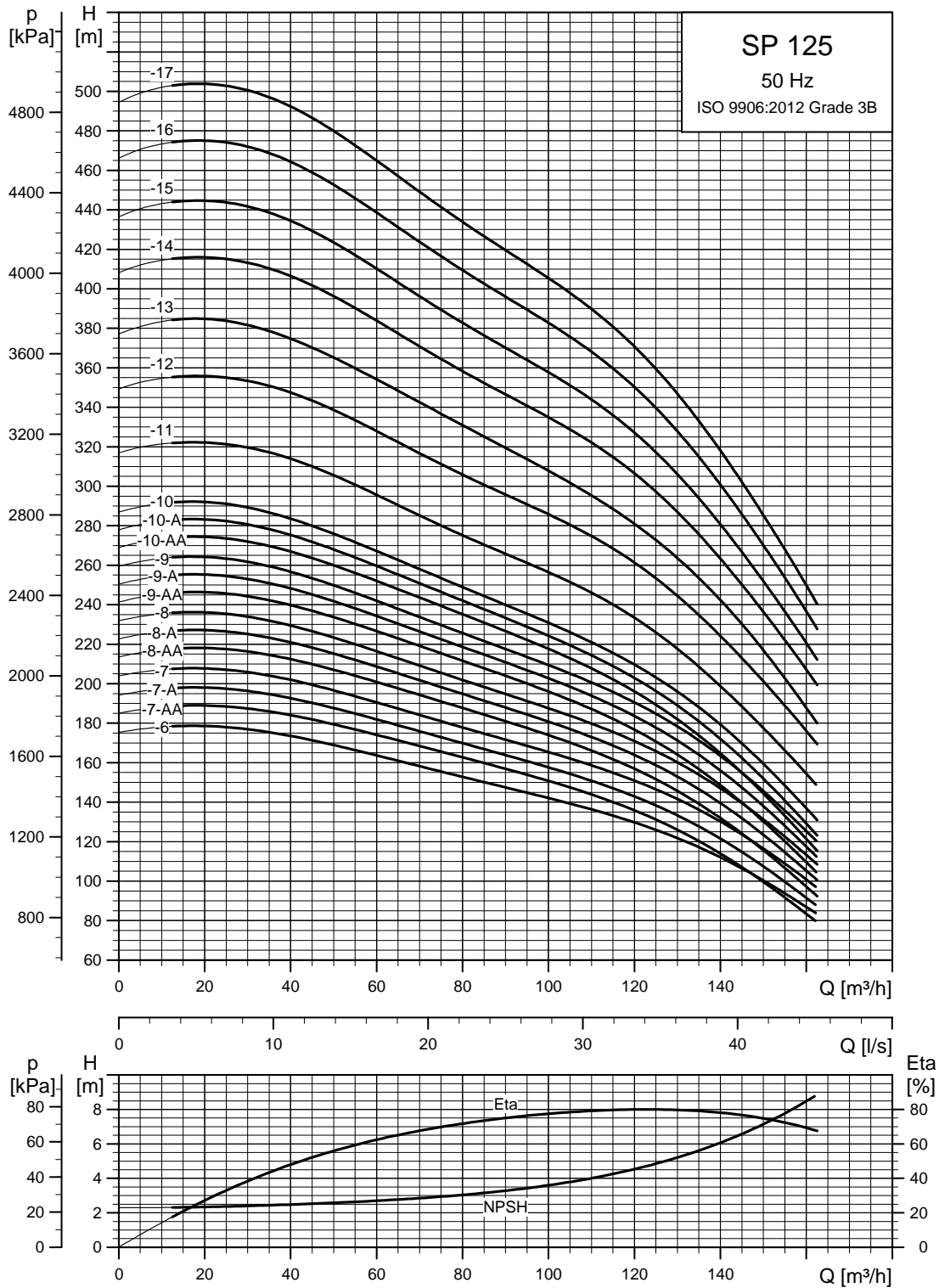

See also section [How to read the curve charts](#) on page 23.

TM01 8778 4702

Dimensions and weights

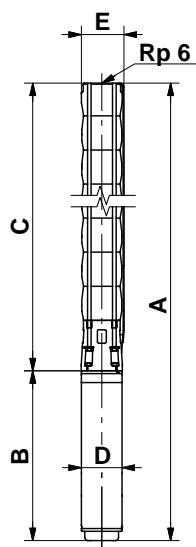

TM00 8760 3596

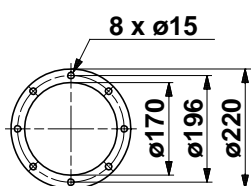

Pump with Grundfos flange

TM00 7324 1798

Pump type	Motor		Dimensions [mm]								Net weight [kg]		
	Type	Power [kW]	Rp 6 connection				6" Grundfos flange						
			A	C	E*	E**	A	C	E*	E**		B	D
Three-phase, 3 x 230 V / 3 x 400 V													
SP 125-1-A	MS 6000	7.5	1225	651	211	218	1225	651	222	226	574	139.5	70
SP 125-1	MS 6000	11	1285	651	211	218	1285	651	222	226	634	139.5	79
SP 125-2-AA	MS 6000	13	1471	807	211	218	1471	807	222	226	664	139.5	88
SP 125-2-A	MS 6000	18.5	1561	807	211	218	1561	807	222	226	754	139.5	97
SP 125-2	MS 6000	22	1621	807	211	218	1621	807	222	226	814	139.5	103
SP 125-3-AA	MS 6000	22	1777	963	211	218	1777	963	222	226	814	139.5	109
SP 125-3-A	MS 6000	26	1837	963	211	218	1837	963	222	226	874	139.5	115
SP 125-3	MS 6000	30	1907	963	211	218	1907	963	222	226	944	139.5	123
SP 125-4-AA	MMS 6	37	2431	1119	211	218	2431	1119	222	226	1312	143	171
SP 125-4-A	MMS 6	37	2431	1119	211	218	2431	1119	222	226	1312	143	171
SP 125-4	MMS 6	37	2431	1119	211	218	2431	1119	222	226	1312	143	171
SP 125-5-AA	MMS 8000	45	2545	1275	213	218	2545	1275	223	226	1270	192	236
SP 125-5-A	MMS 8000	45	2545	1275	213	218	2545	1275	223	226	1270	192	236
SP 125-5	MMS 8000	55	2625	1275	213	218	2625	1245	223	226	1350	192	251
SP 125-6-AA	MMS 8000	55	2781	1431	213	218	2781	1431	223	226	1350	192	257
SP 125-6-A	MMS 8000	55	2781	1431	213	218	2781	1431	223	226	1350	192	257
SP 125-6	MMS 8000	63	2921	1431	218	227	2921	1431	229	232	1490	192	283
SP 125-7-AA	MMS 8000	63	3077	1587	218	227	3077	1587	229	232	1490	192	289
SP 125-7-A	MMS 8000	63	3077	1587	218	227	3077	1587	229	232	1490	192	289
SP 125-7	MMS 8000	75	3177	1587	218	227	3177	1587	229	232	1590	192	308
SP 125-8-AA	MMS 8000	75	3333	1743	218	227					1590	192	314
SP 125-8-A	MMS 8000	75	3333	1743	218	227					1590	192	314
SP 125-8	MMS 8000	75	3333	1743	218	227					1590	192	314
SP 125-9-AA	MMS 8000	92	3729	1899	218	227					1830	192	366
SP 125-9-A	MMS 8000	92	3729	1899	218	227					1830	192	366
SP 125-9	MMS 8000	92	3729	1899	218	227					1830	192	366
SP 125-10-AA	MMS 8000	92	3885	2055	218	227					1830	192	372
SP 125-10-A	MMS 8000	92	3885	2055	218	227					1830	192	372
SP 125-10	MMS 8000	92	3885	2055	218	227					1830	192	372
SP 125-11	MMS 8000	110	4567	2507	218	227					2060	192	438
SP 125-12	MMS 10000	132	4584	2714	237	237					1870	237	556
SP 125-13	MMS 10000	132	4740	2870	237	237					1870	237	562
SP 125-14	MMS 10000	147	5095	3025	237	237					2070	237	633
SP 125-15	MMS 10000	147	5251	3181	237	237					2070	237	639
SP 125-16	MMS 10000	170	5556	3336	237	237					2220	237	685
SP 125-17	MMS 10000	170	5712	3492	237	237					2220	237	691

* Maximum diameter of pump with one motor cable.

** Maximum diameter of pump with two motor cables.

The pump types above are also available in N- and R-versions. See page 6.

Other types of connection are possible by means of connecting pieces. See page 108.

Power curves

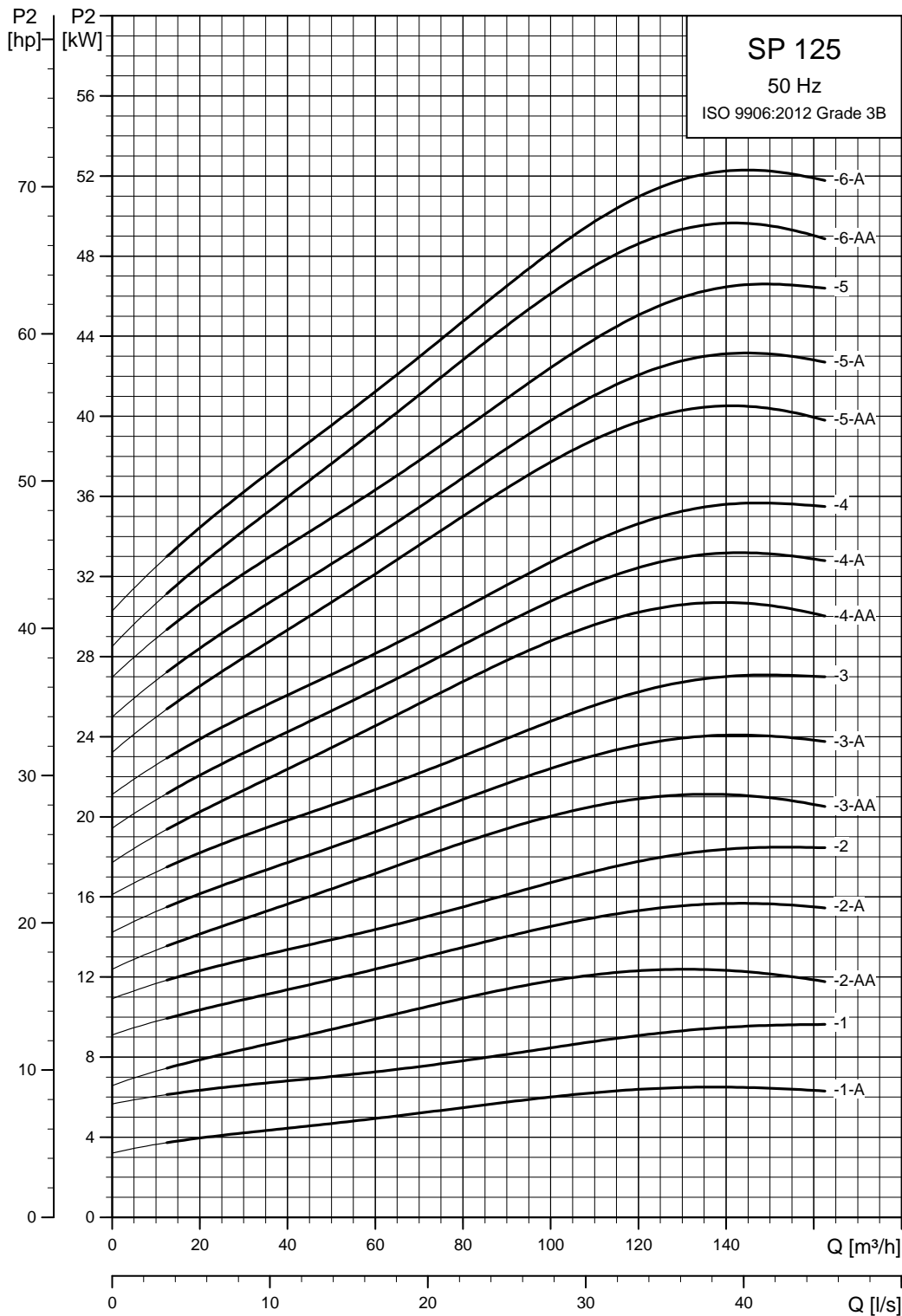

See also section [How to read the curve charts](#) on page 23.

TM01 8779 4702

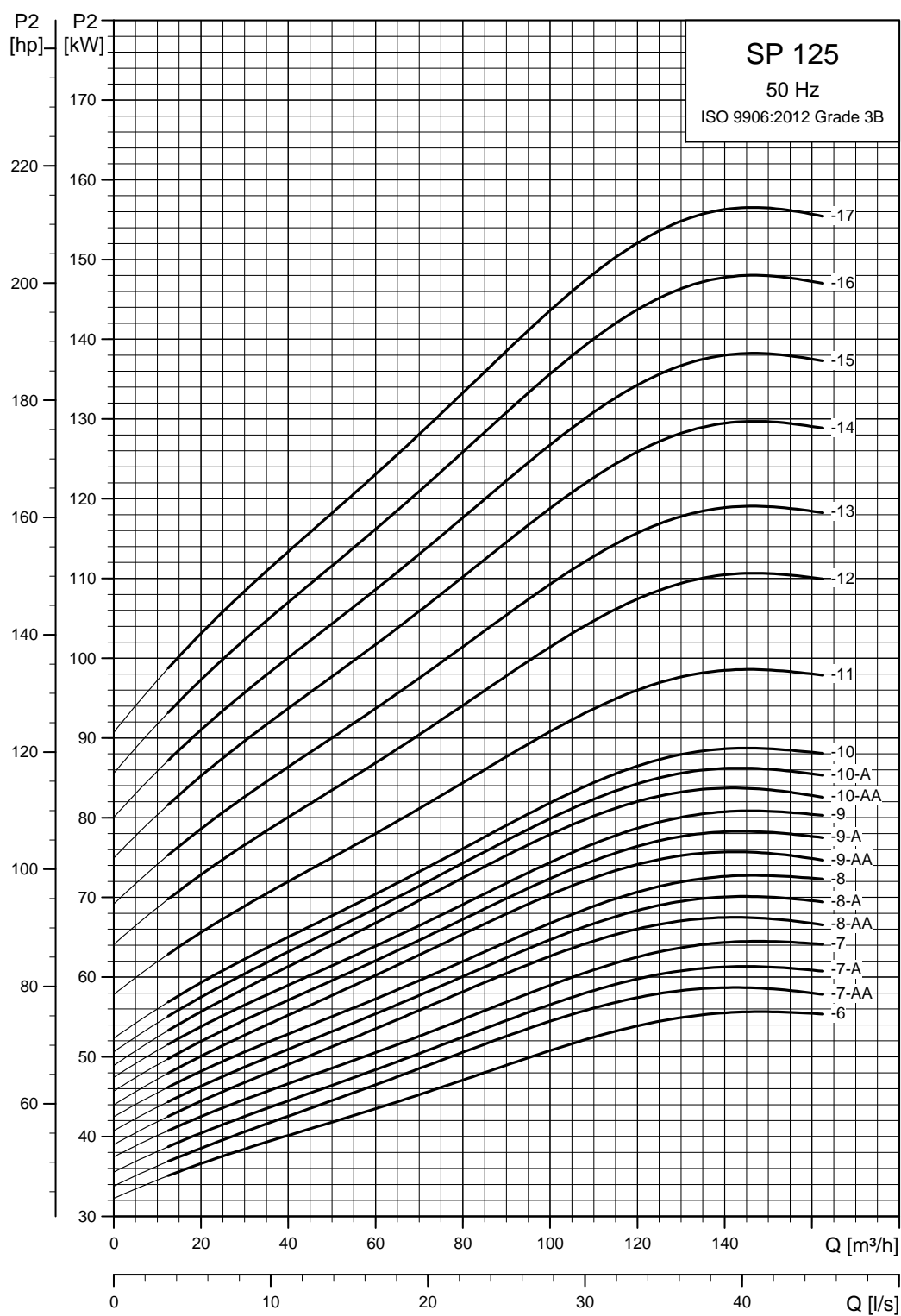

TM01 8780 4702

SP 160

Performance curves

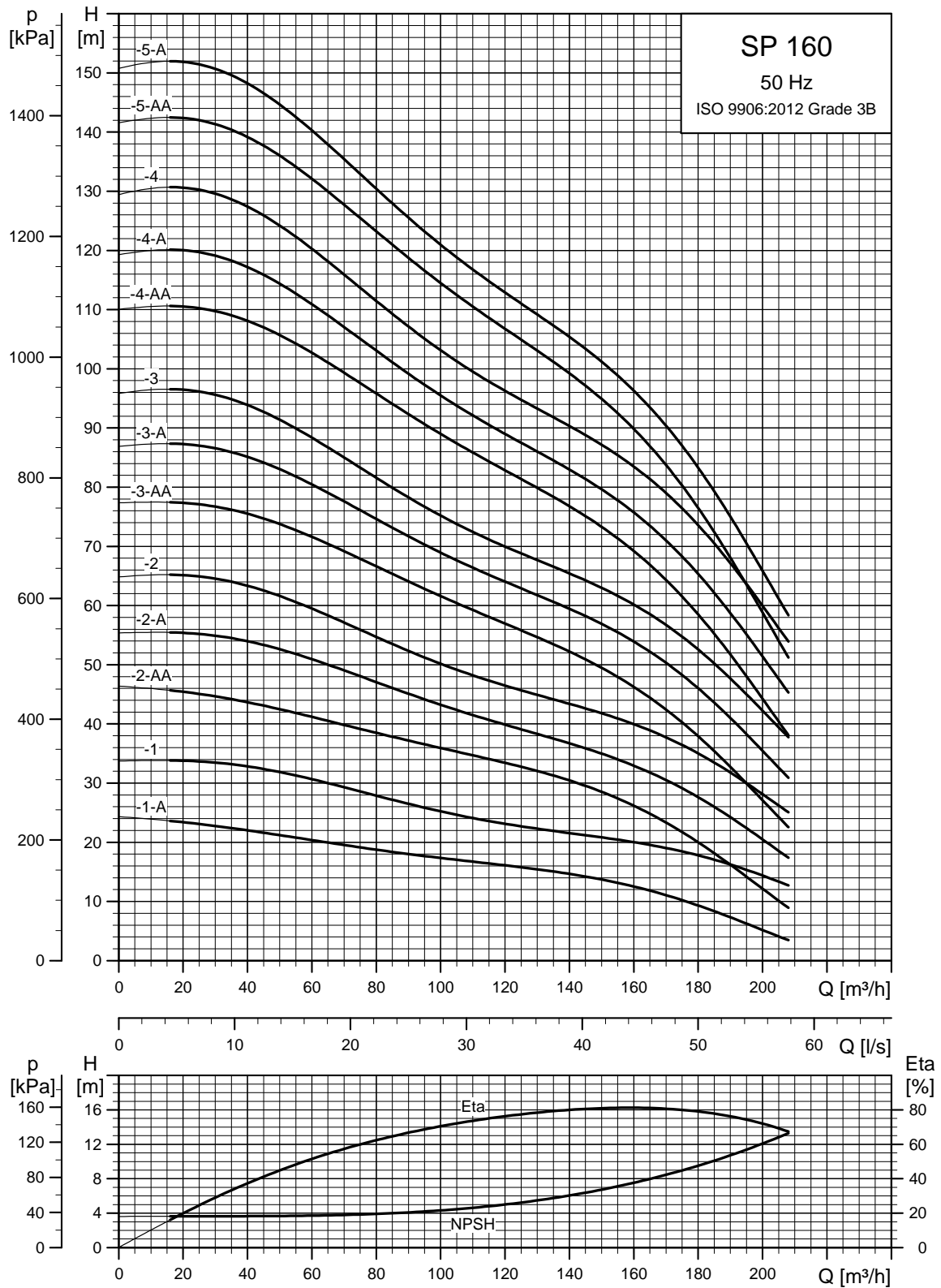

TM01 8781 4702

See also section [How to read the curve charts](#) on page 23.

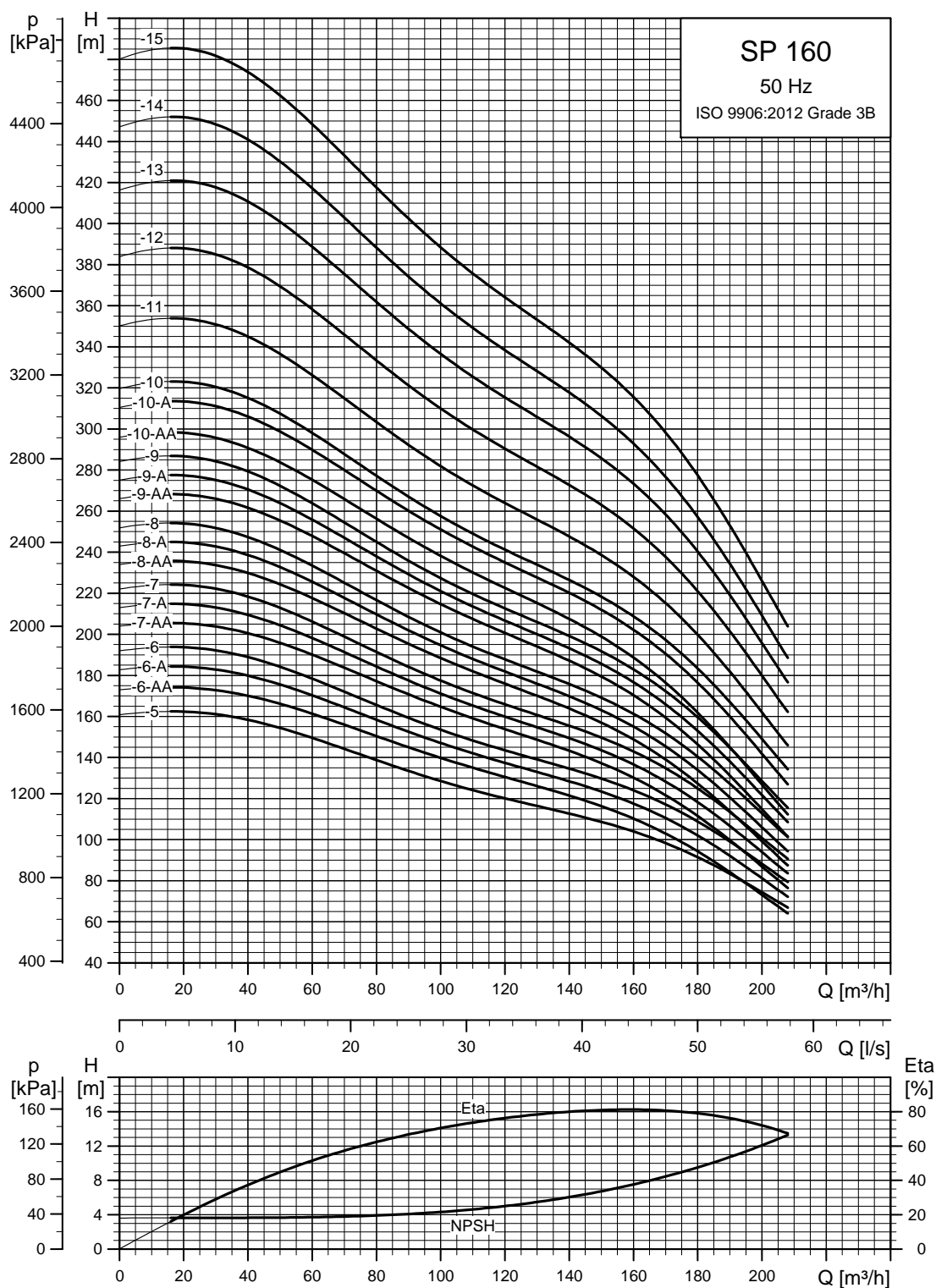

TM00 8782 4702

See also section [How to read the curve charts](#) on page 23.

Dimensions and weights

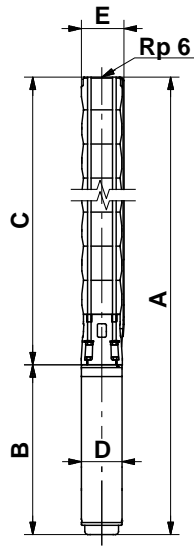

TM00 8760 3596

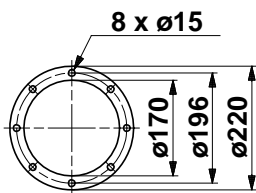

TM00 7324 1798

Pump with Grundfos flange

Pump type	Motor		Dimensions [mm]								Net weight [kg]		
	Type	Power [kW]	Rp 6 connection				6" Grundfos flange						
			A	C	E*	E**	A	C	E*	E**		B	D
Three-phase, 3 x 230 V / 3 x 400 V													
SP 160-1-A	MS 6000	9.2	1255	651	211	218	1255	651	222	226	604	139.5	76
SP 160-1	MS 6000	13	1315	651	211	218	1315	651	222	226	664	139.5	82
SP 160-2-AA	MS 6000	18.5	1561	807	211	218	1561	807	222	226	754	139.5	97
SP 160-2-A	MS 6000	22	1621	807	211	218	1621	807	222	226	814	139.5	103
SP 160-2	MS 6000	26	1681	807	211	218	1681	807	222	226	874	139.5	109
SP 160-3-AA	MS 6000	30	1907	963	211	218	1907	963	222	226	944	139.5	123
SP 160-3-A	MMS 6	37	2275	963	211	218	2275	963	222	226	1312	143	165
SP 160-3	MMS 6	37	2275	963	211	218	2275	963	222	226	1312	143	165
SP 160-4-AA	MMS 8000	45	2389	1119	218	227	2389	1119	229	232	1270	192	230
SP 160-4-A	MMS 8000	45	2389	1119	218	227	2389	1119	229	232	1270	192	230
SP 160-4	MMS 8000	55	2469	1119	218	227	2469	1119	229	232	1350	192	245
SP 160-5-AA	MMS 8000	55	2625	1275	218	227	2625	1275	229	232	1350	192	251
SP 160-5-A	MMS 8000	55	2625	1275	218	227	2625	1275	229	232	1350	192	251
SP 160-5	MMS 8000	63	2765	1275	218	227	2765	1275	229	232	1490	192	277
SP 160-6-AA	MMS 8000	63	2921	1431	218	227	2921	1431	229	232	1490	192	283
SP 160-6-A	MMS 8000	75	3021	1431	218	227	3021	1431	229	232	1590	192	302
SP 160-6	MMS 8000	75	3021	1431	218	227	3021	1431	229	232	1590	192	302
SP 160-7-AA	MMS 8000	75	3177	1587	218	227					1590	192	302
SP 160-7-A	MMS 8000	92	3417	1587	218	227					1830	192	354
SP 160-7	MMS 8000	92	3417	1587	218	227					1830	192	354
SP 160-8-AA	MMS 8000	92	3573	1743	218	227					1830	192	360
SP 160-8-A	MMS 8000	92	3573	1743	218	227					1830	192	360
SP 160-8	MMS 8000	92	3573	1743	218	227					1830	192	360
SP 160-9-AA	MMS 8000	110	3959	1899	218	227					2060	192	416
SP 160-9-A	MMS 8000	110	3959	1899	218	227					2060	192	416
SP 160-9	MMS 8000	110	3959	1899	218	227					2060	192	416
SP 160-10-AA	MMS 8000	110	4411	2351	218	227					2060	192	432
SP 160-10-A	MMS 10000	132	4273	2403	237	237					1870	237	544
SP 160-10	MMS 10000	132	4273	2403	237	237					1870	237	544
SP 160-11	MMS 10000	132	4429	2559	237	237					1870	237	550
SP 160-12	MMS 10000	147	4784	2714	237	237					2070	237	621
SP 160-13	MMS 10000	170	5090	2870	237	237					2220	237	667
SP 160-14	MMS 10000	170	5245	3025	237	237					2220	237	673
SP 160-15	MMS 12000	190	5239	3259	286	286					1980	286	803

* Maximum diameter of pump with one motor cable.

** Maximum diameter of pump with two motor cables.

The pump types above are also available in N-versions. See page 6.

SP 160-1-A to SP 160-14 are also available in R-versions. See page 6.

Other types of connection are possible by means of connecting pieces. See page 108.

Power curves

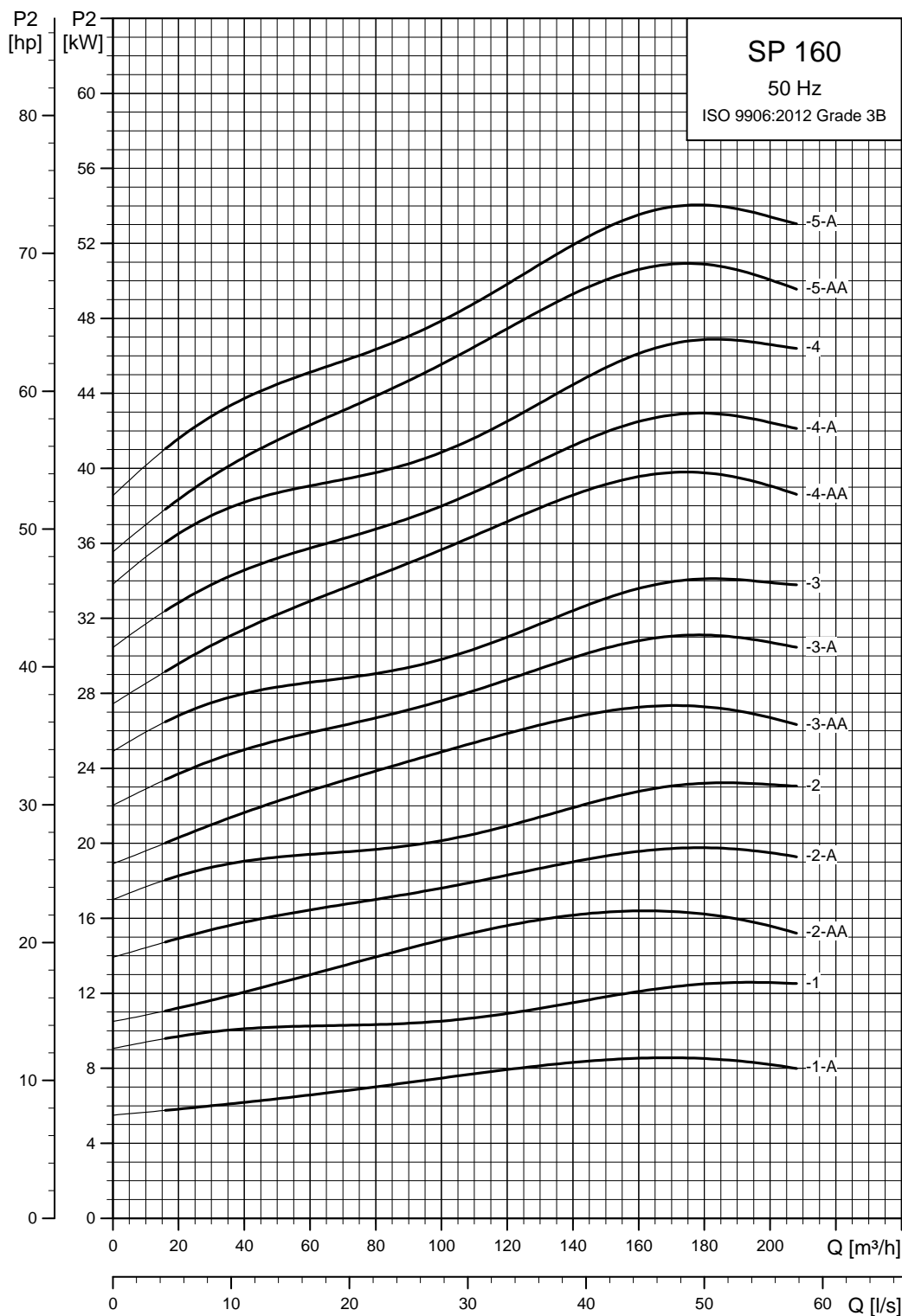

TM00 8783 4702

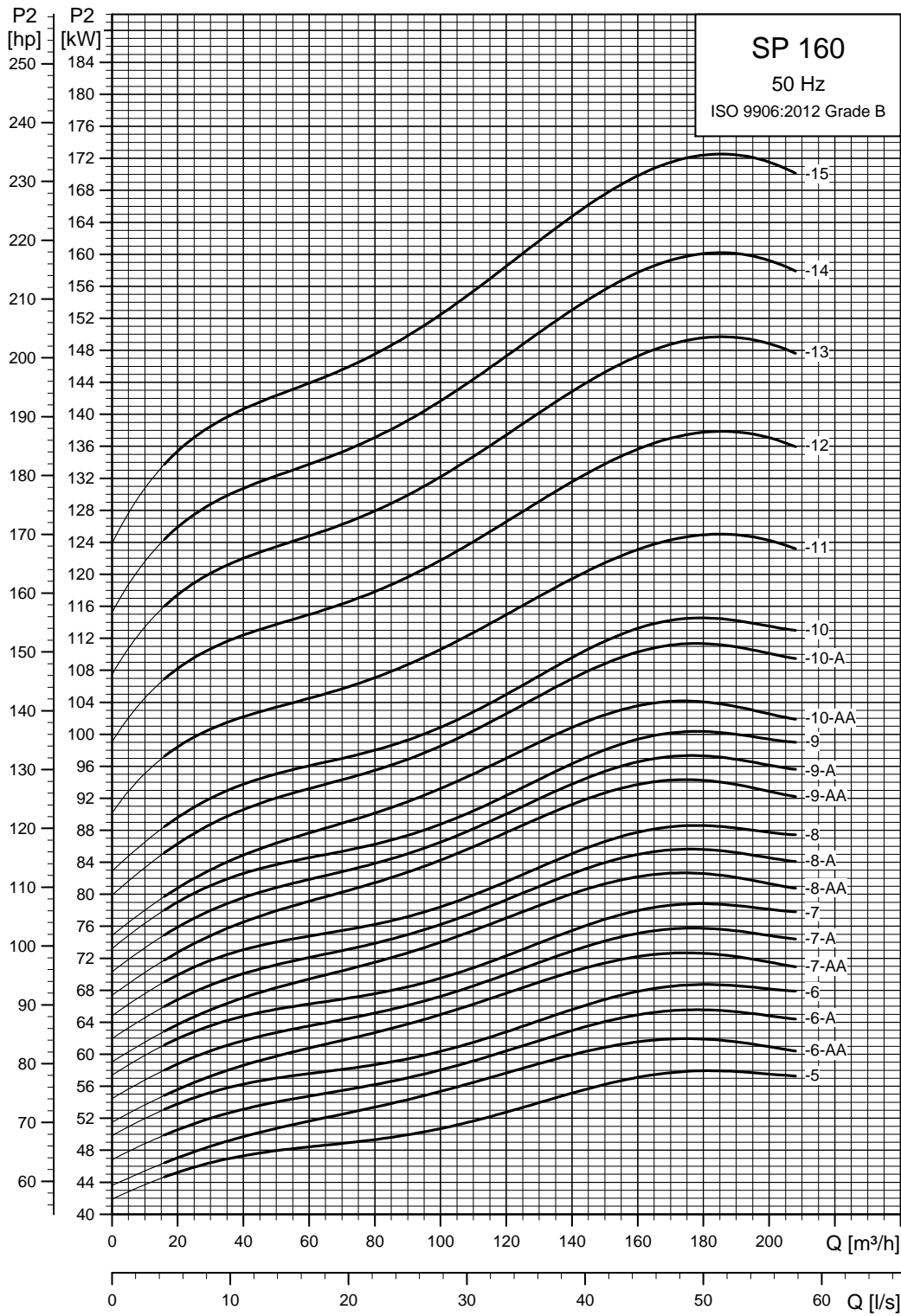

TM00 8784 4702

SP 215

Performance curves

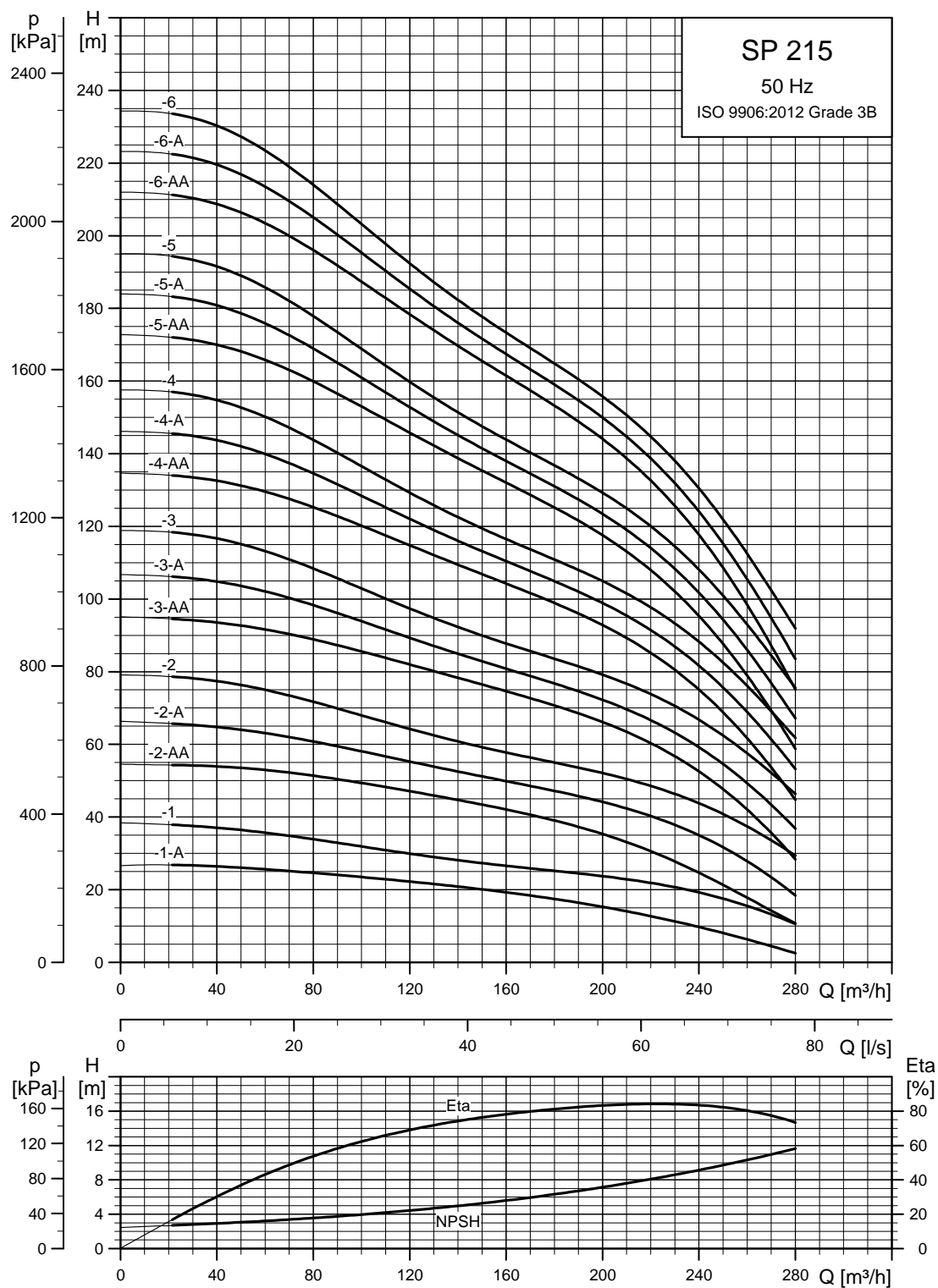

See also section [How to read the curve charts](#) on page 23.

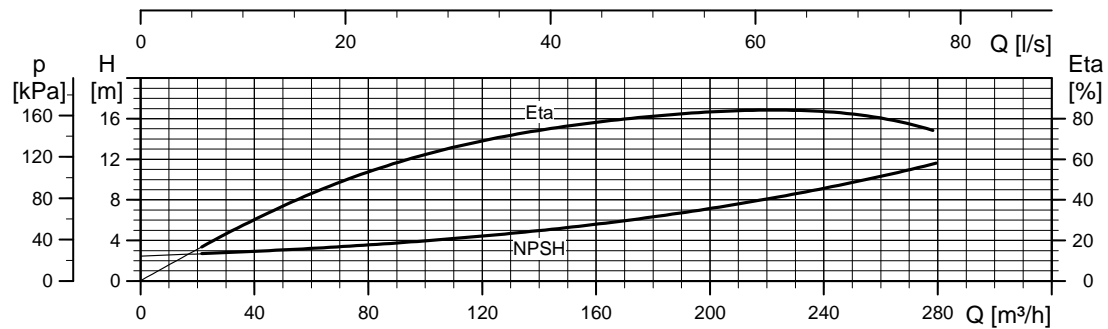
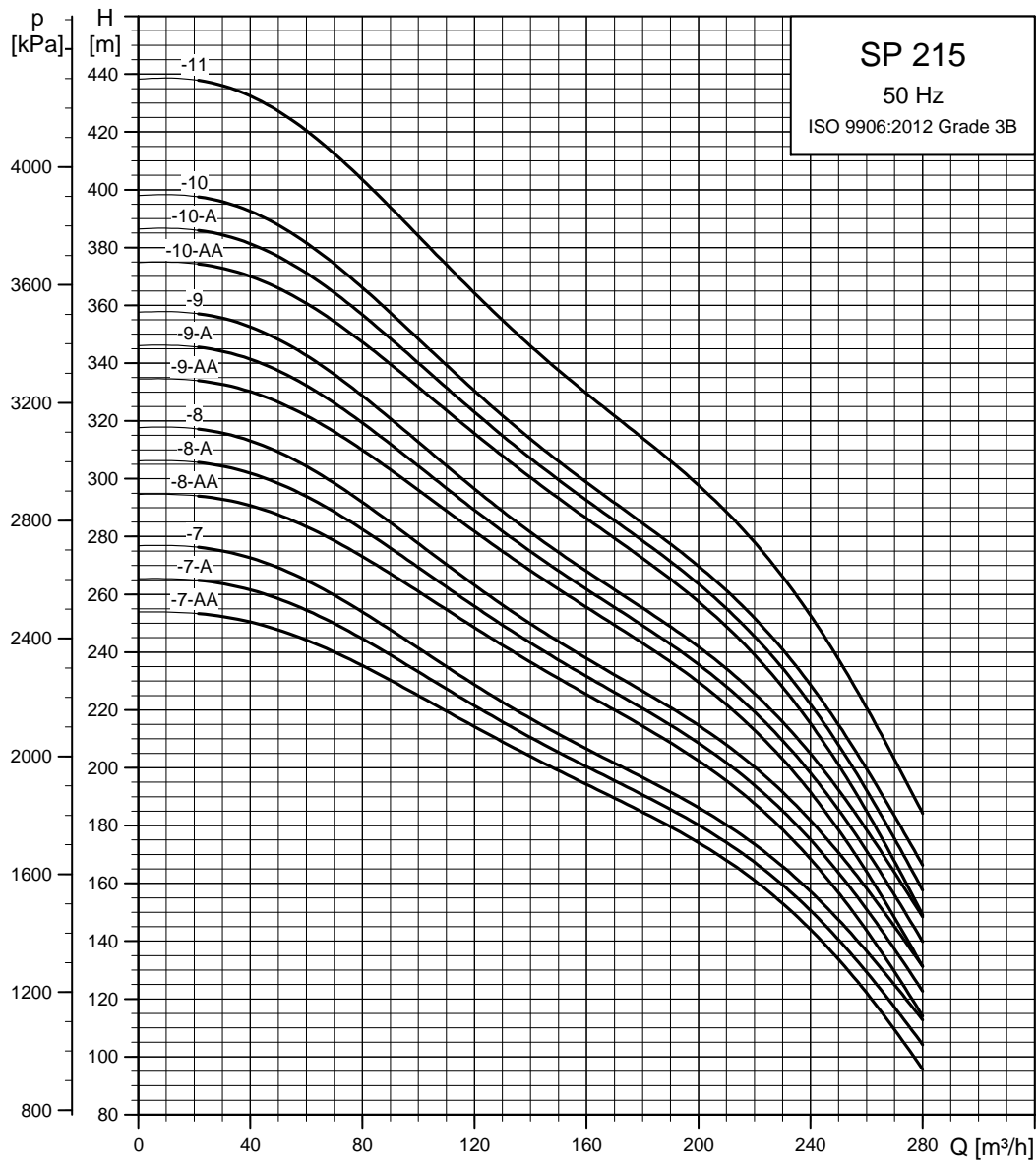

TM01 8786 4702

See also section [How to read the curve charts](#) on page 23.

Dimensions and weights

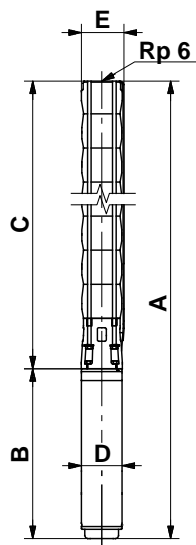

TM00 8760 3596

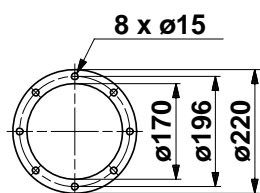

Pump with Grundfos flange

TM00 7324 1798

Pump type	Motor		Dimensions [mm]								Net weight [kg]		
	Type	Power [kW]	Rp 6 connection				6" Grundfos flange						
			A	C	E*	E**	A	C	E*	E**		B	D
Three-phase, 3 x 230 V / 3 x 400 V													
SP 215-1-A	MS 6000	15	1489	790	241	247	1489	790	241	247	699	139.5	92
SP 215-1	MS 6000	18.5	1544	790	241	247	1544	790	241	247	754	139.5	97
SP 215-2-AA	MS 6000	30	1910	966	241	247	1910	966	241	247	944	139.5	127
SP 215-2-A	MMS 6	37	2278	966	241	247	2278	966	241	247	1312	143	169
SP 215-2	MMS 8000	45	2236	966	241	247	2236	966	241	247	1270	192	228
SP 215-3-AA	MMS 8000	55	2492	1142	241	247	2492	1142	241	247	1350	192	253
SP 215-3-A	MMS 8000	55	2492	1142	241	247	2492	1142	241	247	1350	192	253
SP 215-3	MMS 8000	63	2632	1142	241	247	2632	1142	241	247	1490	192	279
SP 215-4-AA	MMS 8000	75	2908	1318	241	247	2908	1318	241	247	1590	192	308
SP 215-4-A	MMS 8000	75	2908	1318	241	247	2908	1318	241	247	1590	192	308
SP 215-4	MMS 8000	75	2908	1318	241	247	2908	1318	241	247	1590	192	308
SP 215-5-AA	MMS 8000	92	3324	1494	241	247	3324	1494	241	247	1830	192	364
SP 215-5-A	MMS 8000	92	3324	1494	241	247	3324	1494	241	247	1830	192	364
SP 215-5	MMS 8000	92	3554	1494	241	247	3554	1494	241	247	1830	192	364
SP 215-6-AA	MMS 8000	110	3730	1670	241	247	3730	1670	241	247	2060	192	424
SP 215-6-A	MMS 8000	110	3730	1670	241	247	3730	1670	241	247	2060	192	424
SP 215-6	MMS 8000	110	3730	1670	241	247	3730	1670	241	247	2060	192	424
SP 215-7-AA	MMS 10000	132	4016	2146	241	247					1870	237	547
SP 215-7-A	MMS 10000	132	4016	2146	241	247					1870	237	547
SP 215-7	MMS 10000	132	4016	2146	241	247					1870	237	547
SP 215-8-AA	MMS 10000	147	4392	2322	241	247					2070	237	622
SP 215-8-A	MMS 10000	147	4392	2322	241	247					2070	237	622
SP 215-8	MMS 10000	147	4392	2322	241	247					2070	237	622
SP 215-9-AA	MMS 10000	170	4718	2498	276	276					2220	237	672
SP 215-9-A	MMS 10000	170	4718	2498	276	276					2220	237	672
SP 215-9	MMS 10000	170	4718	2498	276	276					2220	237	672
SP 215-10-AA	MMS 12000	190	4654	2674	276	276					1980	286	793
SP 215-10-A	MMS 12000	190	4654	2674	276	276					1980	286	793
SP 215-10	MMS 12000	190	4654	2674	276	276					1980	286	793
SP 215-11	MMS 12000	220	4990	2850	286	286					2140	286	853

* Maximum diameter of pump with one motor cable.

** Maximum diameter of pump with two motor cables.

The pump types above are also available in N-versions. See page 6.

SP 215-1-A to SP 215-9 are also available in R-versions. See page 6.

Other types of connection are possible by means of connecting pieces. See page 108.

Power curves

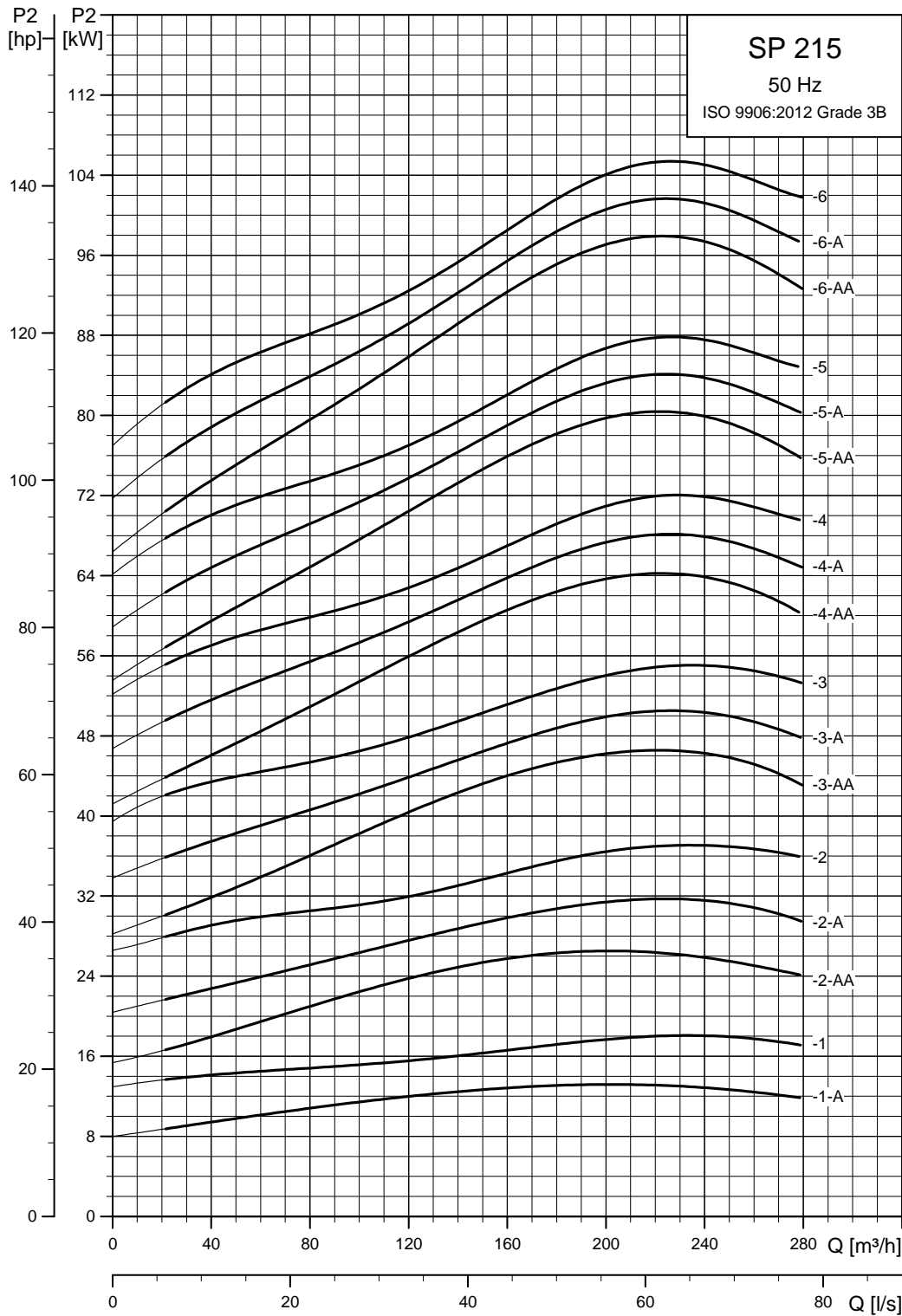

TM01 8787 4702

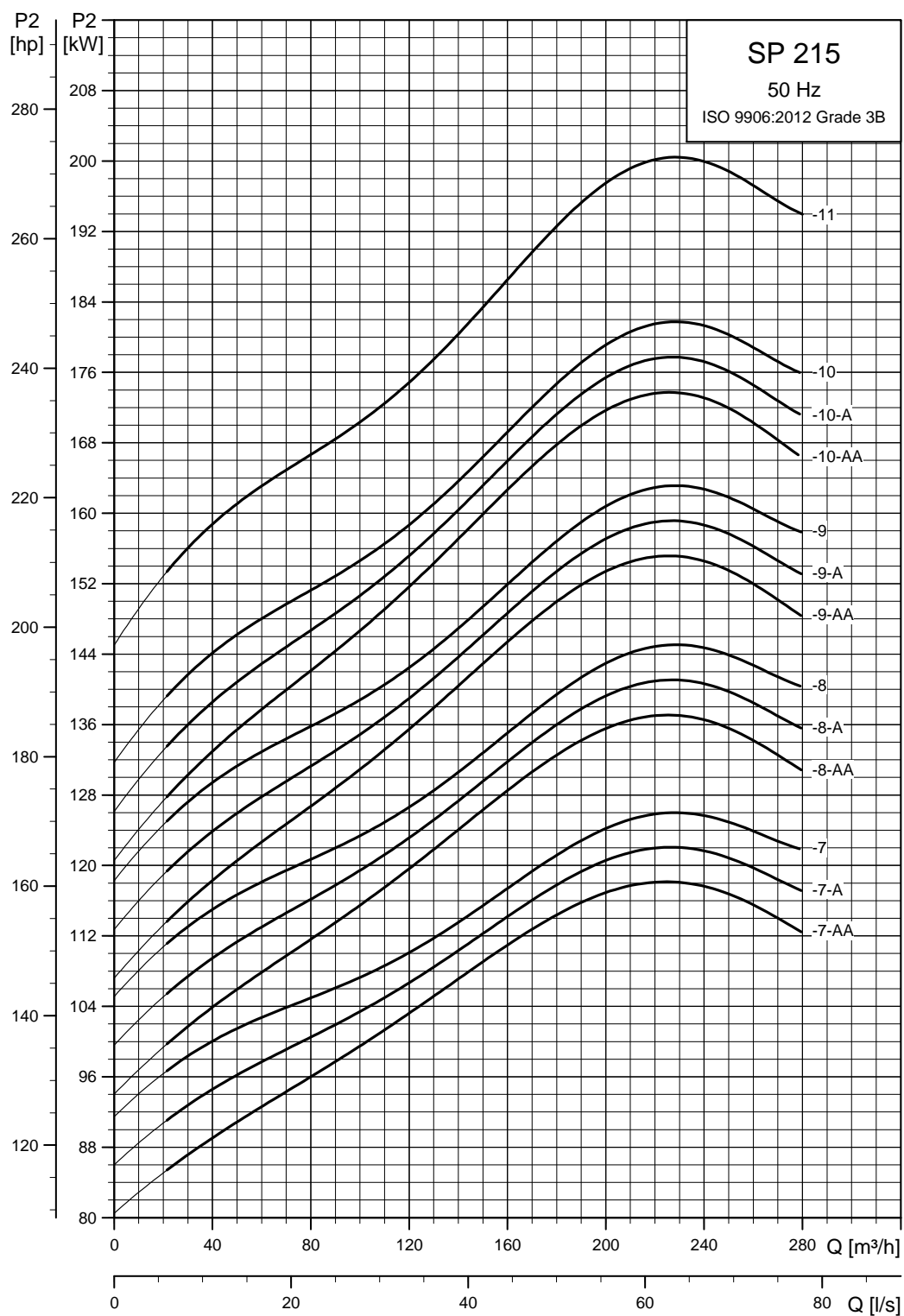

TM01 8788 4702

7. Electrical data

1 x 230 V, submersible motors "MS"

Electrical data											Dimensions		
Motor			Full-load current I_n [A]	Motor efficiency [%]			Power factor			$\frac{I_{st}}{I_n}$	Diameter [mm]	Length [mm]	Weight [kg]
Type	Size	Power [kW]		$\eta_{50\%}$	$\eta_{75\%}$	$\eta_{100\%}$	$\cos \phi_{50\%}$	$\cos \phi_{75\%}$	$\cos \phi_{100\%}$				
MS 402	4"	0.37	3.95	48.0	54.0	57.0	0.58	0.68	0.77	3.4*	95	256	6.8
MS 402	4"	0.55	5.80	49.5	56.5	59.5	0.52	0.65	0.74	3.5*	95	291	8.2
MS 402	4"	0.75	7.45	52.0	58.0	60.0	0.57	0.69	0.79	3.6*	95	306	8.9
MS 402	4"	1.1	7.30	62.0	69.5	72.5	0.99	0.99	0.99	4.3*	95	346	10.5
MS 402	4"	1.5	10.2	56.5	66.5	71.0	0.91	0.96	0.98	3.9	95	346	11.0
MS 4000 (R)	4"	2.2	14.0	67.0	73.0	75.0	0.91	0.94	0.96	4.4	95	576	21.0

* Applies to 3-wire motors.

MS 402 2-wire motors incorporate motor protection and can therefore you can connect them directly to the mains.

3 x 230 V, submersible motors "MS"

Electrical data											Dimensions		
Motor			Full-load current I_n [A]	Motor efficiency [%]			Power factor			$\frac{I_{st}}{I_n}$	Diameter [mm]	Length [mm]	Weight [kg]
Type	Size	Power [kW]		$\eta_{50\%}$	$\eta_{75\%}$	$\eta_{100\%}$	$\cos \phi_{50\%}$	$\cos \phi_{75\%}$	$\cos \phi_{100\%}$				
MS 402	4"	0.37	2.55	51.0	59.5	64.0	0.44	0.55	0.64	3.7	95	226	5.5
MS 402	4"	0.55	4.00	48.5	57.0	64.0	0.42	0.52	0.64	3.5	95	241	6.3
MS 402	4"	0.75	4.20	64.0	69.5	73.0	0.50	0.62	0.72	4.6	95	276	7.7
MS 4000R	4"	0.75	3.35	66.8	71.1	72.9	0.66	0.76	0.82	5.1	95	401	13.0
MS 402	4"	1.1	6.20	62.5	69.0	73.0	0.47	0.59	0.72	4.6	95	306	8.9
MS 4000R	4"	1.1	5.00	69.1	73.2	75.0	0.57	0.70	0.78	5.2	95	416	14.0
MS 402	4"	1.5	7.65	68.0	73.0	75.0	0.50	0.64	0.75	5.0	95	346	10.5
MS 4000R	4"	1.5	7.40	66.6	71.4	72.9	0.53	0.66	0.74	4.5	95	416	14.0
MS 402	4"	2.2	10.0	72.5	75.5	76.0	0.56	0.71	0.82	4.7	95	346	11.9
MS 4000 (R)	4"	2.2	11.6	64.5	70.8	73.3	0.44	0.58	0.69	4.2	95	456	16.0
MS 4000 (R)	4"	3.0	14.6	67.5	72.8	74.6	0.48	0.62	0.73	4.4	95	496	17.0
MS 4000 (R)	4"	4.0	17.6	73.9	77.4	77.9	0.52	0.67	0.77	4.9	95	576	21.0
MS 4000 (R)	4"	5.5	24.2	76.0	78.8	79.6	0.51	0.66	0.76	4.9	95	676	26.0
MS 6000 (R)	6"	5.5	24.8	77.0	79.0	80.0	0.51	0.64	0.73	4.5	139.5	544	35.5
MS 6000 (R)	6"	7.5	32.0	79.0	82.0	82.0	0.55	0.68	0.77	4.6	139.5	574	37.0
MS 6000 (R)	6"	9.2	39.5	77.0	80.0	80.0	0.56	0.70	0.78	4.8	139.5	604	42.5
MS 6000 (R)	6"	11	45.0	81.0	82.5	82.5	0.60	0.72	0.79	4.8	139.5	634	45.5
MS 6000 (R)	6"	13	54.5	81.0	82.5	82.5	0.58	0.71	0.78	4.8	139.5	664	48.5
MS 6000 (R)	6"	15	62.0	82.0	83.5	83.5	0.59	0.71	0.78	5.2	139.5	699	52.5
MS 6000 (R)	6"	18.5	76.5	82.5	84.5	84.0	0.56	0.69	0.77	5.3	139.5	754	58.0
MS 6000 (R)	6"	22	87.5	84.5	85.0	84.0	0.61	0.74	0.81	5.2	139.5	814	64.0
MS 6000 (R)	6"	26	104	83.5	84.0	83.5	0.61	0.73	0.81	5.0	139.5	874	69.5
MS 6000 (R)	6"	30	120	83.0	84.0	83.0	0.59	0.72	0.80	5.0	139.5	944	77.5

MS 402: Data apply to 3 x 220 V.

3 x 230 V, submersible rewindable motors "MMS"

Electrical data										Dimensions			
Motor			Full-load current I_n [A]	Motor efficiency [%]			Power factor			$\frac{I_{st}}{I_n}$	Diameter [mm]	Length [mm]	Weight [kg]
Type	Size	Power [kW]		$\eta_{50\%}$	$\eta_{75\%}$	$\eta_{100\%}$	$\cos \phi_{50\%}$	$\cos \phi_{75\%}$	$\cos \phi_{100\%}$				
MMS 6 (N, R)	6"	5.5	25.0	71	75	76	0.61	0.72	0.78	3.5	144	807	50
MMS 6 (N, R)	6"	7.5	33.5	72	76	77	0.59	0.71	0.78	3.5	144	837	53
MMS 6 (N, R)	6"	9.2	40.5	74	77	78	0.59	0.71	0.78	3.6	144	867	55
MMS 6 (N, R)	6"	11	50.0	74	78	79	0.53	0.66	0.74	3.8	144	897	60
MMS 6 (N, R)	6"	13	56.0	77	80	80	0.57	0.69	0.77	3.9	144	927	65
MMS 6 (N, R)	6"	15	62.5	79	82	82	0.58	0.71	0.79	4.3	144	997	77
MMS 6 (N, R)	6"	18.5	75.0	80	82	82	0.61	0.75	0.81	4.2	144	1057	83
MMS 6 (N, R)	6"	22	87.0	82	84	83	0.61	0.74	0.81	5.3	144	1087	95
MMS 6 (N, R)	6"	26	106	81	83	83	0.57	0.7	0.78	5.6	144	1157	105
MMS 6 (N, R)	6"	30	118	82	83	82	0.63	0.76	0.82	4.8	144	1212	110
MMS 6 (N, R)	6"	37	148	82	84	83	0.59	0.72	0.81	5.4	144	1312	120
MMS 8000 (N, R)	8"	22	82.5	80	84	84	0.71	0.80	0.84	5.3	192	1010	126
MMS 8000 (N, R)	8"	26	95.5	81	84	84	0.76	0.83	0.86	5.1	192	1050	134
MMS 8000 (N, R)	8"	30	110	83	85	86	0.71	0.80	0.84	5.7	192	1110	146
MMS 8000 (N, R)	8"	37	134	83	86	86	0.73	0.82	0.85	5.7	192	1160	156
MMS 8000 (N, R)	8"	45	168	84	87	88	0.62	0.74	0.81	6.0	192	1270	177
MMS 8000 (N, R)	8"	55	214	84	87	88	0.57	0.70	0.77	5.9	192	1350	192
MMS 8000 (N, R)	8"	63	210	87	89	89	0.81	0.87	0.90	5.7	192	1490	218
MMS 10000 (N, R)	10"	75	270	84	86	86	0.72	0.81	0.85	5.4	237	1500	330
MMS 10000 (N, R)	10"	92	345	83	85	86	0.65	0.77	0.82	5.6	237	1690	385
MMS 10000 (N, R)	10"	110	385	85	86	86	0.80	0.86	0.88	5.7	237	1870	435

3 x 400 V, submersible motors "MS"

Electrical data										Dimensions			
Motor			Full-load current I_n [A]	Motor efficiency [%]			Power factor			$\frac{I_{st}}{I_n}$	Diameter [mm]	Length [mm]	Weight [kg]
Type	Size	Power [kW]		$\eta_{50\%}$	$\eta_{75\%}$	$\eta_{100\%}$	$\cos \phi_{50\%}$	$\cos \phi_{75\%}$	$\cos \phi_{100\%}$				
MS 402	4"	0.37	1.40	51.0	59.5	64.0	0.44	0.55	0.64	3.7	95	226	5.5
MS 402	4"	0.55	2.20	48.5	57.0	64.0	0.42	0.52	0.64	3.5	95	241	6.3
MS 402	4"	0.75	2.30	64.0	69.5	73.0	0.50	0.62	0.72	4.7	95	276	7.7
MS 4000R	4"	0.75	1.84	68.1	71.6	72.8	0.69	0.79	0.84	4.9	95	401	13.0
MS 402	4"	1.1	3.40	62.5	69.0	73.0	0.47	0.59	0.72	4.6	95	306	8.9
MS 4000R	4"	1.1	2.75	70.3	74.0	74.4	0.62	0.74	0.82	5.1	95	416	14.0
MS 402	4"	1.5	4.20	68.0	73.0	75.0	0.50	0.64	0.75	5.0	95	346	10.5
MS 4000R	4"	1.5	4.00	69.1	72.7	73.7	0.55	0.69	0.78	4.3	95	416	14.0
MS 402	4"	2.2	5.50	72.5	75.5	76.0	0.56	0.71	0.82	4.7	95	346	11.9
MS 4000 (R)	4"	2.2	6.05	67.9	73.1	74.5	0.49	0.63	0.74	4.5	95	456	16.0
MS 4000 (R)	4"	3.0	7.85	71.5	74.5	75.2	0.53	0.67	0.77	4.5	95	496	17.0
MS 4000 (R)	4"	4.0	9.60	77.3	78.4	78.0	0.57	0.71	0.80	4.8	95	576	21.0
MS 4000 (R)	4"	5.5	13.0	78.5	80.1	79.8	0.57	0.72	0.81	4.9	95	676	26.0
MS 4000 (R)	4"	7.5	18.8	75.2	78.2	78.2	0.52	0.67	0.78	4.5	95	776	31.0
MS 6000 (R)	6"	5.5	13.6	78.0	80.0	80.5	0.55	0.67	0.77	4.4	139.5	544	35.5
MS 6000 (R)	6"	7.5	17.6	81.5	82.0	82.0	0.60	0.73	0.80	4.3	139.5	574	37.0
MS 6000 (R)	6"	9.2	21.8	78.0	80.0	79.5	0.61	0.73	0.81	4.6	139.5	604	42.5
MS 6000 (R)	6"	11	24.8	82.0	83.0	82.5	0.65	0.77	0.83	4.7	139.5	634	45.5
MS 6000 (R)	6"	13	30.0	82.5	83.5	82.0	0.62	0.74	0.81	4.6	139.5	664	48.5
MS 6000 (R)	6"	15	34.0	82.0	83.5	83.5	0.64	0.76	0.82	5.0	139.5	699	52.5
MS 6000 (R)	6"	18.5	42.0	83.5	84.5	83.5	0.62	0.73	0.81	5.1	139.5	754	58.0
MS 6000 (R)	6"	22	48.0	84.5	85.0	83.5	0.67	0.77	0.84	5.0	139.5	814	64.0
MS 6000 (R)	6"	26	57.0	84.5	85.0	84.0	0.66	0.77	0.84	4.9	139.5	874	69.5
MS 6000 (R)	6"	30	66.5	84.5	85.0	84.0	0.64	0.77	0.83	4.9	139.5	944	77.5

3 x 400 V, submersible motors "MS T60" (60 °C)

Electrical data										Dimensions			
Motor			Full-load current I_n [A]	Motor efficiency [%]			Power factor			$\frac{I_{st}}{I_n}$	Diameter [mm]	Length [mm]	Weight [kg]
Type	Size	Power [kW]		$\eta_{50\%}$	$\eta_{75\%}$	$\eta_{100\%}$	$\cos \phi_{50\%}$	$\cos \phi_{75\%}$	$\cos \phi_{100\%}$				
MS 4000 T60 (R)	4"	2.2	5.9	72.5	76.5	77.0	0.59	0.71	0.80	5.0	95	496	17.0
MS 4000 T60 (R)	4"	3.0	7.5	75.0	79.0	80.0	0.58	0.71	0.79	5.4	95	576	21.0
MS 4000 T60 (R)	4"	4.0	9.75	75.5	79.5	79.5	0.67	0.78	0.84	5.3	95	676	26.0
MS 4000 T60 (R)	4"	5.5	14.4	77.5	79.6	79.8	0.55	0.69	0.79	5.0	95	776	42.5
MS 6000 T60 (R)	6"	5.5	13.2	75.0	79.0	80.0	0.63	0.74	0.80	6.0	139.5	604	42.5
MS 6000 T60 (R)	6"	7.5	17.0	79.5	81.0	81.5	0.71	0.80	0.84	4.9	139.5	634	45.5
MS 6000 T60 (R)	6"	9.2	20.2	80.0	82.5	82.5	0.72	0.80	0.85	5.5	139.5	664	48.5
MS 6000 T60 (R)	6"	11	24.2	82.0	83.0	83.0	0.74	0.83	0.86	5.0	139.5	699	52.5
MS 6000 T60 (R)	6"	13	28.5	82.0	83.5	84.0	0.71	0.80	0.84	5.4	139.5	754	58.0
MS 6000 T60 (R)	6"	15	33.0	82.0	83.5	84.0	0.68	0.79	0.84	5.9	139.5	814	64.0
MS 6000 T60 (R)	6"	18.5	39.5	84.0	85.5	85.0	0.71	0.80	0.85	5.8	139.5	874	69.5
MS 6000 T60 (R)	6"	22	48.0	83.5	84.5	84.5	0.71	0.80	0.85	5.6	139.5	944	77.5

3 x 400 V, submersible rewindable motors "MMS"

Electrical data										Dimensions			
Motor			Full-load current I_n [A]	Motor efficiency [%]			Power factor			$\frac{I_{st}}{I_n}$	Diameter [mm]	Length [mm]	Weight [kg]
Type	Size	Power [kW]		$\eta_{50\%}$	$\eta_{75\%}$	$\eta_{100\%}$	$\cos \phi_{50\%}$	$\cos \phi_{75\%}$	$\cos \phi_{100\%}$				
MMS 6 (N, R)	6"	5.5	14.4	71	75	76	0.60	0.71	0.77	3.5	144	807	50
MMS 6 (N, R)	6"	7.5	19.2	72	76	77	0.59	0.71	0.78	3.6	144	837	53
MMS 6 (N, R)	6"	9.2	22.8	75	78	78	0.61	0.73	0.79	3.5	144	867	55
MMS 6 (N, R)	6"	11	27.5	74	78	78	0.58	0.71	0.79	3.7	144	897	60
MMS 6 (N, R)	6"	13	32.0	77	79	79	0.63	0.75	0.79	3.8	144	927	65
MMS 6 (N, R)	6"	15	36.5	76	79	79	0.59	0.72	0.80	4.2	144	997	77
MMS 6 (N, R)	6"	18.5	43.5	79	81	81	0.60	0.72	0.80	4.5	144	1057	83
MMS 6 (N, R)	6"	22	51.5	81	83	83	0.57	0.70	0.79	5.5	144	1087	95
MMS 6 (N, R)	6"	26	61.0	81	83	83	0.57	0.70	0.78	5.7	144	1157	105
MMS 6 (N, R)	6"	30	68.2	83	84	84	0.61	0.73	0.81	5.0	144	1212	110
MMS 6 (N, R)	6"	37	84.5	82	84	83	0.60	0.73	0.81	5.1	144	1312	120
MMS 8000 (N, R)	8"	22	48.0	80	82	82	0.72	0.81	0.84	5.3	192	1010	126
MMS 8000 (N, R)	8"	26	56.5	80	82	82	0.76	0.83	0.85	5.1	192	1050	134
MMS 8000 (N, R)	8"	30	64.0	82	84	84	0.74	0.82	0.85	5.7	192	1110	146
MMS 8000 (N, R)	8"	37	78.5	82	84	84	0.74	0.82	0.85	5.7	192	1160	156
MMS 8000 (N, R)	8"	45	96.5	84	86	86	0.65	0.76	0.82	6.0	192	1270	177
MMS 8000 (N, R)	8"	55	114	84	86	86	0.72	0.81	0.85	5.9	192	1350	192
MMS 8000 (N, R)	8"	63	132	85	87	87	0.66	0.78	0.83	5.7	192	1490	218
MMS 8000 (N, R)	8"	75	152	86	87	87	0.71	0.82	0.86	5.8	192	1590	237
MMS 8000 (N, R)	8"	92	186	87	88	87	0.72	0.82	0.86	5.9	192	1830	283
MMS 8000 (N, R)	8"	110	224	86	87	87	0.73	0.83	0.87	5.8	192	2060	333
MMS 10000 (N, R)	10"	75	156	84	86	87	0.70	0.80	0.84	5.4	237	1400	280
MMS 10000 (N, R)	10"	92	194	84	87	87	0.67	0.78	0.82	5.6	237	1500	330
MMS 10000 (N, R)	10"	110	228	85	87	88	0.70	0.79	0.84	5.7	237	1690	385
MMS 10000 (N, R)	10"	132	270	85	88	88	0.71	0.81	0.84	5.7	237	1870	435
MMS 10000 (N, R)	10"	147	315	84	87	87	0.64	0.75	0.81	6.2	237	2070	500
MMS 10000 (N, R)	10"	170	365	84	86	87	0.64	0.75	0.81	6.0	237	2220	540
MMS 10000 (N, R)	10"	190	425	83	86	87	0.60	0.72	0.79	5.9	237	2400	580
MMS 12000 (N, R)	12"	147	305	84	87	88	0.66	0.77	0.83	6.2	286	1790	565
MMS 12000 (N, R)	12"	170	345	85	87	88	0.69	0.79	0.85	6.1	286	1880	605
MMS 12000 (N, R)	12"	190	390	85	87	88	0.68	0.79	0.84	6.2	286	1980	650
MMS 12000 (N, R)	12"	220	445	85	87	88	0.69	0.80	0.85	6.1	286	2140	700
MMS 12000 (N, R)	12"	250	505	85	87	88	0.69	0.80	0.85	5.9	286	2290	775

3 x 500 V, submersible motors "MS"

Electrical data										Dimensions			
Motor			Full-load current I_n [A]	Motor efficiency [%]			Power factor			$\frac{I_{st}}{I_n}$	Diameter [mm]	Length [mm]	Weight [kg]
Type	Size	Power [kW]		η_{50} %	η_{75} %	η_{100} %	$\cos \phi_{50}$ %	$\cos \phi_{75}$ %	$\cos \phi_{100}$ %				
MS 4000R	4"	0.75	1.5	69.1	72.7	73.7	0.55	0.69	0.78	4.7	95	401	13.0
MS 4000R	4"	1.1	2.2	70.3	74.0	74.4	0.62	0.74	0.82	5.0	95	416	14.0
MS 4000R	4"	1.5	3.2	69.1	72.7	73.7	0.55	0.69	0.78	4.4	95	416	14.0
MS 4000 (R)	4"	2.2	4.9	67.9	73.1	74.5	0.49	0.63	0.74	4.3	95	456	16.0
MS 4000 (R)	4"	3.0	6.3	71.5	74.5	75.2	0.53	0.67	0.77	4.6	95	496	17.0
MS 4000 (R)	4"	4.0	7.7	77.3	78.4	78.0	0.57	0.71	0.81	4.8	95	576	21.0
MS 4000 (R)	4"	5.5	10.4	78.5	80.1	79.8	0.57	0.72	0.81	4.9	95	676	26.0
MS 4000 (R)	4"	7.5	15.0	75.2	78.2	78.2	0.52	0.67	0.78	4.5	95	776	31.0
MS 6000 (R)	6"	5.5	10.8	78.0	80.0	80.5	0.56	0.67	0.77	4.4	139.5	544	35.5
MS 6000 (R)	6"	7.5	14.0	81.0	82.5	82.5	0.60	0.72	0.8	4.5	139.5	574	37.0
MS 6000 (R)	6"	9.2	17.4	78.0	80.0	80.0	0.62	0.73	0.81	4.6	139.5	604	42.5
MS 6000 (R)	6"	11	19.8	82.0	83.5	82.0	0.65	0.77	0.83	4.7	139.5	634	45.5
MS 6000 (R)	6"	13	24.0	82.5	83.5	82.5	0.62	0.74	0.81	4.6	139.5	664	68.5
MS 6000 (R)	6"	15	27.0	82.0	83.0	83.0	0.65	0.76	0.82	5.0	139.5	699	52.5
MS 6000 (R)	6"	18.5	33.5	83.5	84.5	84.0	0.61	0.73	0.81	5.1	139.5	754	58.0
MS 6000 (R)	6"	22	38.5	84.5	85.0	84.0	0.67	0.77	0.84	5.0	139.5	814	64.0
MS 6000 (R)	6"	26	45.5	84.5	85.0	84.0	0.66	0.77	0.84	4.9	139.5	874	69.5
MS 6000 (R)	6"	30	53.0	85.0	84.5	83.5	0.64	0.76	0.83	4.9	139.5	945	77.5

3 x 500 V, submersible motors "MS T60"

Electrical data										Dimensions			
Motor			Full-load current I_n [A]	Motor efficiency [%]			Power factor			$\frac{I_{st}}{I_n}$	Diameter [mm]	Length [mm]	Weight [kg]
Type	Size	Power [kW]		η_{50} %	η_{75} %	η_{100} %	$\cos \phi_{50}$ %	$\cos \phi_{75}$ %	$\cos \phi_{100}$ %				
MS 4000I (R)	4"	2.2	4.7	72.5	76.5	77.0	0.59	0.71	0.80	4.9	95	496	17.0
MS 4000I (R)	4"	3.0	6.2	75.0	79.0	80.0	0.58	0.71	0.79	5.4	95	576	21.0
MS 4000I (R)	4"	4.0	7.8	75.5	79.5	79.5	0.67	0.78	0.84	5.2	95	676	26.0
MS 4000I (R)	4"	5.5	11.6	77.0	79.5	80.0	0.55	0.68	0.78	5.0	95	776	31.0
MS 6000I (R)	6"	5.5	10.6	75.0	78.5	80.0	0.63	0.74	0.80	6.0	139.5	604	42.5
MS 6000I (R)	6"	7.5	13.6	79.5	81.0	81.5	0.71	0.80	0.84	4.9	139.5	634	45.5
MS 6000I (R)	6"	9.2	16.2	80.0	83.0	83.0	0.72	0.81	0.84	5.5	139.5	664	48.5
MS 6000I (R)	6"	11	19.4	82.0	83.5	83.5	0.74	0.82	0.86	5.0	139.5	699	52.5
MS 6000I (R)	6"	13	22.8	82.5	83.5	84.0	0.71	0.80	0.84	5.4	139.5	754	58.0
MS 6000I (R)	6"	15	26.4	82.0	84.0	84.5	0.71	0.79	0.84	5.9	139.5	814	64.0
MS 6000I (R)	6"	18.5	31.5	84.5	85.5	85.0	0.71	0.81	0.85	5.8	139.5	874	69.5
MS 6000I (R)	6"	22	38.5	84.0	84.5	84.5	0.71	0.80	0.85	5.6	139.5	944	77.5

3 x 500 V, submersible rewindable motors "MMS"

Electrical data										Dimensions			
Motor			Full-load current I_n [A]	Motor efficiency [%]			Power factor			$\frac{I_{st}}{I_n}$	Diameter [mm]	Length [mm]	Weight [kg]
Type	Size	Power [kW]		$\eta_{50\%}$	$\eta_{75\%}$	$\eta_{100\%}$	$\cos \phi_{50\%}$	$\cos \phi_{75\%}$	$\cos \phi_{100\%}$				
MMS 6 (N, R)	6"	9.2	18.6	72	75	75	0.61	0.74	0.81	3.5	144	867	55
MMS 6 (N, R)	6"	11	21.8	74	77	76	0.64	0.75	0.81	3.5	144	897	60
MMS 6 (N, R)	6"	13	25.0	76	78	78	0.62	0.75	0.81	3.7	144	927	65
MMS 6 (N, R)	6"	15	28.0	77	80	79	0.65	0.77	0.82	3.9	144	997	77
MMS 6 (N, R)	6"	18.5	34.5	78	80	79	0.65	0.77	0.83	4.0	144	1057	83
MMS 6 (N, R)	6"	22	39.5	82	82	80	0.69	0.80	0.84	4.8	144	1087	95
MMS 6 (N, R)	6"	26	47.0	81	82	80	0.67	0.79	0.84	5.0	144	1157	105
MMS 6 (N, R)	6"	30	54.5	80	81	79	0.67	0.79	0.84	4.5	144	1212	110
MMS 6 (N, R)	6"	37	66.5	81	82	80	0.66	0.78	0.85	5.1	144	1312	120
MMS 8000 (N, R)	8"	22	37.5	81	83	83	0.79	0.85	0.87	4.7	144	1010	126
MMS 8000 (N, R)	8"	26	44.0	81	84	83	0.80	0.85	0.86	4.8	192	1050	134
MMS 8000 (N, R)	8"	30	49.5	83	85	85	0.78	0.85	0.86	5.6	192	1110	146
MMS 8000 (N, R)	8"	37	60.5	84	85	85	0.82	0.87	0.87	5.6	192	1160	156
MMS 8000 (N, R)	8"	45	72.0	85	87	87	0.73	0.82	0.86	6.2	192	1270	177
MMS 8000 (N, R)	8"	55	88.5	86	88	88	0.71	0.81	0.86	6.1	192	1350	192
MMS 8000 (N, R)	8"	63	96.5	87	89	88	0.82	0.88	0.90	6.1	192	1490	218
MMS 8000 (N, R)	8"	75	114	88	89	88	0.85	0.89	0.90	5.6	192	1590	237
MMS 8000 (N, R)	8"	92	142	88	87	88	0.81	0.87	0.89	5.3	192	1830	283
MMS 8000 (N, R)	8"	110	182	86	88	88	0.67	0.78	0.84	5.3	192	2060	333
MMS 10000 (N, R)	10"	75	122	85	87	87	0.77	0.84	0.86	5.3	237	1400	280
MMS 10000 (N, R)	10"	92	150	85	87	87	0.74	0.82	0.85	5.3	237	1500	330
MMS 10000 (N, R)	10"	110	178	85	87	88	0.76	0.84	0.86	5.4	237	1690	385
MMS 10000 (N, R)	10"	132	210	86	88	87	0.82	0.87	0.88	5.0	237	1870	435
MMS 10000 (N, R)	10"	147	236	85	88	88	0.74	0.83	0.86	5.8	237	2070	500
MMS 10000 (N, R)	10"	170	270	86	88	88	0.78	0.85	0.87	5.4	237	2220	540
MMS 10000 (N, R)	10"	190	305	86	88	87	0.80	0.86	0.87	5.3	237	2400	580
MMS 12000 (N)	12"	147	218	86	89	90	0.80	0.88	0.91	6.9	286	1790	565
MMS 12000 (N)	12"	170	265	87	89	90	0.74	0.82	0.86	6.0	286	1880	605
MMS 12000 (N)	12"	190	220	88	90	91	0.85	0.91	0.93	7.8	286	1980	650
MMS 12000 (N)	12"	220	335	88	90	90	0.79	0.86	0.88	5.8	286	2140	700
MMS 12000 (N)	12"	250	375	87	90	91	0.75	0.85	0.89	6.3	286	2290	775

8. Electrical accessories

MP 204 motor protector



TM056456 3712

Fig. 20 MP 204 motor protector

The MP 204 is an electronic motor protector designed for the protection of an asynchronous motor or a pump. You cannot use the motor protector in installations where a frequency converter is installed.

The motor protector operates with two sets of limits:

- a set of warning limits
- a set of trip limits.

If one or more of the warning limits are exceeded, the motor will continue to run, but the warnings will appear in the display of the motor protector.

Some values only have a warning limit.

You can read out the warning with the Grundfos GO.

If one of the trip limits is exceeded, the trip relay will stop the motor. At the same time, the signal relay is operating to indicate that the limit has been exceeded.

Applications

You can use MP 204 as a stand-alone motor protector. You can monitor the motor protector via a Grundfos GENibus.

The motor protector protects the motor primarily by measuring the motor current by means of a true RMS measurement.

The motor protector is designed for single- and three-phase motors. In single-phase motors, the starting and run capacitors are also measured. $\cos \varphi$ is measured in both single- and three-phase systems.

Benefits

The motor protector offers these benefits:

- suitable for both single- and three-phase motors
- dry-running protection
- overload protection
- very high accuracy
- made for submersible pumps.

The many monitoring options of the motor protector

The motor protector monitors the following parameters:

- insulation resistance before startup
- temperature (Tempcon, Pt sensor and PTC/thermal switch)
- overload and underload
- overvoltage and undervoltage
- phase sequence
- phase failure
- power factor
- power consumption
- harmonic distortion
- operating hours and number of starts.

Five sizes of single-turn transformers, 120-999 A.

Note: Monitoring of motor temperature is not possible when you use single-turn transformers.



TM03 2033 3505

Fig. 21 Single-turn transformers

Product numbers, MP 204

Product	Product number
MP 204	96079927
Single-turn transformers	
Current transformer ratio: 200:5, $I_{max.} = 120$ A	96095274
Current transformer ratio: 300:5, $I_{max.} = 300$ A	96095275
Current transformer ratio: 500:5, $I_{max.} = 500$ A	96095276
Current transformer ratio: 750:5, $I_{max.} = 750$ A	96095277
Current transformer ratio: 1000:5, $I_{max.} = 1000$ A	96095278

Technical data, MP 204

Enclosure class	IP20
Ambient temperature	-20 - 60 °C
Relative air humidity	99 %
Voltage range	100-480 VAC
Current range	3-999 A
Frequency	50 to 60 Hz
IEC trip class	1-45
Special Grundfos trip class	0.1 - 30 s
Voltage variation	- 25 %/+ 15 % of rated voltage
Approvals	EN 60947, EN 60335, UL/CSA 508
Marking	CE, cUL, C-tick
Consumption	Max. 5 W
Plastic type	Black PC/ABS

Electrical data, MP 204

	Measuring range	Accuracy	Resolution
Current without external current transformers	3-120 A	± 1 %	0.1 A
Current with external current transformers	120-999 A	± 1 %	1 A
Phase-to-phase voltage	80-610 VAC	± 1 %	1 V
Frequency	47-63 Hz	± 1 %	0.5 Hz
Power	0-1 MW	± 2 %	1 W
Power factor	0 - 0.99	± 2 %	0.01
Energy consumption	0-4 x 10 ⁹ kWh	± 5 %	1 kWh

For further information about MP 204 and pump controls, see the literature available on <https://product-selection.grundfos.com> (Grundfos Product Center).

IO 112 module

Product	Description	Product number
	<p>The IO 112 is a measuring module and a single-channel protection unit for use in connection with the MP 204 motor protector. You can use the module for protection of the pump against other factors than the electrical conditions, for instance dry running. You can also use it as a stand-alone protection module.</p> <p>The IO 112 interface has three inputs for measured values, one potentiometer for setting of limits and indicator lights indicating the following:</p> <ul style="list-style-type: none"> measured value of the input value of the limit set alarm source pump status. <p>Electrical data</p> <ul style="list-style-type: none"> Supply voltage: 24 VAC ± 10 %, 50/60 Hz or 24 VDC ± 10 %. Supply current: Min. 2.4 A, max. 8 A. Power consumption: Max. 5 W. Ambient temperature: -25 - 65 °C. Enclosure class: IP20. 	96651601

TM03 5811 3906

Control MP 204

Product	Description	Product number
	<p>The Control MP 204 control cabinets are supplied with all necessary components. Three types of control cabinets are available, depending on functions and starting method. The control cabinets are designed for installation in a control cabinet for outdoor use. The Control MP 204 control cabinets have a built-in main switch and a thermal magnetic circuit breaker.</p> <p>Functions:</p> <p>Digital input</p> <ul style="list-style-type: none"> Float switch or pressure relay (if no IO 112 is used). <p>Analog input</p> <ul style="list-style-type: none"> Too high motor temperature (Tempcon) thermistors/PTC, pump pressure sensor, 4-20 mA (with IO 112). <p>Relay output</p> <ul style="list-style-type: none"> Pump alarm. <p>Communication</p> <ul style="list-style-type: none"> Grundfos Remote Management. GSM/GPRS (IO 112 not supported) Modbus RTU wired (IO 112 not supported) Profibus DP (IO 112 not supported). <p>Protection</p> <ul style="list-style-type: none"> Protects the pump against short-circuit. 	Consult https://product-selection.grundfos.com (Grundfos Product Center) for product selection.

TM05 3695 1612

CUE frequency converter

The Grundfos CUE is a series of external frequency converters designed for speed control of a wide range of Grundfos pumps.

When a CUE frequency converter is installed, the motor requires no further motor protection.

The CUE frequency converter offers quick and easy setup and commissioning compared to a standard frequency converter because of the startup guide.

Simply key in application-specific variables such as motor data, pump family, control function (for example constant pressure), sensor type and setpoint, and the frequency converter will automatically set all necessary parameters.

The frequency converter enables gentle pumping and thereby protects the water reservoir and the rest of the distribution system, as water hammer can be avoided by adjusting ramp times up and down.

Overview of the CUE range

Supply voltage [V]	Power range [kW]						
	0.55	0.75	1.1	7.5	11	45	250
3 x 525-690							
3 x 525-600							
3 x 380-500							
3 x 200-240							
1 x 200-240							

The frequency converter is available in two enclosure classes:

- IP20/21
- IP54/55.

RFI filters

To meet the EMC requirements, the frequency converter comes with the following types of built-in radio frequency interference filter (RFI).

Voltage [V]	Typical shaft power, P2 [kW]	RFI filter type	Application
1 x 200-240	1.1 - 7.5	C1	Domestic
3 x 200-240	0.75 - 45	C1	
3 x 380-500	0.55 - 90	C1	Domestic/ industry
	110-250	C2	
3 x 525-600	0.75 - 7.5	C3	Industry
3 x 525-690	11-25	C3	



GrA4404 3407

Fig. 22 The CUE range

Functions

The frequency converter has a wide range of pump-specific functions, such as:

- constant pressure
- constant level
- constant flow rate
- constant temperature
- constant curve.

CUE features

- Startup guide
The frequency converter incorporates an innovative startup guide for the general setting of the frequency converter including the setting of the correct direction of rotation.
The startup guide starts the first time the frequency converter is connected to the power supply.
- Check of direction of rotation.
- Duty/standby operation.
- Dry-running protection.
- Low-flow stop function.

Accessories for the CUE frequency converter

Grundfos offers various accessories for the frequency converter.

MCB 114 sensor input module

The MCB 114 sensor input module offers additional analog inputs for the frequency converter:

- 1 analog input, 0/4-20 mA
- 2 inputs for Pt100 and Pt1000 temperature sensors.

Sensors

You can use the following sensors can be used in connection with the frequency converter. All sensors are with 4-20 mA output signal.

- pressure sensors, up to 25 bar
- temperature sensors
- differential-pressure sensors
- differential-temperature sensors
- flowmeters
- potentiometer box for external setpoint setting.

Output filters

Output filters are used primarily to protect the motor against overvoltage and increased operating temperature. However, output filters can also be used to reduce acoustic noise from the motor.

Grundfos offers two types of output filter as accessories for the frequency converter:

- sine-wave filters.
- du/dt filters.

The frequency converter must have an output filter to limit voltage peaks and to reduce dU/dt which causes stress on the isolation of the motor. The maximum voltage must be reduced to a level less than 850 V (except for the MS 402). dU/dt must also be limited according to the following table.

Max peak voltage and max dU/dt for SP Pumps		
Motor series	Max. voltage peak	Max. dU/dt
MS 402	650 V Phase - Phase	2000 V/micro s.
MS 4000	850 V Phase - Phase	2000 V/micro s.
MS 6 / MS 6000	850 V Phase - Phase	2000 V/micro s.
MMS 6 / MMS 6000	850 V Phase - Ground	500 V/micro s.
MMS 8000	850 V Phase - Ground	500 V/micro s.
MMS 10000	850 V Phase - Ground	500 V/micro s.
MMS 12000	850 V Phase - Ground	500 V/micro s.

Note: Cables used in CUE installations

Note: When the frequency converter is installed in connection with SP pumps, we distinguish between two types of installation:

- installation in EMC-insensitive sites. See fig. 23.
- installation in EMC-sensitive sites. See fig. 24.

The two types of installation are different when it comes to the use of screened cable.

Note: Drop cables are always unscreened.

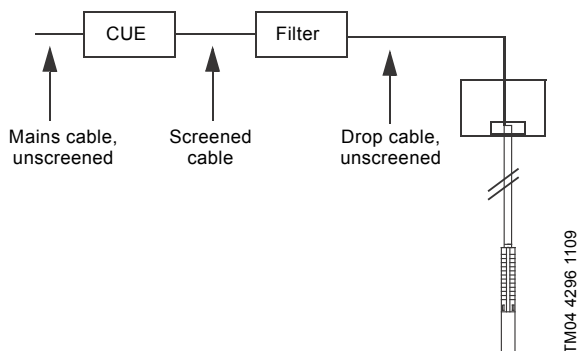

Fig. 23 Example of installation in EMC-insensitive sites

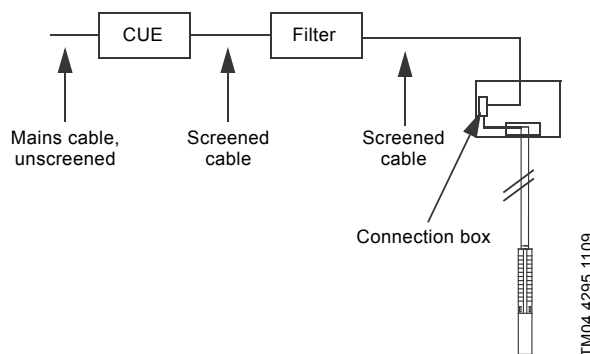

Fig. 24 Example of installation in EMC-sensitive sites

Screened cables are required in those parts of the installation where the surroundings must be protected against EMC.

CUE is the right choice of frequency converter in SP installations as it meets all basic issues.

The frequency converter has a pre-installed startup guide which takes the installer through all the necessary settings.

The table below shows the different issues to be considered when using frequency converters in SP installations.

Issues to be considered	Explanation
Ramp (up and down): Maximum 3 seconds.	The journal bearings must be lubricated in order to limit wear and overheating of windings.
Use temperature monitoring by Pt sensor.	Overheating of the motor => low insulation resistance => sensitive to voltage peaks.
Reduce peak voltages (max. 800 V peaks).	Never exceed peak voltages of 850 V at motor leads.
For MS and MMS, we recommend that you use motors with 10-20 % extra in given duty point. For MMS, always use motors wound PE2-PA.	Grundfos CUE frequency converter with output filter is a safe solution.
Remember output filter.	Cables act as an amplifier => measure peaks at the motor.
Rise time (dU/dt) must be limited to a maximum of 1000 V/μs. Determined by the equipment in the CUE frequency converter.	Time between switches is an expression of losses, so in the future, we might have to exceed the limit of 1000 V/μs. The solution is not higher insulation of the motor, but filter in the output from the CUE frequency converter.
Minimum 30 Hz. Use a 60 Hz motor for a larger range.	Too low speed => no lubrication of journal bearings.
Size the frequency converter in respect of the current, not the power output.	Can end up with a too small frequency converter.
Size cooling provision for stator tube at duty point with lowest flow rate.	Minimum flow in m/s along the stator housing must be considered.
Ensure that the pump is used within the range of the pump	Focus on discharge pressure and sufficient NPSH, as vibrations will "kill" the motor.

For further information about frequency converter and motors see the CUE and motor documentation available on <https://product-selection.grundfos.com> (Grundfos Product Center).

CIU communication interface units



GRA6118 3908

Fig. 25 Grundfos CIU communication interface unit

For data communication between an SP pump and a main network, a CIU unit together with a CUE frequency converter or an MP 204 motor protector is required.



TMD5 5456 3712 - GRA4 412 3307

Fig. 26 MP 204 motor protector and CUE frequency converter

The communication interface unit (CIU) enables data communication via open and interoperable networks, such as Profibus DP, Modbus RTU, LonWorks, BACnet MS/TP, GSM/GPRS or Grundfos Remote Management (GRM) for complete control of pump systems.

Applications

The range of Grundfos CIU communication interface units offers ease of installation and commissioning as well as user-friendliness.

All units are based on standard functional profiles for an easy integration into the network.

The CIU units enable communication of operating data, such as measured values and setpoints, between pumps and PLCs, SCADA system and building management system.

Benefits

The CIU unit offers these benefits:

- open communication standards
- complete process control
- one concept for Grundfos products
- 24-240 VAC/DC power supply in CIU modules
- simple configuration and easy to install
- prepared for DIN rail or wall mounting.

Fieldbus support for these products is shown in the following table:

CIU unit	Fieldbus protocol	CUE	MP 204	
CIU 100	LonWorks	•	-	
CIU 150	Profibus DP	•	•	* Grundfos Remote Management (GRM) is an easy-to-install low-cost solution for wireless monitoring and management of Grundfos products.
CIU 200	Modbus RTU	•	•	
CIU 250	GSM/GPRS	•	•	
CIU 270/271*	GRM	•	•	
CIU 300	BACnet MS/TP	•	-	

Product numbers

CIU unit	Fieldbus protocol	Product number	Antenna for roof	Antenna for desk
CIU 100	LonWorks	96753735		
CIU 150	Profibus DP	96753081	-	-
CIU 200	Modbus RTU	96753082		
CIU 250	GSM/GPRS	96787106	97631956	97631957
CIU 270	GRM	98176136	97631956	97631957
CIU 271	GRM	96898819	97631956	97631957
CIU 300	BACnet MS/TP	96893769	-	-

For further information about data communication via CIU units and fieldbus protocols, see the CIU documentation available on <https://product-selection.grundfos.com> (Grundfos Product Center).

Grundfos GO

The pump is designed for wireless communication with the Grundfos GO app which communicates with the pump via radio communication.

Note: The radio communication between the pump and Grundfos GO is encrypted to protect against misuse.

The Grundfos GO app is available from Apple App Store and Android market.

The Grundfos GO app must be used in conjunction with one of the following mobile interface devices:

Mobile interface	Product number
Grundfos MI 202	98046376
Grundfos MI 204	98424092
Grundfos MI 301	98046408

The Grundfos GO concept replaces the Grundfos R100 remote control. This means that all products supported by the R100 are supported by Grundfos GO. For function and connection to the pump, see separate installation and operating instructions for the desired type of Grundfos GO setup.

Mobile interface

The available mobile interface devices are described in the following.

MI 202 and MI 204

MI 202 and MI 204 are add-on modules with built-in infrared and radio communication. MI 202 can be used in conjunction with Apple devices with 30-pin connector (iPhone 4, 4S and iPod touch 4G).

MI 204 can be used in conjunction with Apple devices with lightning connector (iPhone 5, 5C, 5S and iPod touch 5G).



Fig. 27 MI 202 and MI 204

Supplied with the product:

- Grundfos MI 202 or 204
- sleeve
- quick guide
- charger cable.

MI 301

MI 301 is a module with built-in infrared and radio communication. MI 301 must be used in conjunction with an Android or iOS-based Smartphone with a Bluetooth connection. MI 301 has a rechargeable Li-ion battery that you must charge separately.



Fig. 28 MI 301

Supplied with the product:

- Grundfos MI 301
- sleeve
- battery charger
- quick guide.

Supported units

Make	Model	Operating system	MI 202	MI 204	MI 301
Apple	iPod touch 4G	iOS 5.0 or later	•	-	•
	iPhone 4, 4S		•	-	•
	iPod touch 5G	iOS 6.0 or later	-	•	•
	iPhone 5, 5C, 5S		-	•	•
HTC	Desire S	Android 2.3.3 or later	-	-	•
	Sensation	Android 2.3.4 or later	-	-	•
	Galaxy S II		-	-	•
Samsung	Galaxy Nexus	Android 4.0 or later	-	-	•
LG	Google Nexus 4	Android 4.2 or later	-	-	•

Note: Similar Android and iOS-based devices may work as well, but Grundfos does not support these devices.

TM05 3887 1612 - TM05 7704 1513

TM05 3887 1612

Motor starters for CSIR/CSCR

Applications

SA-SPM control boxes are used as starting units for 1 x 200-240 V, 50 Hz, 3-wire motors, types MS 402B and MS 4000.



TM06 4358 2015

Fig. 29 Motor starter for MS 402 and MS 4000

Product numbers

	Product number	CS [μF]	CR [μF]
Motor starter - CSIR - 0.37 kW	98582272	65	-
Motor starter - CSIR - 0.55 kW	98582277	98	-
Motor starter - CSIR - 0.75 kW, 50 Hz	98582295	119	-
Motor starter - CSIR - 1.1 kW, 50 Hz	98582296	143	40
Motor starter - CSCR - 1.5 kW	98582381	160	50
Motor starter- CSCR - 2.2 kW	98582401	268	60

PSC motor capacitors

The MS 402 and MS 4000 single phase, 3-wire, PSC motors must be connected to the mains via a motor capacitor that is permanently connected during operation.

Product numbers

Capacitors for MS 402 PSC and MS 4000 PSC		
Capacitor size	Power [kW]	Capacitor
16 iF, 400 V, 50 Hz	0.37	00ID2970
20 μF, 400 V, 50 Hz	0.55	00ID2971
30 μF, 400 V, 50 Hz	0.75	00ID2973
40 μF, 400 V, 50 Hz	1.1	00ID2974

PR 5714 with Pt100 sensor



GrA3187 3607

The PR 5714 with Pt100 sensor offers these features:

- continuous monitoring of the motor temperature
- protection against too high motor temperature.

Protecting the motor against too high motor temperature is the simplest and cheapest way of avoiding that the motor life is reduced. The Pt100 sensor ensures that the operating conditions are not exceeded and indicates when it is time for service of the motor.

Monitoring and protection by means of a Pt100 require the following parts:

- Pt100 sensor
- PR 5714 relay
- cable.

The following temperature limits are preset on delivery:

- 60 °C warning limit
- 75 °C stop limit.

Technical data

Relay type	
PR 5714	
Enclosure class	IP65 (fitted in a control panel)
Ambient temperature	-20 - 60 °C
Relative air humidity	95 % (condensating)
Voltage variation	• 1 x 24-230 VAC ± 10 %, 50-60 Hz • 24-250 VDC ± 20 %
Approvals	UL, DNV
Marking	CE

Product numbers

Cable length [m]	Material	Product number		
		MS 6000	MMS 6 MMS 8000	MMS 10000 MMS 12000
20	N-version	96408953	96494596	96437287
40		96408681	96494597	96437288
60		96408954	96494598	96437289
80		96408955	96494599	96437290
100		96408956	96494610	96437291
20	R-version	96658626	96494596	-
40		96658627	96494597	-
60		96658628	96494598	-
80		96658637	96494599	-
100		96658638	96494610	-

PR 5714 relay for Pt100 and Pt1000	Voltage	Product number
	24-230 VAC, 50/60 Hz / 24-250 VDC	96913234

GrA3186 0407

Pt100 sensor, including cable	Cable length [m]	Product number
	20	96913237
	40	96913253
	60	96913256
	80	96913260
	100	96913263





GrA3190 0407

Staybolt kits for Pt100 in MS 6 and MS 6000	Description	Product number
	Staybolt kit for Pt100/Pt1000. Material: EN 1.4401/ 316.	97550639
	Staybolt kit for Pt100. Material: EN 1.4539/ 90L.	96803373

GrA3191 0407

Insertion probe for MMS 10000 and MMS 12000	Description	Product number
	Insertion probe for Pt100/Pt1000 in MMS 10000 and MMS 12000. Material: EN 1.4401/316 (N-version).	96913215

TM04 3560 4508

Extension kit for sensor cable for Pt100	Description	Product number
	TM00 7885 2296 Extension kit for Pt100 sensor cable. For watertight shrink-joining of the sensor cable. Extra sensor cable must be ordered separately.	96571480
Sensor cable	Description	Product number
	TM00 7882 2296 Drop cable for extension. Mention length when ordering. Maximum recommended length: 350 m.	RM5271
Pt1000 sensor, including cable	Cable length [m]	Product number
	20	96804042
	40	96804044
	60	96804064
	80	96804065
	100	96804067
TM04 3563 4508		
Staybolt kits for Pt1000 in MS 402 and MS 4000	Description	Product number
	TM05 3694 1612 Staybolt kit for Pt1000. Material: EN 1.4401/ 316.	98090278
	Staybolt kit for Pt1000. Material: EN 1.4539/ 904.	98090341

MS motor cables

See the following tables for information about additional motor cables for the MS 402, MS 4000, and MS 6000 range.

Drinking water approval

TML-B cables are drinking water compatible with ACS and KTW approvals.

For more information on sizing motor cables, see [Cable sizing](#) on page 112.

Note: The maximum permissible voltage drop in the submersible motor cable is 3 %.

Note: Always dimension motor cables that are not submerged in the pumped liquid as submersible drop cables.

MS 402 motor cables

TML-B motor cables with EPR outer sheath (ethylene propylene rubber)					
Motor type	Length [m]	Plug steel grade	Cross-section [mm ²]	Plug for drop cable	Product number
MS 402	10	Standard	4 G 1.5	No	00795752
	15				00795753
	20				00795754
	30				00795755
	40				00798890
	50				00795800
	60				98115565
	70				98162757
	80				98162787
	90				98162790
	110				98162804
	120				98163288
MS 402	1.7	Standard	4 G 1.5	Yes	00795712
	2.5				00795739
	5				00798891
	10				00798892

MS 4000 motor cables

TML-B motor cables with EPR outer sheath (ethylene propylene rubber)					
Motor type	Length [m]	Cross-section [mm ²]	Plug for drop cable	Product numbers	
				Plug steel grade N	Plug steel grade R
MS 4000	10	4 G 1.5	Yes	00795620	00795861
	20			00795621	00795862
	30			00795622	00795863
	40			00795623	00795864
	50			00795624	00795865
	60			00795625	00799924
	70			00795626	00799923
MS 4000	10	4 G 1.5	No	00795632	00795873
	20			00795633	00795872
	30			00795634	00795871
	40			00795635	00795870
	50			00795636	00795869
	60			00795637	00799926
	70			00795638	00799925
MS 4000	50	4G 2.5		-	96800534
	80			-	97949530
	130			-	96893810
	150			-	96893838
	170			-	96893844

MS 4000 environmental motor cables

PTFE motor cables with teflon outer sheath				
Motor type	Length [m]	Cross-section [mm ²]	Plug for drop cable	Product numbers
				Plug steel grade R
MS 4000	10	4 G 2.5	No	00795667
	20			00795668
	30			00795669
	40			00795670
	50			00795671
	60			00795672
	70			00795673
	80			00795674
	90			00795675
	100			00795676
	110			96476404
	120			96426909
	200			96432567

MS 6000 motor cables

TML-B motor cables EPR outer sheath (ethylene propylene rubber)					
Motor type	Length [m]	cross-section [mm ²]	Plug for drop cable	Product numbers	
				Plug steel grade N	Plug steel grade R
MS 6000	10	4G 6.0		96164211	96300113
	20			96164212	96300115
	30			96164213	96300117
MS 6000	10	4G 10.0	No	96164215	96300124
	20			96164216	96300126
	30			96164217	96300128
	40			-	96300129
	50			96164218	96300130

Submersible drop cable

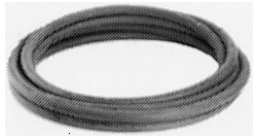
Product	Description	Number of leads and nominal cross-section [mm ²]	Outer cable diameter min./max. [mm]	Weight [kg/m]	Product number
 <p>Suitable for these applications:</p> <ul style="list-style-type: none"> • continuous application in groundwater and potable water (approved for potable-water applications) • connection of electrical equipment, such as submersible motors • installation depths up to 600 metres and average loads. <p>Insulation and sheath of special EPR-based elastomer materials adapted to applications in water.</p> <p>Maximum permissible water temperature: 70 °C. Maximum permissible lead service temperature: 90 °C.</p> <p>Further cable sizes are available on request.</p> <p>TM00 7882 2296</p>		1 x 25	12.5 / 16.5	0.410	00ID4072
		1 x 35	14.0 / 18.5	0.560	00ID4073
		1 x 50	16.5 / 21.0	0.740	00ID4074
		1 x 70	18.5 / 23.5	1.000	00ID4075
		1 x 95	21.0 / 26.5	1.300	00ID4076
		1 x 120	23.5 / 28.5	1.650	00ID4077
		1 x 150	26.0 / 31.5	2.000	00ID4078
		1 x 185	27.5 / 34.5	2.500	00ID4079
		4G1.5	10.5 / 13.5	0.190	00ID4063
		4G2.5	12.5 / 15.5	0.280	00ID4064
		4G4.0	14.5 / 18.0	0.390	00ID4065
		4G6.0	16.5 / 22.0	0.520	00ID4066
		4G10	22.5 / 24.5	0.950	00ID4067
		4G16	26.5 / 28.5	1.400	00ID4068
		4G25	32.0 / 34.0	1.950	00ID4069
		4G35	33.0 / 42.5	2.700	96432949
		4G50	38.0 / 48.5	3.600	96432950
		4G70	43.0 / 54.5	4.900	96432951

Cable clips

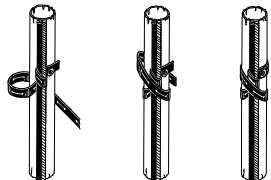

Product	Description	Product number
 <p>TM00 1369 5092</p>	<p>For fastening of cable and straining wire to the riser pipe. The clips must be fitted every 3 metres. One set for approx. 45 m riser pipe.</p> <ul style="list-style-type: none"> • 16 cable buttons. • 7.5 m rubber band. 	00115016



Cable termination kit with plug

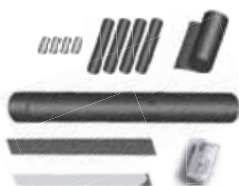

Product	Description	Version	Product number	
			N-version	R-version
 <p>TM00 7883 2296</p>	<p>For watertight joining of motor cable and submersible drop cable in an acrylic tube filled with resin. Used for both single- and multi-core cables during installation of submersible pumps.</p> <p>Note: Only to be used for MS 402 and MS 400 motor cables with two motor plugs</p> <p>24 hours of hardening is required.</p>	For cables up to 4 x 2.5 mm ²	00799901	00799955
		For cables up to 4 x 6 mm ²	00799902	00799918

Cable termination kit, type KM

For instruction on how to make the cable termination between motor cable and drop cable, see the KM quick guide available on <https://product-selection.grundfos.com> (Grundfos Product Center).

Possible cable termination		Content of kit	Motor cable [mm ²]	Drop cable [mm ²]	Number of leads	Product number
Motor cable	Drop cable					
			KM kits with pressed connections:			
			1.5 - 6	1.5 - 6	4	00116251
			6-16	6-16	4	00116252
			10-25	10-25	4	00116255
			KM kits with screw connectors:			
			6-35	6-35	4	96636867
			25-70	25-70	4	96636868

Possible cable termination		Content of kit	Motor cable [mm ²]	Drop cable [mm ²]	Number of leads	Product number
Motor cable	Drop cable					
			KM kits with pressed connections:			
			1.5 - 6	1.5 - 6	4	00116257
			6-16	6-16	4	00116258
			10-50	10-50	4	96637330
			16-70	16-70	4	96637332
			1.5 - 6	1.5 - 6	3	00116253
			10-25	10-25	3	00116254
			10-50	10-50	3	96637318
			16-70	16-70	3	96637331

Possible cable termination		Content of kit	Motor cable [mm ²]	Drop cable [mm ²]	Number of leads	Product number
Motor cable	Drop cable					
			KM kits with pressed connections:			
			10-70	10-70	1	96828296
			32-120	32-120	1	00116256
KM kits with screw connectors:						
		70-240	70-240	1	96637279	

Note: A KM termination kit for single leads only consist of material for one connection. When ordering, keep in mind how many kits are needed for a complete cable termination.

Mastik for flat cables

Product	Description	Product number
	TM05 3693 1612 Mastik for cable termination kit, type KM, for cables with separate earth, 48 pcs.	96871223

Cable termination kit, types M0 to M4

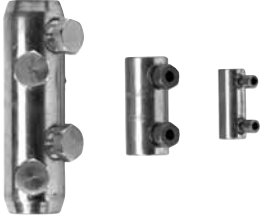
Product	Description	Version			
		Type	Diameter of cable joint [mm]	Outer cable diameter [mm]	Product number
	For watertight joining of motor cable and submersible drop cable. The joint is encapsulated by the glue which is part of the kit.	M0	Ø40	Ø6-15	00ID8903
		M1	Ø46	Ø9-23	00ID8904
		M2	Ø52	Ø17-31	00ID8905
		M3	Ø77	Ø26-44	00ID8906
		M4	Ø97	Ø29-Ø55	91070700
	Accessories for cable kits M0 to M4. Screw connectors only.		Cross-section of leads [mm²]	Number of connectors	Product number
			6-25	4	96626021
			16-95		96626022
			35-185		96626023
	70-240	96626028			

9. Mechanical accessories

Connecting pieces

The tables below show the range of connecting pieces for connection of thread-to-flange and thread-to-thread.

Thread-to-flange (standard flange to EN 1092-1)

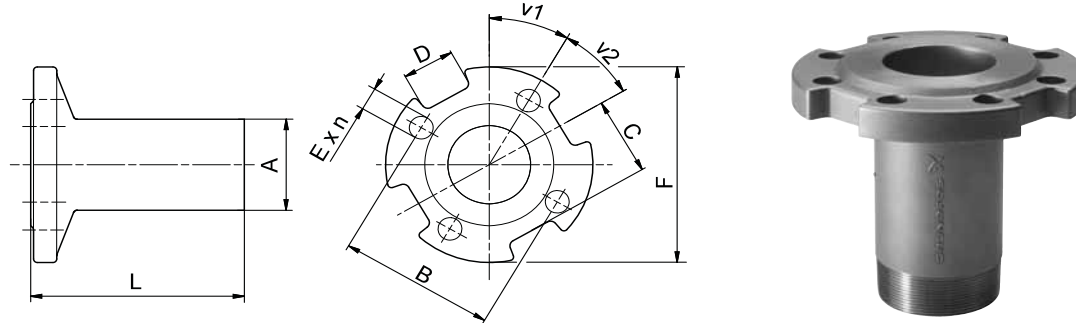
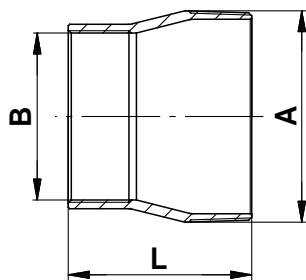

Fig. 30 Dimensional sketch and photo of the connecting piece thread-to-flange

TM01 2396 4508 - GrA2552 3706

Type	Pump outlet	Connecting piece	Thread-to-flange										Product number	
			A	Dimensions [mm]						v1	v2	n	EN 1.4308	EN 1.4517
				B	C	D	E	F	L					
SP 17	Rp 2 1/2	R 2 1/2 → DN 50 PN 16/40	R 2 1/2	125	65	40	Ø19	Ø165	172	60	90	4	00120125	00120911
		R 2 1/2 → DN 65 PN 16/40		145	71	30	Ø19	Ø185	172	22.5	45	8	00120126	00120910
		R 2 1/2 → DN 80 PN 16/40		160	82.5	40	Ø19	Ø200	172	22.5	45	8	00120127	00120909
SP 30	Rp 3	R 3 → DN 65 PN 16/40	R 3	145	71	30	Ø19	Ø185	172	22.5	45	8	00130187	00130920
		R 3 → DN 80 PN 16/40		160	82.5	40	Ø19	Ø200	172	22.5	45	8	00130188	00130921
		R 3 → DN 100 PN 40		190	100	40	Ø23	Ø235	172	22.5	45	8	00130189	00130922
		R 3 → DN 100 PN 16		180	100	40	Ø19	Ø220	172	22.5	45	8	00130210	00130867
SP 46 SP 60	Rp 3	R 3 → DN 65 PN 16/40	R 3	145	71	30	Ø19	Ø185	172	22.5	45	8	00130187	00130920
		R 3 → DN 80 PN 16/40		160	82.5	40	Ø19	Ø200	172	22.5	45	8	00130188	00130921
	R 3 → DN 100 PN 16	180		100	40	Ø19	Ø220	172	22.5	45	8	00130210	00130867	
	R 3 → DN 100 PN 40	190		100	40	Ø23	Ø235	172	22.5	45	8	00130189	00130922	
Rp 4	R 4 → DN 100 PN 16	R 4	180	100	40	Ø19	Ø235	182	22.5	45	8	00140077	00140737	
	R 4 → DN 100 PN 40		190	100	40	Ø23	Ø235	182	22.5	45	8	00140071	00140577	
SP 77 SP 95	Rp 5	R 5 → DN 100 PN 16	R 5	180	82	35	Ø19	Ø220	197	22.5	45	8	00160159	00160657
		R 5 → DN 100 PN 40		190	82	35	Ø23	Ø235	197	22.5	45	8	00160148	00160646
		R 5 → DN 125 PN 16		210	99	37	Ø19	Ø250	197	22.5	45	8	00160157	00160655
		R 5 → DN 125 PN 40		220	99	37	Ø28	Ø270	197	22.5	45	8	00160149	00160647
		R 5 → DN 150 PN 16		240	115	36	Ø23	Ø285	197	22.5	45	8	00160161	00160659
SP 125 SP 160 SP 215	Rp 6	R 5 → DN 150 PN 40	R 6	250	115	36	Ø28	Ø300	197	22.5	45	8	00160150	00160648
		R 6 → DN 125 PN 16		210	99	36	Ø19	Ø250	197	22.5	45	8	00170170	00170694
		R 6 → DN 125 PN 40		220	99	36	Ø28	Ø270	197	22.5	45	8	00170159	00170596
		R 6 → DN 150 PN 16		240	114	36	Ø23	Ø285	197	22.5	45	8	98518437	98518487
		R 6 → DN 150 PN 40		250	114	36	Ø28	Ø300	197	22.5	45	8	00170160	00170597
		R 6 → DN 200 PN 16		295	134	36	Ø23	Ø340	197	15	30	12	00170161	00170598
R 6 → DN 200 PN 40	320	151	36	Ø31	Ø375	200	15	30	12	00170162	00170599			

Thread-to-thread



TM01 2397 1698 - GrA2555 3706

Fig. 31 Dimensional sketch and photo of the connecting piece thread-to-thread

Type	Pump outlet	Connecting piece	Dimensions			Product number		
			Thread-to-thread		L [mm]	EN 1.4301	EN 1.4401	EN 1.4539
			A	B				
SP 77 SP 95	Rp 5	R 5 → Rp 4	R 5	Rp 4	121	00190063	00190585	96917293
		R 5 → Rp 6	R 5	Rp 6	150	00190069	00190591	96917296
SP 125 SP 160 SP 215	5" NPT	5" NPT → 4" NPT	5" NPT	4" NPT	121	00190064	00190586	-
		5" NPT → 6" NPT	5" NPT	6" NPT	150	00190070	00190592	-
SP 125 SP 160 SP 215	Rp 6	R 6 → Rp 5	R 6	Rp 5	150	00200130	00200640	00200971
	6" NPT	6" NPT → 5" NPT	6" NPT	5" NPT	150	00200135	00200645	-

Zinc anodes

Applications

Cathodic protection by means of zinc can be used for corrosion protection of SP pumps in chloride-containing liquids, such as brackish water and seawater.

Sacrificial anodes are placed on the outside of the pump and motor as protection against corrosion. See fig. 32.

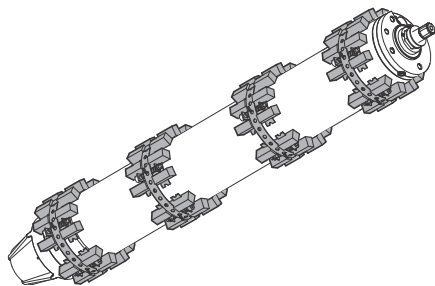

TM05 0537 1211

Fig. 32 Submersible motor fitted with anode strings

The number of anodes required depends on the pump and motor in question.

Please contact Grundfos for further details.

Flow sleeves

Grundfos offers a complete range of stainless-steel flow sleeves for both vertical and horizontal operation. We recommend flow sleeves for all applications in which motor cooling is insufficient. The result is a general extension of motor life. Flow sleeves are to be fitted in these cases:

- If the submersible pump is exposed to high thermal load such as current unbalance, dry running, overload, high ambient temperature and bad cooling conditions.
- If aggressive liquids are pumped, since corrosion is doubled for every 10 °C the temperature rises.
- If sedimentation or deposits occur around and/or on the motor.

See example

Note: More information about flow sleeves is available on request.



TM01 0751 2197 - TM01 0750 2197

Fig. 33 Flow sleeves

Example of calculated flow sleeve

The flow sleeve is fitted to the submersible motor so that the liquid passes close by the motor on its way towards the pump suction interconnector, thus ensuring optimum cooling of the motor. See fig. 34.

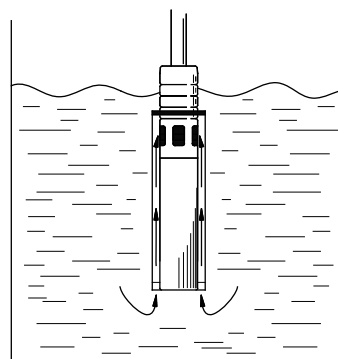

TM01 0509 1297

Fig. 34 Flow sleeve function

The flow sleeve is designed so that the flow velocity past the motor is minimum 0.5 m/s and maximum 3 m/s to ensure optimum pump operating conditions. Use this formula to calculate flow velocity:

$$V = \frac{Q \times 353}{D^2 - d^2} \text{ [m/s]}$$

Q	m ³ /h	Flow rate
D	mm	Sleeve diameter
d	mm	Pump diameter

10. Energy consumption

Energy consumption of submersible pumps

The percentage distribution of service life costs of a submersible pump for water supply is as follows:

- 5 % initial costs (pump)
- 85 % operating costs/energy consumption
- 10 % maintenance costs.

It is obvious that the highest savings can be achieved within energy consumption!

You can calculate the annual energy consumption, E, of a submersible pump as follows:

$$E = c \times h \times P1 \text{ (EUR)}$$

c = specific energy price (EUR/kWh)

h = operating hours/year (hours)

P1 = power input of the submersible pump (kW).

Example: Calculation of the annual energy consumption of the submersible pump, type SP 125-3. SP 125-3 with MS 6000, 30 kW, 3 x 400 V, 50 Hz.

Duty point

Flow rate: Q = 120 m³/h

Total head: H = 63 m

Specific energy price: c = EUR 0.1/kWh
(consisting of day and night rate)

Operating hours/year: h = 3200.

$$P1 = \frac{Q \times H \times \rho}{367 \times \eta_{\text{pump}} \times \eta_{\text{motor}}} \text{ in kW}$$

Q = m³/h

H = m

Density ρ = kg/dm³ (assumed 1)

369 = conversion factor

η_{pump} = not to be confused with the stage efficiency curve

η_{motor} = example 84.5 %, in equation 0.845.

By showing the P2/Q curve, we make it easier for you to calculate the energy consumption.

$$P1 = \frac{P2}{\eta_{\text{motor}}}$$

P2 = 26 kW. The power requirement of SP 125-3 pump at 120 m³/h, from curve P2/Q on page 74.

Calculation of motor efficiency at duty point

As standard, the SP 125-3 is fitted with a 30 kW MS 6000 motor.

At duty point (Q = 120 m³/h), the pump requires 26 kW, thus: a motor load of 87 % (26 kW / 30 kW) and a power reserve of 13 %.

From the table on page 89, the motor efficiency can be read as:

- 85 % at a load of 75 % (η_{75 %})
- 84 % at a load of 100 % (η_{100 %})

The interpolated value in this example is η_{motor} = 84.5 %, η_{motor} = 0.845.

$$P1 = \frac{26}{0.845} = 30.77 \text{ kW}$$

E = 0.1 EUR/kWh x 3200 h x 30.77 kW.

The annual energy costs amount to EUR 9,846.

If we compare the energy costs of this energy-efficient Grundfos submersible pump with a submersible pump, type SP 120-4, from 1995, (Q = 110 to 120 m³/h; H = 63 to 58 m; η_{motor} = 82 %), we see that at the same annual total flow of 384,000 m³ and the same current price of 0.1 EUR/kWh, the annual energy consumption of the old pump amounts to EUR 12,777.

Wear and deposits on the motor and the pump were not taken into account.

The pay-off time, A (months), is calculated as follows:

$$A = \frac{\text{Purchase price of energy - efficient pump}}{\text{Energy savings/year}} \times 12$$

The purchase price of the energy-efficient pump is EUR 4,090.

$$A = \frac{4090}{(\text{EUR } 12,777 - \text{EUR } 9,846)} \times 12 = 16.7 \text{ months}$$

The payoff time is 16.7 months.

Note: The complete system must be sized for energy efficiency (cable/discharge pipes).

Cable sizing

In order to obtain an economical duty of the pump, the voltage drop should be low.

Today, large water works already size cables for a maximum voltage drop of 1 %.

The hydraulic resistance in the discharge pipe must be as low as possible.

11. Cable sizing

Cables

Grundfos offers submersible drop cables for all applications: 4-core cable, single leads.

Cables for Grundfos 4" submersible motors are available with or without plugs. The submersible drop cable is chosen according to application and type of installation.

Standard version:

Maximum liquid temperature 70 °C, for short periods up to 90 °C.

Tables indicating cable dimension in borehole

The tables indicate the maximum length of drop cables in metres from motor starter to pump at direct-on-line starting at different cable dimensions.

If star-delta starting is used, the current will be reduced by $\sqrt{3}$ ($I \times 0.58$), meaning that the cable length may be $\sqrt{3}$ longer ($L \times 1.73$) than indicated in the tables.

If, for example, the operating current is 10 % lower than the full-load current, the cable may be 10 % longer than indicated in the tables.

The calculation of the cable length is based on a maximum voltage drop of 1 % to 3 % of the rated voltage and a water temperature of maximum 30 °C.

In order to minimise operating losses, the cable cross-section may be increased compared to what is indicated in the tables. This is only economical if the borehole provides the necessary space, and if the operational time of the pump is long, especially if the operating voltage is below the rated voltage.

The table values are calculated on the basis of the formula:

Maximum cable length of a single-phase submersible pump:

$$L = \frac{U \times \Delta U}{I \times 2 \times 100 \times (\cos \varphi \times \frac{\rho}{q} + \sin \varphi \times X_L)} \text{ [m]}$$

Maximum cable length of a three-phase submersible pump:

$$L = \frac{U \times \Delta U}{I \times 1.73 \times 100 \times (\cos \varphi \times \frac{\rho}{q} + \sin \varphi \times X_L)} \text{ [m]}$$

Formula designations

U = Rated voltage [V]

ΔU = Voltage drop [%]

I = Rated current of the motor [A]

$\cos \varphi$ = Power factor

ρ = Specific resistance: 0.025 [$\Omega \text{ mm}^2$]

q = Cross-section of submersible drop cable [mm^2]

$\sin \varphi = \sqrt{1 - \cos^2 \varphi}$

X_L = Inductive resistance: 0.078×10^{-3} [Ω/m].

Example

Motor size:	30 kW, MMS 8000
Starting method:	Direct on line
Rated voltage (U):	3 x 400 V, 50 Hz
Voltage drop (ΔU):	3 %
Rated current (I):	64.0 A
Power factor ($\cos \varphi$):	0.85
Specific resistance (ρ):	0.025
Cross-section (q):	25 mm^2
$\sin \varphi$:	0.54
Inductive resistance (X_L):	0.078×10^{-3} [Ω/m]

$$L = \frac{400 \times 3}{64.0 \times 1.73 \times 100 \times (0.85 \times \frac{0.025}{25} + 0.54 \times 0.078 \times 10^{-3})}$$

$$L = 120 \text{ m.}$$

Cable dimensions at 3 x 400 V, 50 Hz, DOL

Voltage drop: 3 %

Motor	kW	I _n [A]	Cos φ 100 %	Dimensions [mm ²]																
				1.5	2.5	4	6	10	16	25	35	50	70	95	120	150	185	240	300	
4"	0.37	1.4	0.64	462	767															
4"	0.55	2.2	0.64	294	488	777														
4"	0.75	2.3	0.72	250	416	662	987													
4"	1.1	3.4	0.72	169	281	448	668													
4"	1.5	4.2	0.75	132	219	348	520	857												
4"	2.2	5.5	0.82	92	153	244	364	602	951											
4"	3	7.85	0.77	69	114	182	271	447	705											
4"	4	9.6	0.8	54	90	143	214	353	557	853										
4"	5.5	13	0.81	39	66	104	156	258	407	624	855									
4"	7.5	18.8	0.78	28	47	75	112	185	291	445	609	841								
6"	4	9.2	0.82	55	91	146	218	359	566	867										
6"	5.5	13.6	0.77	40	66	105	157	258	407	622	850									
6"	7.5	17.6	0.8	29	49	78	117	193	304	465	637	882								
6"	9.2	21.8	0.81	23	39	62	93	154	243	372	510	706	950							
6"	11	24.8	0.83		34	53	80	132	209	320	440	610	823							
6"	13	30	0.81		28	45	68	112	176	270	370	513	690	893						
6"	15	34	0.82			39	59	97	154	236	324	449	604	783	947					
6"	18.5	42	0.81				48	80	126	193	265	366	493	638	770	914				
6"	22	48	0.84				41	67	107	164	225	313	422	549	665	793	927			
6"	26	57	0.84					57	90	138	189	263	355	462	560	667	781	937		
6"	30	66.5	0.83					49	78	119	164	227	307	398	482	574	670	803	926	
6"	37	85.5	0.79						63	97	133	183	246	317	382	452	525	624	714	
8"	22	48	0.84				41	67	107	164	225	313	422	549	665	793	927			
8"	26	56.5	0.85					57	90	138	189	263	356	464	563	672	787	947		
8"	30	64	0.85					50	79	122	167	233	314	409	497	593	695	836	968	
8"	37	78.5	0.85						65	99	136	190	256	334	405	483	567	682	789	
8"	45	96.5	0.82						54	83	114	158	213	276	334	396	462	553	636	
8"	55	114	0.85							68	94	131	177	230	279	333	390	469	544	
8"	63	132	0.83								83	115	155	201	243	289	338	404	466	
8"	75	152	0.86								70	97	132	171	208	249	292	353	409	
8"	92	186	0.86									79	107	140	170	204	239	288	335	
8"	110	224	0.87										89	116	141	169	198	240	279	
10"	75	156	0.84								69	96	130	169	205	244	285	343	396	
10"	92	194	0.82									79	106	137	166	197	230	275	316	
10"	110	228	0.84										89	116	140	167	195	234	271	
10"	132	270	0.84											98	118	141	165	198	229	
10"	147	315	0.81												103	122	142	169	194	
10"	170	365	0.81													105	122	146	168	
10"	190	425	0.79														106	125	144	
12"	147	305	0.83												105	125	146	175	202	
12"	170	345	0.85												92	110	129	155	180	
12"	190	390	0.84													98	114	137	158	
12"	220	445	0.85														100	120	139	
12"	250	505	0.85															106	123	
Max. current for cable [A]*				23	30	41	53	74	99	131	162	202	250	301	352	404	461	547	633	

* At particularly favourable heat dissipation conditions. Maximum cable length in metres from motor starter to pump.
 For motors with star-delta starting, the cable length can be calculated by multiplying the relevant cable length from the above table by $\sqrt{3}$.

Sizing of cable

Calculation of cable cross-section

Formula designations

U = Rated voltage [V]

ΔU = Voltage drop [%]

I = Rated current of the motor [A]

$\cos \varphi$ = Power factor

$\rho = 1/\chi$

Materials of cable:

Copper: $\chi = 40 \text{ m}/\Omega \times \text{mm}^2$

Aluminium: $\chi = 35 \text{ m}/\Omega \times \text{mm}^2$

q = Cross-section [mm^2]

$\sin \varphi = \sqrt{1 - \cos^2 \varphi}$

$X_L = \text{Inductive resistance } 0.078 \times 10^{-3} [\Omega/\text{m}]$

L = Length of cable [m]

$\Delta p = \text{Power loss [W]}$.

For calculation of the cross-section of the submersible drop cable, use this formula:

Direct on line

$$q = \frac{I \times 1.73 \times 100 \times L \times \rho \times \cos \varphi}{U \times \Delta U - (I \times 1.73 \times 100 \times L \times X_L \times \sin \varphi)}$$

Star-delta

$$q = \frac{I \times 100 \times L \times \rho \times \cos \varphi}{U \times \Delta U - (I \times 100 \times L \times X_L \times \sin \varphi)}$$

You can read the values of the rated current (I) and the power factor ($\cos \varphi$) in the tables on pages 89 to 93.

Calculation of the power loss

For calculation of the power loss in the submersible drop cable, use this formula:

$$\Delta p = \frac{3 \times L \times \rho \times I^2}{q}$$

Example

Motor size:	45 kW, MMS 8000
Voltage:	3 x 400 V, 50 Hz
Starting method:	Direct on line
Rated current (I_n):	96.5 A
Required cable length (L):	200 m
Water temperature:	30 °C.

Cable selection

Choice A: 3 x 150 mm^2 .

Choice B: 3 x 185 mm^2 .

Calculation of power loss

Choice A

$$\Delta p_A = \frac{3 \times L \times \rho \times I^2}{q}$$

$$\Delta p_A = \frac{3 \times 200 \times 0.02 \times 96.5^2}{150}$$

$\Delta p_A = 745 \text{ W}$.

Choice B

$$\Delta p_B = \frac{3 \times 200 \times 0.02 \times 96.5^2}{185}$$

$\Delta p_B = 604 \text{ W}$.

Savings

Operating hours/year: h = 4000.

Annual saving (A):

$$A = (\Delta p_A - \Delta p_B) \times h = (745 \text{ W} - 604 \text{ W}) \times 4000 = 564,000 \text{ Wh} = 564 \text{ kWh}.$$

By choosing the cable size 3 x 185 mm^2 instead of 3 x 150 mm^2 , you achieve an annual saving of 564 kWh.

Operating time: 10 years.

Saving after 10 years (A_{10}):

$$A_{10} = A \times 10 = 564 \times 10 = 5640 \text{ kWh}.$$

You must calculate the saved amount in the local currency.

12. Table of head losses

Head losses in ordinary water pipes

Upper figures indicate the velocity of water in m/sec.

Lower figures indicate head loss in metres per 100 metres of straight pipes.

Quantity of water			Head losses in ordinary water pipes														
m ³ /h	Litres/min.	Litres/sec.	Nominal pipe diameter in inches and internal diameter in [mm]														
			1/2"	3/4"	1"	1 1/4"	1 1/2"	2"	2 1/2"	3"	3 1/2"	4"	5"	6"			
0.6	10	0.16	0.855 9.910	0.470 2.407	0.292 0.784												
0.9	15	0.25	1.282 20.11	0.705 4.862	0.438 1.570	0.249 0.416											
1.2	20	0.33	1.710 33.53	0.940 8.035	0.584 2.588	0.331 0.677	0.249 0.346										
1.5	25	0.42	2.138 49.93	1.174 11.91	0.730 3.834	0.415 1.004	0.312 0.510										
1.8	30	0.50	2.565 69.34	1.409 16.50	0.876 5.277	0.498 1.379	0.374 0.700	0.231 0.223									
2.1	35	0.58	2.993 91.54	1.644 21.75	1.022 6.949	0.581 1.811	0.436 0.914	0.269 0.291									
2.4	40	0.67		1.879 27.66	1.168 8.820	0.664 2.290	0.499 1.160	0.308 0.368									
3.0	50	0.83		2.349 41.40	1.460 13.14	0.830 3.403	0.623 1.719	0.385 0.544	0.229 0.159								
3.6	60	1.00		2.819 57.74	1.751 18.28	0.996 4.718	0.748 2.375	0.462 0.751	0.275 0.218								
4.2	70	1.12		3.288 76.49	2.043 24.18	1.162 6.231	0.873 3.132	0.539 0.988	0.321 0.287	0.231 0.131							
4.8	80	1.33		2.335 30.87	1.328 7.940	0.997 3.988	0.616 3.988	0.367 1.254	0.263 0.363	0.184							
5.4	90	1.50		2.627 38.30	1.494 9.828	1.122 4.927	0.693 4.927	0.413 1.551	0.269 0.203								
6.0	100	1.67		2.919 46.49	1.660 11.90	1.247 5.972	0.770 1.875	0.459 0.542	0.329 0.244	0.248 0.124							
7.5	125	2.08		3.649 70.41	2.075 17.93	1.558 8.967	0.962 2.802	0.574 0.809	0.412 0.365	0.310 0.185	0.241 0.101						
9.0	150	2.50		2.490 25.11	1.870 12.53	1.154 3.903	0.668 1.124	0.494 0.506	0.372 0.256	0.289 0.140							
10.5	175	2.92		2.904 33.32	2.182 16.66	1.347 5.179	0.803 1.488	0.576 0.670	0.434 0.338	0.337 0.184							
12	200	3.33		3.319 42.75	2.493 17.36	1.539 6.624	0.918 1.901	0.659 0.855	0.496 0.431	0.385 0.234	0.251 0.084						
15	250	4.17		4.149 64.86	3.117 32.32	1.924 10.03	1.147 2.860	0.823 1.282	0.620 0.646	0.481 0.350	0.314 0.126						
18	300	5.00			3.740 45.52	2.309 14.04	1.377 4.009	0.988 1.792	0.744 0.903	0.577 0.488	0.377 0.175	0.263 0.074					
24	400	6.67			4.987 78.17	3.078 24.04	1.836 6.828	1.317 3.053	0.992 1.530	0.770 0.829	0.502 0.294	0.351 0.124					
30	500	8.33				3.848 45.52	2.295 14.04	1.647 4.622	1.240 2.315	0.962 1.254	0.628 0.445	0.439 0.187					
36	600	10.0				4.618 51.84	2.753 14.62	1.976 6.505	1.488 3.261	1.155 1.757	0.753 0.623	0.526 0.260					
42	700	11.7				3.212 19.52	2.306 8.693	1.736 4.356	1.347 2.345	1.347 2.345	0.879 0.831	0.614 0.347					
48	800	13.3					3.671 25.20	2.635 11.18	1.984 5.582	1.540 3.009	1.005 1.066	0.702 0.445					
54	900	15.0					4.130 31.51	2.964 13.97	2.232 6.983	1.732 3.762	1.130 1.328	0.790 0.555					
60	1000	16.7					4.589 38.43	3.294 17.06	2.480 8.521	1.925 4.595	1.256 1.616	0.877 0.674					
75	1250	20.8						4.117 26.10	3.100 13.00	2.406 7.010	1.570 2.458	1.097 1.027					
90	1500	25.0						4.941 36.97	3.720 18.42	2.887 9.892	1.883 3.468	1.316 1.444					
105	1750	29.2						4.340 24.76	3.368 13.30	2.197 4.665	1.535 1.934						
120	2000	33.3						4.960 31.94	3.850 17.16	2.511 5.995	1.754 2.496						
150	2500	41.7							4.812 26.26	3.139 9.216	2.193 3.807						
180	3000	50.0								3.767 13.05	2.632 5.417						
240	4000	66.7									5.023 22.72	3.509 8.926					
300	5000	83.3										4.386 14.42					
		90° bends, slide valves	1.0	1.0	1.1	1.2	1.3	1.4	1.5	1.6	1.6	1.7	2.0	2.5			
		T-pieces, non-return valves	4.0	4.0	4.0	5.0	5.0	5.0	6.0	6.0	6.0	7.0	8.0	9.0			

The table is calculated in accordance with H. Lang's new formula $a = 0.02$ and for a water temperature of 10 °C. The head loss in bends, slide valves, T-pieces and non-return valves is equivalent to the metres of straight pipes stated in the last two lines of the table. To find the head loss in foot valves, multiply the loss in T-pieces by two.

Head losses in plastic pipes

Upper figures indicate the velocity of water in m/sec.

Lower figures indicate head loss in metres per 100 metres of straight pipes.

Quantity of water			PELM/PEH PN 10											
m ³ /h	Litres/min.	Litres/sec.	PELM				PEH							
			25	32	40	50	63	75	90	110	125	140	160	180
			20.4	26.2	32.6	40.8	51.4	61.4	73.6	90.0	102.2	114.6	130.8	147.2
0.6	10	0.16	0.49 1.8	0.30 0.66	0.19 0.27	0.12 0.085								
0.9	15	0.25	0.76 4.0	0.46 1.14	0.3 0.6	0.19 0.18	0.12 0.63							
1.2	20	0.33	1.0 6.4	0.61 2.2	0.39 0.9	0.25 0.28	0.16 0.11							
1.5	25	0.42	1.3 10.0	0.78 3.5	0.5 1.4	0.32 0.43	0.2 0.17	0.14 0.074						
1.8	30	0.50	1.53 13.0	0.93 4.6	0.6 1.9	0.38 0.57	0.24 0.22	0.17 0.092						
2.1	35	0.58	1.77 16.0	1.08 6.0	0.69 2.0	0.44 0.70	0.28 0.27	0.2 0.12						
2.4	40	0.67	2.05 22.0	1.24 7.5	0.80 3.3	0.51 0.93	0.32 0.35	0.23 0.16	0.16 0.063					
3.0	50	0.83	2.54 37.0	1.54 11.0	0.99 4.8	0.63 1.40	0.4 0.50	0.28 0.22	0.2 0.09					
3.6	60	1.00	3.06 43.0	1.85 15.0	1.2 6.5	0.76 1.90	0.48 0.70	0.34 0.32	0.24 0.13	0.16 0.050				
4.2	70	1.12	3.43 50.0	2.08 18.0	1.34 8.0	0.86 2.50	0.54 0.83	0.38 0.38	0.26 0.17	0.18 0.068				
4.8	80	1.33		2.47 25.0	1.59 10.5	1.02 3.00	0.64 1.20	0.45 0.50	0.31 0.22	0.2 0.084				
5.4	90	1.50		2.78 30.0	1.8 12.0	1.15 3.50	0.72 1.30	0.51 0.57	0.35 0.26	0.24 0.092	0.18 0.05			
6.0	100	1.67		3.1 39.0	2.0 16.0	1.28 4.6	0.8 1.80	0.56 0.73	0.39 0.30	0.26 0.12	0.2 0.07			
7.5	125	2.08		3.86 50.0	2.49 24.0	1.59 6.6	1.00 2.50	0.70 1.10	0.49 0.50	0.33 0.18	0.25 0.10	0.20 0.055		
9.0	150	2.50		3.00 33.0	1.91 8.6	1.20 3.5	0.84 1.40	0.59 0.63	0.39 0.24	0.30 0.13	0.24 0.075			
10.5	175	2.92		3.5 38.0	2.23 11.0	1.41 4.3	0.99 1.80	0.69 0.78	0.46 0.30	0.36 0.18	0.28 0.09			
12	200	3.33		3.99 50.0	2.55 14.0	1.60 5.5	1.12 2.40	0.78 1.0	0.52 0.40	0.41 0.22	0.32 0.12	0.25 0.065		
15	250	4.17			3.19 21.0	2.01 8.0	1.41 3.70	0.98 1.50	0.66 0.57	0.51 0.34	0.40 0.18	0.31 0.105	0.25 0.06	0.25 0.09
18	300	5.00			3.82 28.0	2.41 10.5	1.69 4.60	1.18 1.95	0.78 0.77	0.61 0.45	0.48 0.25	0.37 0.13	0.29 0.085	0.26 0.085
24	400	6.67				3.21 19.0	2.25 8.0	1.57 3.60	1.05 1.40	0.81 0.78	0.65 0.44	0.50 0.23	0.39 0.15	0.39 0.15
30	500	8.33				4.01 28.0	2.81 11.5	1.96 5.0	1.31 2.0	1.02 1.20	0.81 0.63	0.62 0.33	0.49 0.21	0.49 0.21
36	600	10.0				4.82 37.0	3.38 15.0	2.35 6.6	1.57 2.60	1.22 1.50	0.97 0.82	0.74 0.45	0.59 0.28	0.59 0.28
42	700	11.7				5.64 47.0	3.95 24.0	2.75 8.0	1.84 3.50	1.43 1.90	1.13 1.10	0.87 0.60	0.69 0.40	0.69 0.40
48	800	13.3					4.49 26.0	3.13 11.0	2.09 4.5	1.62 2.60	1.29 1.40	0.99 0.81	0.78 0.48	0.78 0.48
54	900	15.0					5.07 33.0	3.53 13.5	2.36 5.5	1.83 3.20	1.45 1.70	1.12 0.95	0.08 0.58	0.08 0.58
60	1000	16.7					5.64 40.0	3.93 16.0	2.63 6.7	2.04 3.90	1.62 2.2	1.24 1.2	0.96 0.75	0.96 0.75
75	1250	20.8						4.89 25.0	3.27 9.0	2.54 5.0	2.02 3.0	1.55 1.6	1.22 0.95	1.22 0.95
90	1500	25.0						5.88 33.0	3.93 13.0	3.05 8.0	2.42 4.1	1.86 2.3	1.47 1.40	1.47 1.40
105	1750	29.2						6.86 44.0	4.59 17.5	3.56 9.7	2.83 5.7	2.17 3.2	1.72 1.9	1.72 1.9
120	2000	33.3							5.23 23.0	4.06 13.0	3.23 7.0	2.48 4.0	1.96 2.4	1.96 2.4
150	2500	41.7							6.55 34.0	5.08 18.0	4.04 10.5	3.10 6.0	2.45 3.5	2.45 3.5
180	3000	50.0							7.86 45.0	6.1 27.0	4.85 14.0	3.72 7.6	2.94 4.4	2.94 4.4
240	4000	66.7								8.13 43.0	6.47 24.0	4.96 13.0	3.92 7.5	3.92 7.5
300	5000	83.3									8.08 33.0	6.2 18.0	4.89 11.0	4.89 11.0

The table is based on a nomogram.

Roughness: K = 0.01 mm.

Water temperature: t = 10 °C.

13. Grundfos Product Center

Online search and sizing tool to help you make the right choice.

<http://product-selection.grundfos.com>



"SIZING" enables you to size a pump based on entered data and selection choices.

"REPLACEMENT" enables you to find a replacement product. Search results will include information on the following:

- the lowest purchase price
- the lowest energy consumption
- the lowest total life cycle cost.

The screenshot shows the Grundfos Product Center website. At the top, there is a navigation bar with the logo and 'PRODUCT CENTER'. Below it, a menu includes 'HOME', 'FIND PRODUCT', 'COMPARE', 'YOUR PROJECTS', 'SAVED ITEMS', and 'HELP'. The main content area features a search bar with the placeholder text 'Input product number or a whole or partial product name' and a 'SEARCH' button. Below the search bar are four main navigation buttons: 'SIZING' (with a subtext 'Enter pump sizing'), 'CATALOGUE' (with a subtext 'Products and services'), 'REPLACEMENT' (with a subtext 'Replace an old pump with a new'), and 'LIQUIDS' (with a subtext 'Find pump by liquid'). The 'QUICK SIZING' section is visible, containing 'Enter duty point' fields for Flow (Q)* and Head (H)*, and 'Select what to size by' radio buttons for 'Size by application', 'Size by pump design', and 'Size by pump family'. A 'START SIZING' button is also present. At the bottom of the quick sizing section, there are 'ADVANCED SIZING' options: 'Advanced sizing by application' and 'Guided selection'.

"CATALOGUE" gives you access to the Grundfos product catalogue.

"LIQUIDS" enables you to find pumps designed for aggressive, flammable or other special liquids.

All the information you need in one place

Performance curves, technical specifications, pictures, dimensional drawings, motor curves, wiring diagrams, spare parts, service kits, 3D drawings, documents, system parts. The Product Center displays any recent and saved items - including complete projects - right on the main page.

Downloads

On the product pages, you can download installation and operating instructions, data booklets, service instructions, etc. in PDF format.

Subject to alterations.

be think innovate

V7023747 0715

ECM: 1162086

GRUNDFOS A/S
DK-8850 Bjerringbro . Denmark
Telephone: +45 87 50 14 00
www.grundfos.com

GRUNDFOS 

The name Grundfos, the Grundfos logo, and be think innovate are registered trademarks owned by Grundfos Holding A/S or Grundfos A/S, Denmark. All rights reserved worldwide. © Copyright Grundfos Holding A/S