

SEG range 0.9 – 4.0 kW



Tough, versatile pumps for domestic sewage transfer

In areas with no sewer systems, or areas where gravitation systems are unsuitable, pressurised systems are the perfect choice for transfer of effluent and domestic sewage to the public sewer or sewage treatment plant. Grundfos offers the perfect pump for such systems, facilitating the use of smaller pressure pipes for minimal investment costs. The Grundfos grinder pump range (SEG) provides many customer benefits, combining cost-effectiveness with maximum protection of the environment.



Unique user benefits

- **Highly efficient and very dependable**
- **Improved discharge pressure**
- **New, efficient grinder system**
- **Integrated SmartTrim system for adjustment of impeller clearance**
- **Polyurethane-sealed cable plug ensures a completely watertight unit**

The Grundfos grinder pumps (SEG) are specifically designed for pumping untreated sewage in small communities or sparsely populated areas.

A newly developed cartridge shaft seal system, together with the polyurethane-sealed cable plug system, prevents liquid from penetrating into the motor. High discharge pressure enables transfer of sewage over longer distances.

The new and efficient grinder system with easily replaceable parts reduces downtime and facilitates quick and easy maintenance.

The unique SmartTrim impeller clearance adjustment system ensures optimum performance at all times.



Installation options

Grundfos SEG pumps can be installed on two different types of auto-coupling systems. The auto-coupling systems enable automatic connection or disconnection of the pump from outside the pit. Alternatively, the SEG pumps are available as free-standing pumps.

Submerged installation on auto-coupling with guide rails

When the SEG pump is installed on an auto-coupling system where the base is fixed to the bottom of the pump pit, the pump is lowered into the pit on a dual guide rail system. The pump automatically connects to the base unit in a tilted position in order to evacuate possible air in the pump housing and to prevent clogging or jamming.



Submerged installation on hookup auto-coupling

When the SEG pump is installed on a hookup auto-coupling system, the base is fixed on a crossbar above the liquid level in the pit. The pump is lowered into the pit with the discharge pipe and the counter part of the coupling. The pump will be fixed in a tilted position when it is connected to the base.

With both auto-coupling systems, the weight of the pump in combination with the Grundfos SmartSeal system* will prevent leakage when the pump is operating.

*Further information please see page 7.

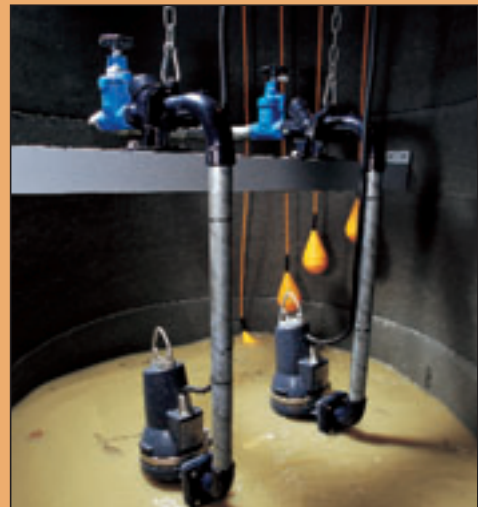

Submerged free-standing installation

For non-permanent free-standing installation or as a utility pump, additional feet extensions can be fitted to ensure sufficient free suction and to prevent clogging or jamming. The pump can be equipped with a rigid discharge pipe or a flexible hose as required.

Note: To prevent sedimentation of sludge in connection with intermittent operation, we recommend a stop level corresponding to the top of the pump housing.



Tough and reliable pumps...

The Grundfos submersible sewage grinder pumps are designed to reduce energy consumption and to keep downtime costs at a minimum. Maintaining peak performance throughout the entire lifetime of the system is a key issue:



Watertight cable connection

The hermetically sealed polyurethane-filled, stainless steel cable plug connection ensures that no liquid will penetrate through the cable into the motor.

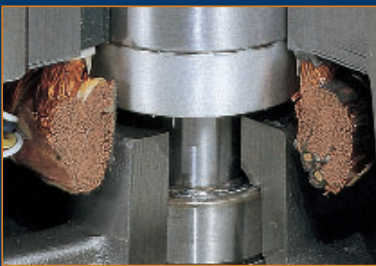

Short motor shaft

Compact construction with short shaft outside bearings, ensures less stress on bearings and, consequently, longer lifetime.



Shaft seal

Double mechanical cartridge shaft seal system provides longer operating time and less downtime. Easy to replace in the field without use of special tools.



Cast iron flange and feet

Feet on the pump housing provide protection of the grinder system. Additional feet are provided for free-standing installation in order to facilitate suction. DN 40 PN 10 flange fits both DN 40 and DN 50 connections.



Stainless steel clamp

Unique clamp system enables quick and easy dismantling of pump and motor unit. No tools required. Enables 180° rotation of motor housing.



– with many unique features



Specially designed lifting handle

Ensures correct lifting regardless of installation or motor positioning.



Motor protection

Built-in thermal switches in the motor windings provide protection against overheating. Ensures long lifetime.



The heavy-duty ball bearings

Heavy-duty, maintenance-free ball bearings are greased for life. Single-row ball bearings in pumps with 0.9 kW to 1.5 kW motors. Pumps with 2.6 kW to 4.0 kW motors feature double-row, angular contact ball bearings as the lower bearing.



New, efficient grinder system

Patented grinder system ensures extremely high efficiency and reliable operation. Quick and easy dismantling for replacement of wear parts. No special tools are required.



SmartTrim impeller adjustment

Patented SmartTrim system enables quick and easy impeller clearance adjustment in order to maintain peak performance. Can be done without dismantling the pump. No special tools are required.



Performance overview and type key

Performance overview

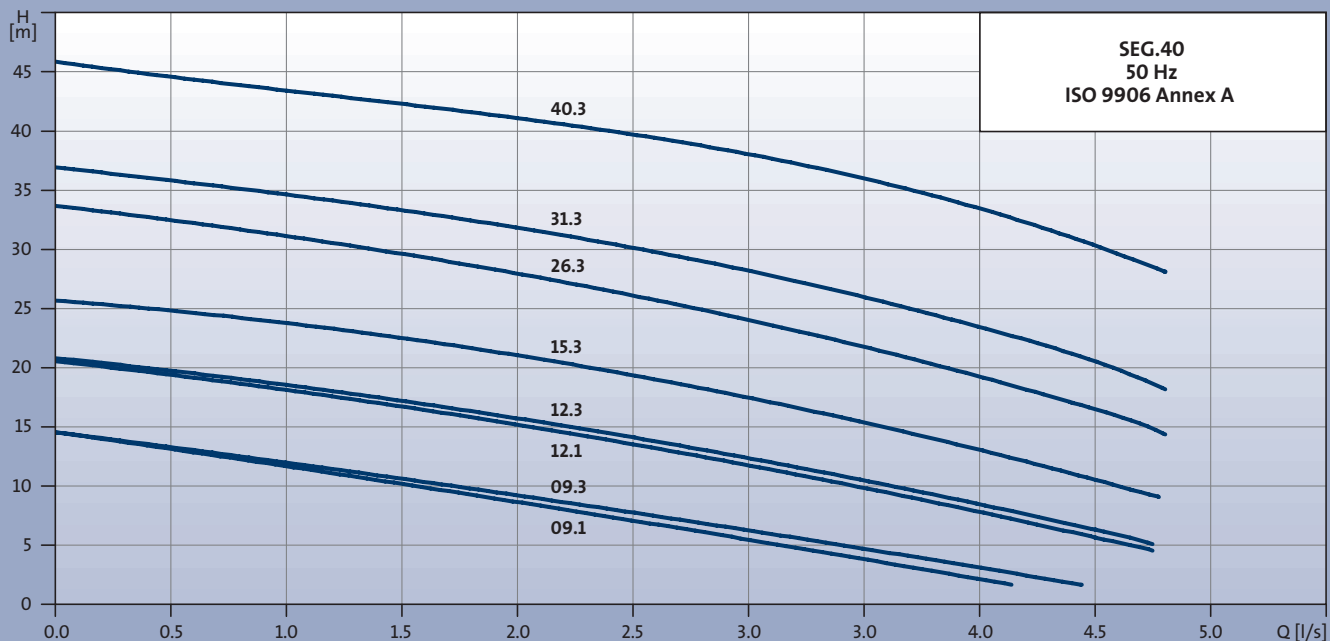

Type key

The type key covers the entire Grundfos SE range of wastewater pumps. This is why the type key has a number of empty fields for the grinder pumps. Each SEG pump is identified by means of the type key below. Please note that not all combinations are available.

Example SEG.40.11.Ex.2.1.502		SE	G		.40	.11		.Ex	.2	.1	5	02
Grundfos sewage pumps												
Impeller type	G	=	Grinder system in the pump inlet									
Material	□	=	(standard, cast iron)									
Max. spherical impeller clearance [mm] (not relevant for SEG pumps)												
Nominal diameter of discharge port [mm]												
Motor power output $P_2/100$ [W]												
Equipment in pump	□	=	(Standard without equipment)									
Installation version	□	=	Submerged without cooling jacket									
Ex version	□	=	Standard version of submersible wastewater pumps									
	Ex	=	The pump is designed according to the standard indicated									
Number of Poles	2	=	2-pole									
	4	=	4-pole									
Number of phases	1	=	Single-phase motor									
	□	=	Three-phase motor									
Frequency	5	=	50Hz									
Voltage and starting	02	=	230 V, direct-on-line starting									
	0B	=	400-415 V, direct-on-line starting									
	0C	=	230-240 V, direct-on-line starting									
Material in pump	□	=	Standard material in pump									

Operating conditions



Submersible pumps

The Grundfos range of submersible SEG pumps are specifically designed for use in pressurised systems for pumping domestic sewage and effluent. The pumps are designed for vertical installation with a horizontal discharge port.

The compact design makes these pumps suitable for temporary, free-standing portable use. The specially designed carrying handle makes it easy to lift and transport the pumps, regardless of the application.

Variants

The SEG range comprises models for single-phase or three-phase voltage supply, see table on page 9. All types are designed for voltage tolerances of $-10\%/+6\%$.

Pumped liquid

The SEG pumps are suitable for pumping domestic sewage and other liquids with a pH value of 4 to 10 in permanent installations. The SEG pumps are designed for fully submerged continuous operation or partly submerged intermittent operation with a maximum of 20 starts per hour.

In order to protect the grinder system, the pumped liquid must be free from mechanically wearing particles or abrasives such as sand or gravel.

Maximum temperature of pumped liquid: 40°C.

For short periods, maximum one hour, up to 60°C is permissible (non-Ex versions only).

Ambient temperature limitations: 40°C

Maximum submersion: 20 m

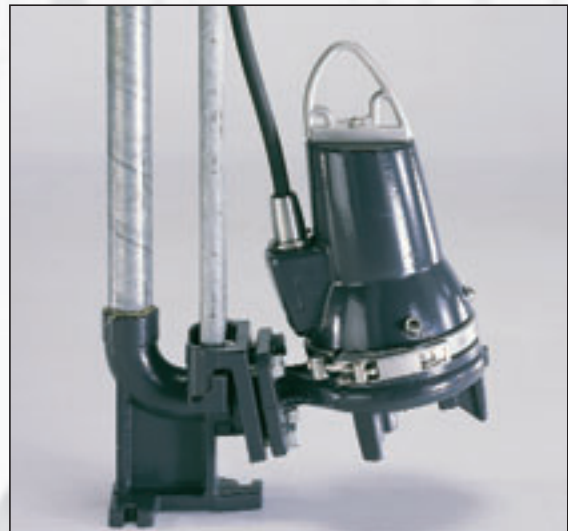

SmartSeal prevents leakage

The Grundfos SmartSeal auto-coupling gasket mounted on the pump discharge flange provides a completely leak-proof connection between the pump and the base unit of the auto-coupling system. This optimises the efficiency of the entire pumping system and keeps running costs at a minimum.

180° rotatable motor unit

The unique clamp system enables quick and easy detachment of motor unit from the pump housing. The motor can be turned either way, 180°, on the pump housing. This gives you the choice of various positions of the power cable.



Applications

Pressurised systems

The SEG pumps are ideal for use in sparsely populated areas where gravity sewage systems are not available. Examples include small villages, farm areas, and areas with difficult topography, such as rocky terrains with large differences in levels – or any other area where a pressurised system offers advantages.

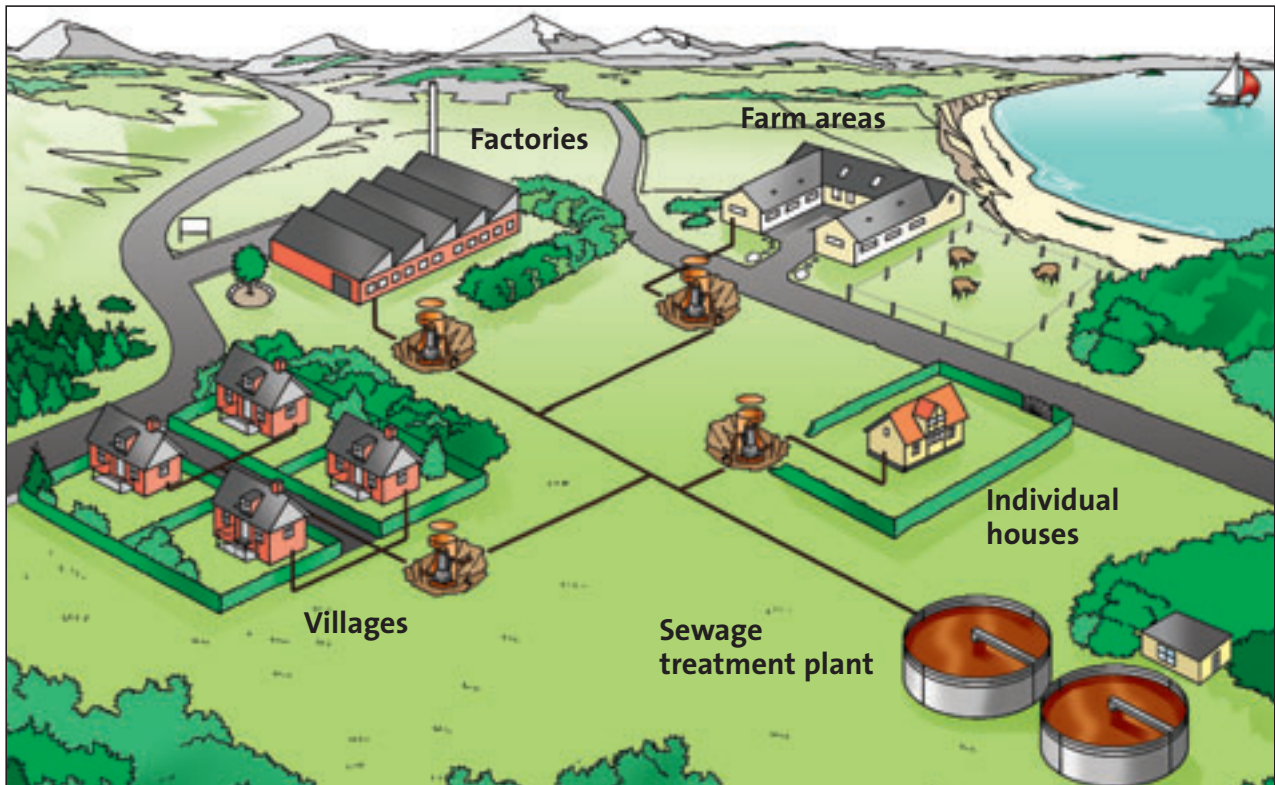

A highly efficient grinder system (patent pending) ensures that all sewage solids are ground down so that they can be pumped away through pipes with diameters down to 40 mm.

Approvals

All 50 Hz SEG pumps have been approved according to DIN EN 12050-1 for use in building services.

Explosion-proof versions

For applications involving a risk of explosion, or where otherwise required, explosion-proof versions of the SEG pumps are available. These models are provided with an II 2 G EEx d IIB T4 explosion-protection classification according to EN 50 014 (1997) + A1 & A2, and EN 50 018 (2000) + A1.

The SEG pumps are also available with an Ex nC II T3 classification in accordance with IEC 60079-15;1987.

Electrical data and pump designation

Pump type	Product number	P ₁ [kW]	P ₂ [kW]	n min ⁻¹	Voltage [V]	I _{1/2} [A]	I _{start} [A]	Ex-classification	Weight [kg]
SEG.40.09.2.1.502	96075893	1,3	0,9	2890	1x230	5,8	38,0		38,0
SEG.40.09.2.50B	96075897	1,4	0,9	2860	3x400-415	2,6	21,0		38,0
SEG.40.09.2.50C	96075919	1,4	0,9	2860	3x230-240	4,5	36,0		38,0
SEG.40.09.EX.2.1.502	96075894	1,3	0,9	2890	1x230	5,8	38,0	EEx d IIB T4	38,0
SEG.40.09.EX.2.1.502	96076161	1,3	0,9	2890	1x230	5,8	38,0	Ex nC II T3 X	38,0
SEG.40.09.EX.2.501	96075898	1,4	0,9	2860	3x400	2,6	21,0	EEx d IIB T4	38,0
SEG.40.09.EX.2.50B	96076162	1,4	0,9	2860	3x400-415	2,6	21,0	Ex nC II T3 X	38,0
SEG.40.12.2.1.502	96075901	1,8	1,2	2820	1x230	8,2	38,0		38,0
SEG.40.12.2.50B	96075905	1,8	1,2	2750	3x400-415	3,1	21,0		38,0
SEG.40.12.2.50C	96075920	1,8	1,2	2750	3x230-240	5,4	36,0		38,0
SEG.40.12.EX.2.1.502	96075902	1,8	1,2	2820	1x230	8,2	38,0	EEx d IIB T4	38,0
SEG.40.12.EX.2.1.502	96076163	1,8	1,2	2820	1x230	8,2	38,0	Ex nC II T3 X	38,0
SEG.40.12.EX.2.501	96075906	1,8	1,2	2750	3x400	3,1	21,0	EEx d IIB T4	38,0
SEG.40.12.EX.2.50B	96076164	1,8	1,2	2750	3x400-415	3,1	21,0	Ex nC II T3 X	38,0
SEG.40.15.2.50B	96075909	2,3	1,5	2700	3x400-415	3,8	21,0		38,0
SEG.40.15.2.50C	96075921	2,3	1,5	2700	3x230-240	6,6	36,0		38,0
SEG.40.15.EX.2.501	96075910	2,3	1,5	2700	3x400	3,8	21,0	EEx d IIB T4	38,0
SEG.40.15.EX.2.50B	96076165	2,3	1,5	2700	3x400-415	3,8	21,0	Ex nC II T3 X	38,0
SEG.40.26.2.50B	96075913	3,7	2,6	2870	3x400-415	5,3	33,0		57,0
SEG.40.26.2.50C	96075922	3,7	2,6	2870	3x230-240	9,2	57,0		57,0
SEG.40.26.EX.2.501	96075914	3,7	2,6	2870	3x400	5,3	33,0	EEx d IIB T4	57,0
SEG.40.26.EX.2.50B	96076166	3,7	2,6	2870	3x400-415	5,3	33,0	Ex nC II T3 X	57,0
SEG.40.31.2.50B	96075915	3,9	3,1	2900	3x400-415	6,3	43,0		65,0
SEG.40.31.2.50C	96075923	3,9	3,1	2900	3x230-240	10,9	74,0		65,0
SEG.40.31.EX.2.501	96075916	3,9	3,1	2900	3x400	6,3	43,0	EEx d IIB T4	65,0
SEG.40.31.EX.2.50B	96076167	3,9	3,1	2900	3x400-415	6,3	43,0	Ex nC II T3 X	65,0
SEG.40.40.2.50B	96075917	5,2	4,0	2830	3x400-415	8,2	43,0		65,0
SEG.40.40.2.50C	96075924	5,2	4,0	2830	3x230-240	14,2	74,0		65,0
SEG.40.40.EX.2.501	96075918	5,2	4,0	2830	3x400	8,2	43,0	EEx d IIB T4	65,0
SEG.40.40.EX.2.50B	96076168	5,2	4,0	2830	3x400-415	8,2	43,0	Ex nC II T3 X	65,0

Material specifications

Description	Material	DIN W. - NR/ EN standard	AISI/ ASTM
O-rings	NBR		
Grinder ring	Hardened stainless steel	1.4542	630
Grinder head	Hardened stainless steel	1.4542	630
Impeller	Cast-iron	EN-JL - 1030	
Pump housing	Cast-iron	EN-JL - 1030	
Stator housing	Cast-iron	EN-JL - 1030	
Clamp	Stainless steel	1.4301	304
Shaft seal	Primary seal (2.6-4.0 kW): SIC/SIC Secondary seal (2.6-4.0 kW): Carbon/aluminium oxide Other components: NBR rubber, stainless steel		
Rotor/shaft	Shaft part at rotor steel Shaft end at hydraulics: stainless steel	1.0533 1.4301	304
Screw	Stainless steel		
Lifting bracket	Stainless steel	1.4308	CF-8
Oil	Shell Ondina 913		
Paint	Two-component epoxy		

Technical data

Dimensions, free-standing

Pump type	Dimensions [mm]								
	A	D	E	F	G	H	K	S	T
SEG.40.09	458	71	257	154	214	99	123	116	502
SEG.40.12	458	71	257	154	214	99	123	116	502
SEG.40.15	458	71	257	154	214	99	123	116	502
SEG.40.26	527	60	292	173	254	117	143	116	582
SEG.40.31	567	60	292	173	254	117	143	116	622
SEG.40.40	567	60	292	173	254	117	143	116	622

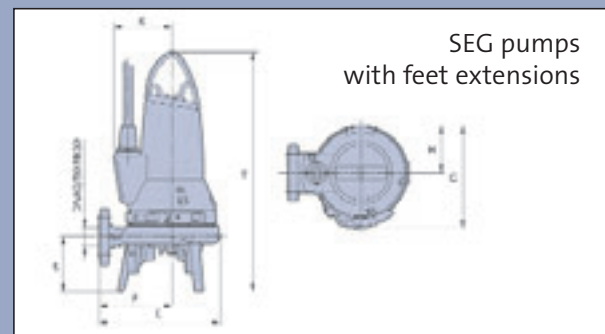
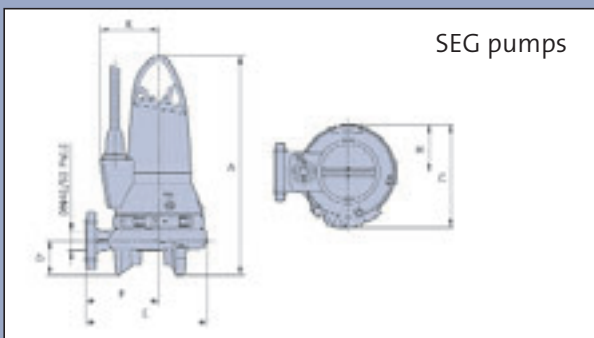

Submerged installation on auto-coupling system

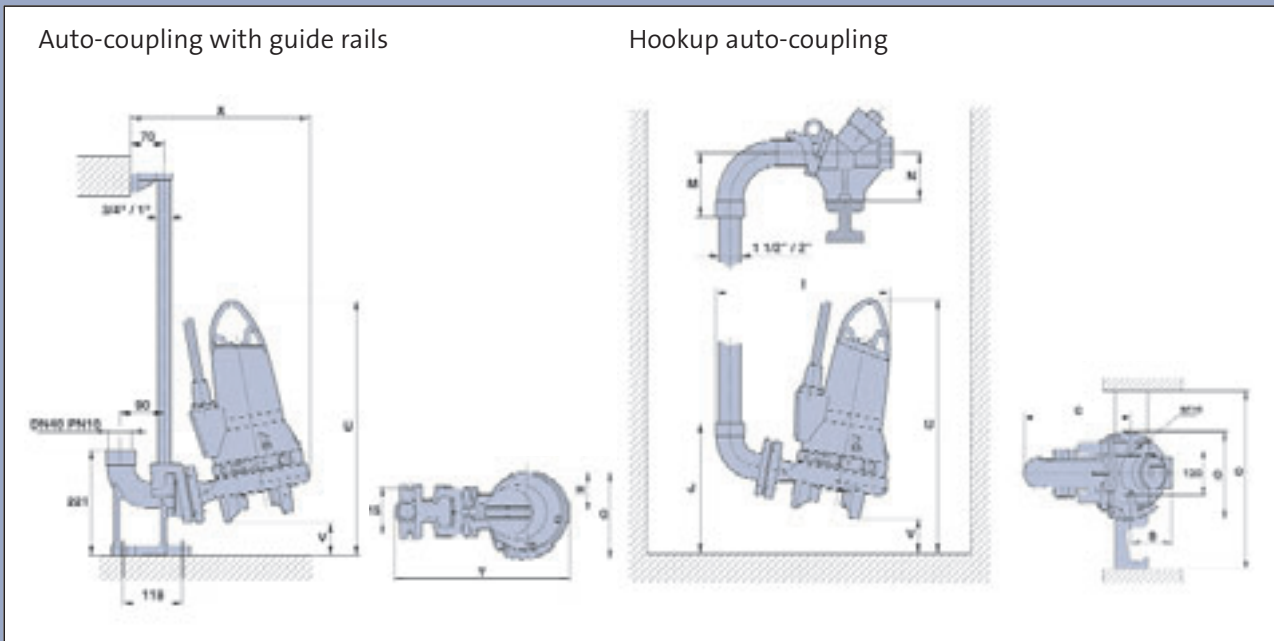















Dimensions

Pump type	Dimensions [mm]												
	B	C	G	H	I	J	M	N	O	U	V	X	Y
SEG.40.09	100	271	214	99	365	271	134	100	min 600	536	69	374	424
SEG.40.12	100	271	214	99	365	271	134	100		536	69	374	424
SEG.40.15	100	271	214	99	365	271	134	100		536	69	374	424
SEG.40.26	100	271	254	117	365	282	134	100		615	80	410	460
SEG.40.31	100	271	254	117	365	282	134	100		655	80	410	460
SEG.40.40	100	271	254	117	365	282	134	100		655	80	410	460

General information



The SEG pumps are suitable for free-standing installation on feet with a Storz hose coupling or for permanent installation on auto-coupling. The following table shows the complete range of accessories for SEG pumps.

No.	Picture	Description	Accessories	
			Dimensions	Product number
1		90° elbow	R/Rp 1½	96 00 19 79
			R/Rp 2	96 00 19 80
2		Coupling half Storz coupling	Rp 2 for 2" hose	96 00 19 82
			Rp 2½ for 2" hose	96 00 19 83
3		10 m rubber hose incl. Storz couplings	1½"	96 00 19 86
			2"	96 00 19 87
4		90° elbow	Rp/Rp 1½	96 48 99 56
			Rp/Rp 2	96 00 19 90
5		Hexagon nipple	R 1½	96 48 99 58
			R 2	96 00 19 93
6		Threaded flange	DN 40/Rp 1½	96 48 99 59
			DN 50/Rp 2	96 00 44 51
7		Bolts, nuts and gaskets	4 of each M16 x 65 mm, DN 40	96 48 99 70
			4 of each M16 x 65 mm, DN 50	96 00 44 52
8		Non-return valve Cast-iron ball-type valve	Rp/Rp 1½	96 48 99 72
			Rp/Rp 2	96 00 20 02
9		Isolating valve Brass	Rp/Rp 1½	96 48 99 73
			Rp/Rp 2	96 00 20 05
10		Isolating valve Cast-iron	Rp/Rp 1½	96 48 99 77
			Rp/Rp 2	96 48 99 76
11		Lifting chain with shackle – galvanized with certificates	10 m	96 49 74 64
			6 m	96 49 74 65
			3 m	96 49 74 66
12		Hookup auto-coupling – base stand, counterpart, bolts, nuts and gaskets, cast iron	DN 40/Rp 1½	96 07 60 89
			Rp/Rp 2	96 00 44 42
13		Auto-coupling system complete – upper guide rail holder, nuts, bolts, gaskets, guide claw and base stand, cast iron	DN 40/Rp 1½	96 07 60 63
14		3 loose feet to be fitted to the pump housing		96 07 61 96



Type Key for LC and LCD controllers

		Example:	LC	107	230	1	12	30/150	DOL
Controller type	LC =	One-pump controller							
	LCD =	Two-pump controller							
Type of level sensors	107 =	Control of 1 or 2 pumps based on signals from bell shaped level pickups (pneumatic) Max. 11 kW shaft power DOL							
	108 =	Control of 1 or 2 pumps based on signals from float switches or electrodes Max. 11 kW shaft power DOL Max. 30 kW shaft power SD							
	110 =	Control of 1 or 2 pumps based on signals from electrodes Max. 11 kW shaft power DOL							
Voltage [V]									
Number of phases	1 =	1 phase							
	3 =	3 phase							
Maximum operating current per pump [A]									
Operating / starting capacitor [μ F]									
[] = without capacitor									
30 = operating capacitor									
30/150 = 30 μ F operating and 150 μ F starting capacitor									
Starting methode	DOL =	Direct on-line starting							
	SD =	star-delta starting (only LC 108 and LCD 108)							

Note: Controllers with capacitor are for 12 A operating current.

No.	Picture	Accessories		Product number
		Description	Dimensions	
15		LC 107 controller, pneumatic version with level bells and tube for 1 pump 1 x 230 V, direct-on-line-starting. With built-in start and operating capacitors	3.7 -12.0 A 30/150 μ F	96 10 49 02
		LC 107 controller, pneumatic version with level bells and tube for 1 pump 3 x 400 V, direct-on-line-starting	1 - 2.9 A	96 00 24 67
			1.6 - 5.0 A	96 00 24 68
			3.7 - 12.0 A	96 00 24 69
12.0 - 23.0 A	96 00 24 70			
16		LCD 107 controller, pneumatic version with level bells and tube for 1 pump 1 x 230 V, direct-on-line-starting. With built-in start and operating capacitors	3.7 -12.0 A 30/150 μ F	96 10 49 03
		LCD 107 controller, pneumatic version with level bells and tube for 1 pump 3 x 400 V, direct-on-line-starting	1 - 2.9 A	96 00 24 74
			1.6 - 5.0 A	96 00 24 75
			3.7 - 12.0 A	96 00 24 76
12.0 - 23.0 A	96 00 24 77			
17		LC 108 controller for float switches for 1 pump 1 x 230V, direct-on-line-starting. With built-in start and operating capacitors	3.7 -12.0 A 30/150 μ F	96 10 49 14
		LC 108 controller for float switches for 1 pump 3 x 230 V, direct-on-line-starting	1 - 2.9 A	•96 43 39 75
			1.6 - 5.0 A	•96 43 39 79
			3.7 - 12.0 A	•96 43 39 83
		12.0 - 23.0 A	•96 43 39 87	
		LC 108 controller for float switches for 1 pump 3 x 400 V, direct-on-line-starting	1 - 2.9 A	•96 43 39 91
			1.6 - 5.0 A	•96 43 39 95
3.7 - 12.0 A	•96 43 39 99			
12.0 - 23.0 A	•96 43 40 03			

Product numbers marked with • are English versions. Other languages are available on request.

Accessories				Product number
No.	Picture	Description	Dimensions	
18		LCD 108 controller for float switches for 2 pumps 1 x 230V, direct-on-line-starting. With built-in start and operating capacitors	3.7 -12.0 A 30/150 µF	96 10 49 34
		LCD 108 controller for float switches for 2 pumps 3 x 230 V, direct-on-line-starting	1 - 2.9 A	•96 43 40 23
			1.6 - 5.0 A	•96 43 40 27
			3.7 - 12.0 A	•96 43 40 31
			12.0 - 23.0 A	•96 43 40 35
		LCD 108 controller for float switches for 2 pumps 3 x 400 V, direct-on-line-starting	1 - 2.9 A	•96 43 40 39
			1.6 - 5.0 A	•96 43 40 43
3.7 - 12.0 A	•96 43 40 47			
		12.0 - 23.0 A	•96 43 40 51	
19		LC 110 controller for electrodes for 1 pump 1 x 230 V, direct-on-line-starting. With built-in start and operating capacitors	3.7 -12.0 A 30/150 µF	96 10 49 45
		LC 110 controller for electrodes for 1 pump 3 x 400 V, direct-on-line-starting	1 - 2.9 A	96 48 40 85
			1.6 - 5.0 A	96 48 40 86
			3.7 - 12.0 A	96 48 40 87
			12.0 - 23.0 A	96 48 40 88
20		LCD 110 controller for electrodes for 2 pumps 1 x 230 V, direct-on-line-starting. With built-in start and operating capacitors	3.7 -12.0 A 30/150 µF	96 10 49 48
		LCD 110 controller for electrodes for 2 pumps 3 x 400 V, direct-on-line-starting	1 - 2.9 A	96 48 40 93
			1.6 - 5.0 A	96 48 40 94
			3.7 - 12.0 A	96 48 40 95
			12.0 - 23.0 A	96 48 40 96









Product numbers marked with • are English versions. Other languages are available on request.

Type Key for CU100 Control box

		Example:						
		CU	100	230	1	9	30/150	A
Type range								
Type designation								
Voltage [V]								
Number of phases	1 = 1 phase							
	3 = 3 phase							
Maximum amp. consumption for the pump [A]								
Operating / starting capacitor [µF]								
A = with float switch								
[] = without float switch								

Accessories				Product number
No.	Picture	Description	Dimensions	
21		CU 100 control box for one pump A model include float switch for automatic operation	CU 100.230.1.9.30/150	96 07 62 09
			CU 100.230.1.9.30/150.A	96 07 61 97
			CU 100.230.3.5.A	96 07 61 98
			CU 100.230.3.12.A	96 07 61 99
			CU 100.400.3.2,9.A	96 07 62 00
			CU 100.400.3.5.A	96 07 62 01

Accessories

No.	Picture	Accessories		Product number
		Description	Dimensions	
22		Float switch with 10 m cable	For LC 108 and LCD 108 controllers	96 00 33 32
		Float switch with 20 m cable		96 00 36 95
		Float switch for use in potentially explosive environments, with 10 m cable	For LC 108 and LCD 108 controllers connected to LC-Ex4	96 00 34 21
		Float switch for use in potentially explosive environments, with 20 m cable		96 00 35 36
23		Bracket for float switch		96 00 33 38
24		Standard float switches with 10 m cable and bracket	1 pump without alarm (2 switches)	62 50 00 13
			1 pump with alarm (3 switches)	62 50 00 14
			2 pumps without alarm (3 switches)	62 50 00 14
			2 pumps with alarm (4 switches)	62 50 00 15
25		Float switches for use in potentially explosive environments, with 10 m cable and bracket	1 pump without alarm (3 switches)	62 50 00 17
			1 pump with alarm (4 switches)	62 50 00 18
			2 pumps without alarm (4 switches)	62 50 00 18
26		LC-Ex4 intrinsically safe barrier, for use in potentially explosive environments, for float switch applications. The LC-Ex4 can be mounted in ambient temperatures ranging from -25°C to +50°C. Safety class: II (1) G [EEx ia] II °C.		96 44 03 00
27		Level electrodes for LC 110 and LCD 110	3 electrodes with 10 m cable	96 07 61 89
			4 electrodes with 10 m cable	91 71 34 37
28		Bracket for electrodes	To be mounted on a 38 mm pipe	91 71 31 96
29		Signal lamp, 1 x 230 V	Outdoor mounting	62 50 00 20
30		Acoustic signal (horn), 1 x 230 V	Outdoor mounting	62 50 00 21
			Indoor mounting	62 50 00 22

The Grundfos wastewater range

S range 5 – 29 kW

Brochure covers the Grundfos range of submersible channel-impeller pumps from 5 kW up to 21 kW and Super-Vortex pumps up to 29 kW. All designed for handling unscreened raw sewage. Available in 50 Hz and 60 Hz versions.



S range 15 – 155 kW

Brochure covers the Grundfos range of sewage pumps from 15 kW up to 155 kW for handling of raw sewage in heavy-duty applications. Available in 50 Hz and 60 Hz versions.



S/SA ranges Up to 520 kW

Brochure covers the Grundfos range of super-heavy-duty channel pumps, axial flow pumps, and propeller pumps from 7.5 kW up to 520 kW.



DW range 0.7 – 20 kW

Brochure covers the Grundfos range of portable dewatering pumps (DW) from 0.8 kW to 20 kW for pumping raw water with abrasives.

S range pumps 1.65 – 5.0 kW

The brochure covers the Grundfos range of heavy-duty submersible SuperVortex and channel-impeller pumps from 1.65 to 5.0 kW. All suitable for unscreened sewage.



Multilift M, MD, MDV, and MD1 ranges

Brochure covers Grundfos lifting stations for individual as well as multi-user applications.



Prefabricated pumping stations

Brochure covers the Grundfos range of prefabricated pumping stations for collecting and removing drainwater, surface water, domestic and industrial wastewater and sewage.



DP, EF, SE1 and SEV ranges 0.6 – 2.6 kW

Brochure covers the Grundfos range of submersible channel-impeller and Super-Vortex-impeller pumps from 0.6 to 2.6 kW. Designed for handling drainage, effluent and sewage from private dwellings.



LC/LCD Ranges – level controllers

Brochure covers the Grundfos range of controls for the wastewater pumping systems.



SEN range 1.0 – 21 kW

Brochure covers the Grundfos range of heavy-duty stainless steel pumps (SEN) for aggressive and corrosive environments.

AMD, AMG, and AFG ranges

Brochure covers the new range of mixers and flowmakers for optimal control of liquids and solids throughout the wastewater treatment process.

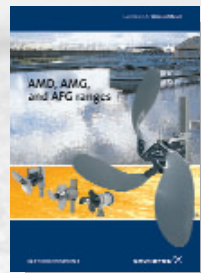

SE1 and SEV ranges 1.1 – 11 kW

This brochure describes the innovative SEV/SE1 pump lines. Fitted with Super-Vortex or single-channel impellers, these pumps can meet approximately 80% of all wastewater pumping needs.

SRP range 3.0 – 24 kW

Brochure covers the Grundfos range of SRP submersible recirculation pumps for wastewater treatment plants and flood control. Available in 50 Hz and 60 Hz versions.



Business with an attitude

Knowledge The sharing of knowledge, experience and expertise across our global network will always lead our business forward.

Innovation Combining the best technology with fresh ways of thinking, we will continue to develop even better pumps, systems, services and standards.

Solution With a complete product range, capable of providing every conceivable water solution, we are the most complete player on the market.