



# *Rotary Air Blowers*

# RSR



## Features

It is generally recognized that air-blowers produce high operation noise due to impact and pulsation when it sucks and discharges air in a gust. The Tsurumi model RSR rotary blower incorporates a 3-lobe helical rotor(\*) that greatly lowers noise by a structure that continuously conveys air. Another characteristic of the 3-lobe rotor is that it reduces torque fluctuation and stabilizes flow volume.

(\*) Model RSR-50K or RSR-65K has a spur type rotor.



3-lobe Helical Rotor

## Applications

- Aeration in sewage or industrial wastewater treatment plants
- For air-lift pumps in sewage or industrial wastewater treatment plants
- Oxygen supply at aquariums and fish farms
- Pneumatic conveyer

## Major Standard Specifications

Blower	Fluid	Type of Fluid	Air	
		Temperature	0~40°C	
	Components	Rotor	3-lobe Helical Type (RSR-50K/RSR-65K: 3-lobe Spur Type)	
		Shaft Seal	Labyrinth	
		Bearing	Ball or Roller Bearings	
	Materials	Rotor	Gray Iron Casting	
		Casing	Gray Iron Casting	
Shaft		Carbon Steel		
Gear		Chromium Molybdenum Steel		
Discharge Connection	RSR-50K and RSR-65K: JIS5kg/cm <sup>2</sup> Flange RSR-80K thru RSR-300K: JIS10kg/cm <sup>2</sup> Flange			
Motor	Type	Indoor-use, drip-proof type		
	No. of poles	4-pole		
	Voltage	3-phase, 220, 380, 400, 415, 440, 460 volts		

## Standard Accessories

- Common Base
- Indoor use Drip-proof Motor
- Suction Silencer (with Air Filter)
- Discharge Silencer
- V-Belt and Belt Cover
- Safety Valve
- Foundation Bolts

## Optional Accessories

- Pressure Gauge
- Expansion Joint
- Gate Valve
- Check Valve
- Acoustic Hood
- Vibration-Isolation Base with Rubber Feet
- TEFC motor

## Installation Diagram (Example)

Optional accessories

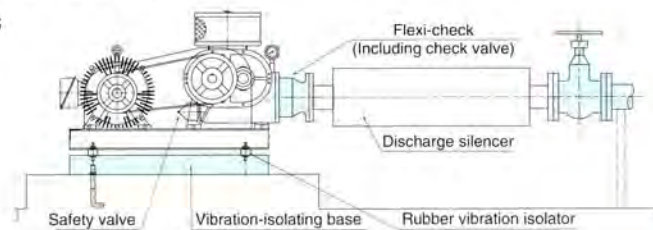

## Dimensions

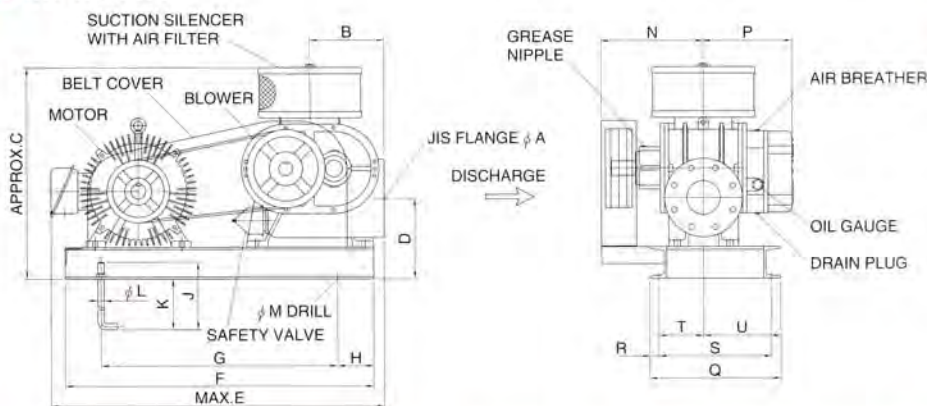

## Table for Motor Weight

(Unit : kgs)

Motor	Weight	Motor	Weight
1.5kW	20	22kW	166
2.2kW	30	30kW	182
3.7kW	39	37kW	282
5.5kW	56	45kW	282
7.5kW	70	55kW	420
11kW	109	75kW	575
15kW	136	90kW	750
19kW	166		

Note : Weight of standard motor of a manufacturer.  
Subject to change according to the type and make.

(Unit : mm)

Model	A (nominal)	B	C	D	E	F	G	H	J	K	φ L	φ M	N	P	Q	R	S	T	U	Weight* (kgs)
RSR-50K	50	135	410	160	700	650	450	100	250	210	12	15	210	160	300	20	260	120	160	57
RSR-65K	65	135	430	160	700	650	450	100	250	210	12	15	225	160	300	20	260	145	135	60
RSR-80K	80	175	520	190	800	750	550	100	300	250	16	19	270	215	320	20	280	145	175	118
RSR-100K	100	175	540	190	880	800	600	100	300	250	16	19	290	235	440	20	400	120	300	133
RSR-125K	125	205	635	235	1005	850	650	100	300	250	16	19	360	260	420	25	370	165	230	226
RSR-125LK	125	255	705	235	1005	950	750	100	300	260	16	19	360	275	480	25	430	135	295	299
RSR-150LK	150	255	765	250	1155	1100	850	125	300	260	16	19	465	350	550	25	500	210	290	365
RSR-200K	200	310	950	300	1500	1200	950	100	300	250	19	23	485	375	560	30	500	240	290	550
RSR-250K	250	348	1173	335	1370	1300	950	200	300	250	20	23	520	416	690	30	630	265	395	805
RSR-300K	300	450	1464	465	2000	1800	1400	200	300	250	20	23	620	528	760	35	700	345	400	1171

\* Weight of blower and standard accessories not including motor. See the table above for the motor weight.

# Performance Curves

**RSR-50K**

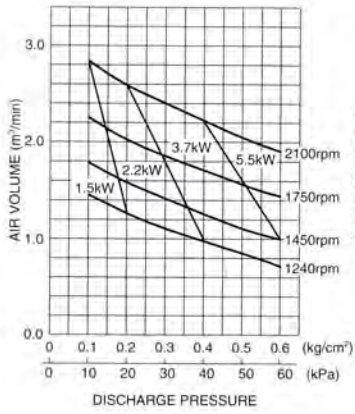

**RSR-65K**

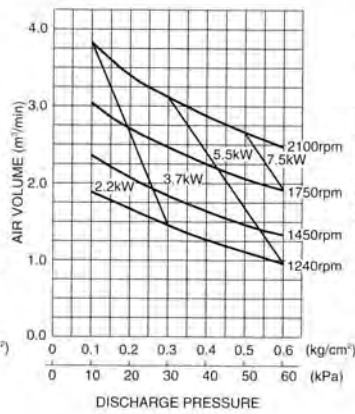

**RSR-80K**

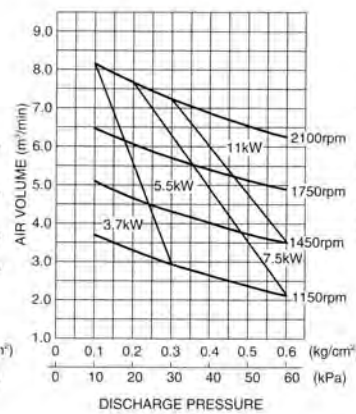

**RSR-100K**

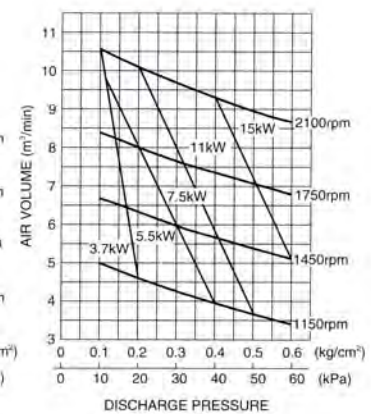

**RSR-125K**

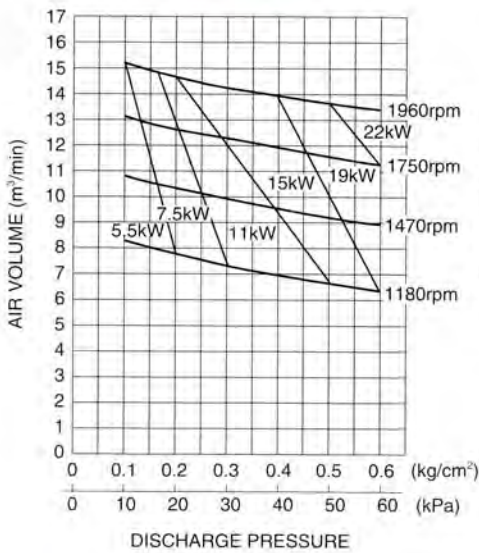

**RSR-125LK**

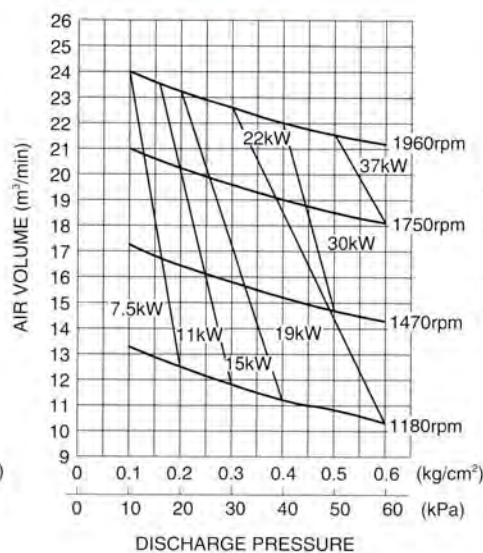

**RSR-150LK**

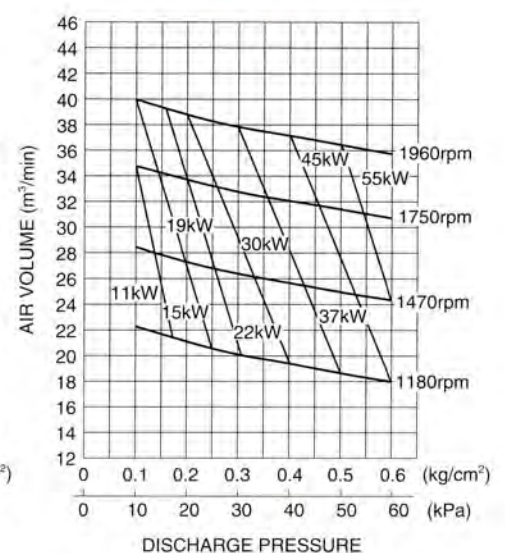

**RSR-200K**

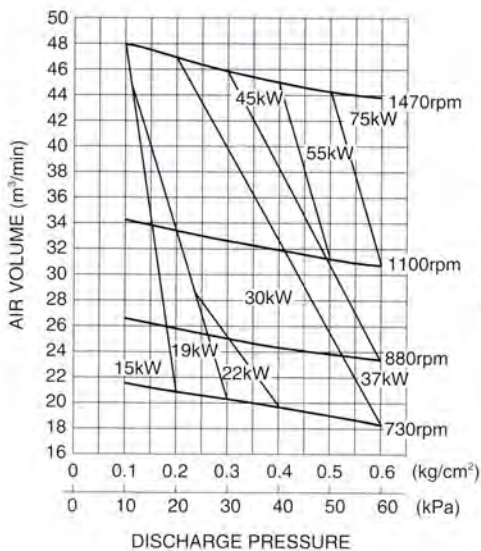

**RSR-250K**

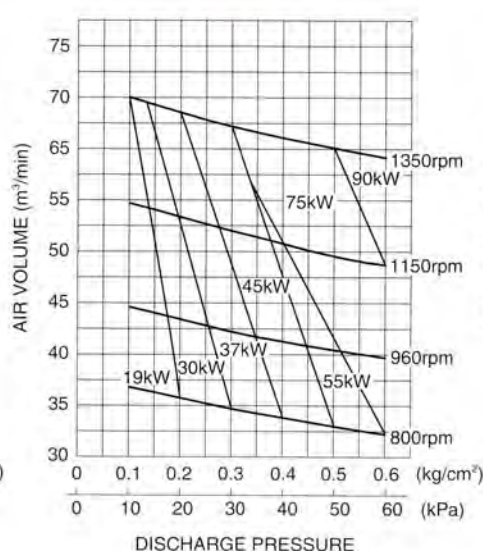

**RSR-300K**

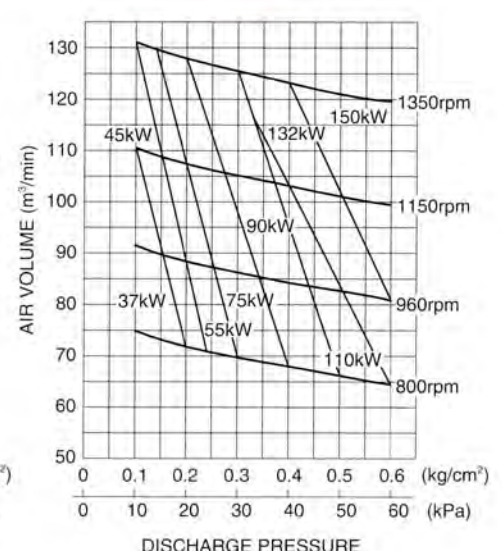

## Selection Chart

Blower Type (Discharge in mm)	Speed (rpm)	Suction air volume at standard conditions (Qs, m <sup>3</sup> /min) and required power (La, kW)																									
		0.1kg/cm <sup>2</sup> (9.8kPa)		0.2kg/cm <sup>2</sup> (19.6kPa)		0.3kg/cm <sup>2</sup> (29.4kPa)		0.4kg/cm <sup>2</sup> (39.2kPa)		0.5kg/cm <sup>2</sup> (49.0kPa)		0.6kg/cm <sup>2</sup> (58.8kPa)															
		Qs	La	Qs	La	Qs	La	Qs	La	Qs	La	Qs	La														
RSR -50K (50)	1240	1.46	0.74	1.26	1.07	1.12	1.37	0.99	1.68	0.86	2.02	0.72	2.32	RSR (125)	1180	13.29	3.90	12.50	6.27	11.81	8.65	11.22	11.02	10.83	13.40	10.33	15.77
	1450	1.79	0.87	1.58	1.23	1.42	1.58	1.27	1.94	1.12	2.31	1.00	2.68		1470	17.23	4.89	16.42	7.92	15.82	10.95	15.21	13.98	14.70	17.11	14.29	20.53
	1750	2.25	1.02	2.03	1.48	1.87	1.95	1.72	2.41	1.57	2.88	1.45	3.34		1750	21.00	5.85	20.20	9.45	19.60	13.06	19.00	16.67	18.50	20.57	18.10	24.46
	2100	2.84	1.24	2.58	1.82	2.40	2.39	2.23	2.98	2.05	3.57	1.91	4.16		1960	23.99	6.55	23.19	10.59	22.61	14.70	22.02	18.85	21.55	23.37	21.18	27.93
RSR -65K (65)	1240	1.90	0.97	1.66	1.36	1.46	1.70	1.27	2.06	1.12	2.39	0.96	2.63	RSR -150LK (150)	1180	22.27	6.07	21.14	10.06	20.11	14.16	19.39	18.41	18.67	22.59	17.96	26.72
	1450	2.35	1.10	2.08	1.57	1.84	1.98	1.63	2.44	1.46	2.86	1.34	3.36		1470	28.39	7.67	27.27	12.67	26.36	17.84	25.65	23.32	24.94	28.60	24.33	34.06
	1750	3.04	1.35	2.70	1.93	2.46	2.51	2.25	3.19	2.07	3.85	1.92	4.60		1750	34.80	9.17	33.70	15.41	32.80	21.69	32.10	28.38	31.40	34.88	30.70	41.29
	2100	3.81	1.62	3.40	2.32	3.11	3.03	2.86	3.87	2.64	4.68	2.48	5.65		1960	39.95	10.22	38.80	17.23	37.84	24.30	37.10	31.85	36.40	39.25	35.76	46.70
RSR -80K (80)	1150	3.72	1.45	3.31	2.16	2.96	2.74	2.67	3.31	2.37	3.76	2.14	4.19	RSR -200K (200)	730	21.57	6.02	20.94	10.14	20.29	14.48	19.68	18.83	19.08	22.84	18.48	26.74
	1450	5.09	1.79	4.68	2.75	4.33	3.60	4.04	4.50	3.75	5.36	3.52	6.20		880	26.52	7.11	25.78	12.22	25.14	17.46	24.43	22.70	23.87	27.53	23.44	32.23
	1750	6.46	2.09	6.05	3.27	5.70	4.36	5.41	5.55	5.12	6.73	4.88	7.91		1100	34.24	8.82	33.40	15.18	32.63	21.98	31.93	28.56	31.24	34.70	30.84	40.98
	2100	8.14	2.51	7.64	3.94	7.22	5.27	6.88	6.71	6.53	8.17	6.24	9.63		1470	47.85	11.71	46.98	20.36	45.87	29.27	44.99	38.12	44.42	46.57	43.84	55.38
RSR -100K (100)	1150	5.01	1.82	4.60	2.82	4.25	3.73	3.94	4.73	3.67	5.73	3.43	6.73	RSR -250K (250)	800	36.82	9.75	35.86	16.43	34.81	23.47	33.95	30.51	33.09	37.01	32.23	43.33
	1450	6.71	2.18	6.31	3.45	5.96	4.64	5.65	5.82	5.37	7.09	5.13	8.36		960	44.63	11.70	43.47	19.72	42.28	28.17	41.35	36.61	40.43	44.41	39.53	52.00
	1750	8.41	2.55	8.01	4.09	7.66	5.64	7.35	7.18	7.07	8.64	6.83	10.18		1150	54.58	13.84	53.29	23.70	52.06	34.23	50.95	44.34	49.54	53.61	48.60	63.01
	2100	10.57	3.05	10.09	4.91	9.67	6.78	9.30	8.69	8.96	10.43	8.67	12.31		1350	64.99	15.90	63.61	27.52	62.29	39.74	61.10	51.77	60.02	63.18	59.18	74.98
RSR -125K (125)	1180	8.22	2.59	7.74	4.17	7.31	5.75	6.94	7.33	6.70	8.92	6.40	10.50	RSR -300K (300)	800	74.64	20.81	71.85	30.73	69.81	44.04	67.88	57.36	66.26	70.67	64.65	84.15
	1470	10.78	3.32	10.27	5.38	9.89	7.44	9.51	9.51	9.19	11.63	8.94	13.96		960	91.31	24.37	88.39	36.98	86.23	53.40	84.35	69.87	82.61	86.15	80.78	102.14
	1750	13.13	3.98	12.63	6.43	12.26	8.88	11.88	11.33	11.57	13.98	11.32	16.63		1150	110.48	29.20	107.47	44.52	105.15	64.48	103.07	84.53	101.13	104.43	99.50	124.50
	1960	15.16	4.45	14.65	7.19	14.29	9.99	13.92	12.81	13.62	15.88	13.39	18.98		1350	130.99	34.27	128.05	52.52	125.29	76.06	123.17	100.01	121.21	123.93	119.70	148.40

1.5kW	7.5kW	22kW	55kW	132kW
2.2kW	11kW	30kW	75kW	150kW
3.7kW	15kW	37kW	90kW	
5.5kW	19kW	45kW	110kW	

## How To Select The Blower Model

The above Selection Chart indicates the relationships between blower model, bores, revolutions, discharge pressures, actual air flow rates, and the shaft powers.

1. The amount of air indicated in the Selection Chart represents the suction amount under the following standard conditions: temperature 20°C, absolute pressure 101.3kPa, and relative humidity 65%.
2. The amount of air under reference conditions (0°C, absolute pressure 101.3kPa, dry) can be converted to amounts of air under standard suction conditions by the formula below if the suction pressures are the same:

$$Q_s = Q_n \times \frac{273 + t_s}{273}$$

where

Qs, amount of air (m<sup>3</sup>/min.) under standard suction conditions indicated on the Selection Chart;

Qn, amount of air (m<sup>3</sup>/min.) under reference suction conditions;

Suction pressure is ambient pressure, 101.3kPa;

t s, suction temperature in °C

3. To convert amounts of air under discharge conditions to amounts of air under standard suction conditions indicated on the Selection Chart, use the following formula:

$$Q_s = Q_d \times \frac{101.3 + P_d}{101.3} \times \frac{273 + t_s}{273 + t_d}$$

Qd, amount of air (m<sup>3</sup>/min.) under discharge conditions;

Pd, discharge pressure (kPa)

Ts, suction temperature in °C

Td, discharge temperature in °C

4. Using the amount of air and the necessary discharge pressure obtained from the above calculations, determine your blower model, bore, revolution, and shaft power referring to the Selection Chart.
5. Your selectable range can overlap several models. It is recommended that one with a smaller model number be selected for cost economy, or one with a larger model number be selected for lower noise.
6. Necessary motor output is color-coded in the Selection Chart. Select a suitable motor that is located in the range.

Note: This formula can be applied in cases where the relative humidity is 65%. Though changes in relative humidity affect the amount of air, they can be ignored as they are negligible.

We reserve the right to change the specifications and designs for improvement without prior notice.

# TSURUMI MANUFACTURING CO., LTD.

## PT. LUKES INDONESIA

Lindeteves Trade Center Lt UG, Blok B1 No. 6

Jalan Hayam Wuruk, Jakarta - Indonesia

Phone : 021 - 6231 7842, 628 5144

Fax : 021 - 6231 0499

email : lukes@cbn.net.id

