



Submersible Pumps for Industrial and Sewerage



Only the Highest Quality Parts

Cable Entry

Every cable has an anti-wicking block at the cable entry section on the pump. This mechanism is such that a part of each conductor is stripped back and the part is sealed by molded rubber or epoxy potting which has flowed in between each strand of the conductor. This unique feature prevents wicking under the strands of the conductor itself.



Motor Protectors

Use of a Circle Thermal Protector (CTP) in small pumps is advantageous in applications where a control panel is not likely provided.



Integrated in the motor housing, the CTP directly cuts the motor circuit if excessive heat builds up or an overcurrent caused by an electrical or mechanical failure occurs.

A Miniature Thermal Protector (MTP) is imbedded in each winding of the 3-phase motor. These MTPs are connected in series, and their wires are led out of the motor. Should the winding temperature rise to the actuating temperature, the bimetal strip opens to cause the control panel to shut the power supply.



MTPs are supplied as standard on all 11 kW pumps or over. CTPs are supplied on smaller pumps.

Motor

The motor is a dry-type, squirrel cage induction motor, housed in watertight housing, and conforms to insulation classes B, E or F. In each of these insulation classes, all standard pumps can be used in ambient temperatures up to 40°C.

Mechanical Seal

All pumps are provided with a silicon carbide dual-inside mechanical seal that is located completely out of the pumpage, running in an oil-filled chamber. The advantages of this seal are two-fold. It eliminates spring failure caused by corrosion, abrasion or fouling which prevents the seal faces from closing properly, and prevents loss of cooling to the bottom seal faces during run-dry conditions which causes the bottom seal to fail.



Oil Lifter (Patent Pending)

Utilizing the rotational energy of the shaft, the oil lifter continues to supply lubricant to the top seal faces even if lubricant falls below the rated volume. This amazingly simple device not only turns wasted energy into added protection but also doubles the life expectancy of the mechanical seal and also the maintenance term. (The oil lifter is supplied on all pumps.)

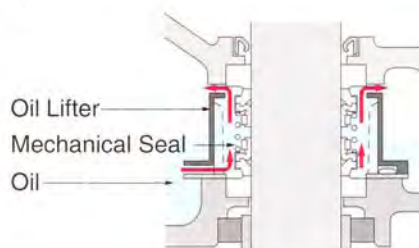

Shaft

The high-tensile stainless steel used on all pumps is designed to have adequate strength for the transmission of the full load.

Shafts are supported by C3 type, high-quality, deep-groove ball bearings.

Leakage Sensor

A stainless-steel, electrode type leak sensor is standardized for large pumps of 22 kW or over.



go into Tsurumi pump

GUIDE RAIL FITTING SYSTEM

We recommend using the Tsurumi guide rail fitting system with pumps. This system connects the pump to and from the piping easily just by lowering and hoisting the pump, allowing easy maintenance and inspection without the need to enter the sump. Pump models used in combination with the guide rail fitting system are identified by the prefix TO or TOS. Refer to the specifications table for details of the correct model number.

TO and TOS

The TO or TOS guide rail fitting system is made of cast iron and is compatible with Tsurumi cast-iron pumps. Models having a pump discharge of between 50mm through 800mm are available. Refer to the catalog for each pump series for the correct model number prefixed with TO or TOS.



TS

This compact guide rail fitting system is ideal for installing on prefabricated lift stations. Its discharge flange is compatible with major flange standards including ANSI 150lb, BS PN10, and DIN PN10. Four models are available and can be used on Tsurumi cast-iron pumps in the 50 mm through 100 mm discharge bore range.



TOK

Made of high-quality resin, the TOK is designed for light-weight, small pumps. Rubber bellows attached to the guide hook are inverted to the duckfoot bend when the pump starts operating. This eliminates leakage at the seal even if a light-weight pump is used in combination with the TOK.



AUTOMATIC TYPE

The Tsurumi automatic type pump has an integral control circuit and two float switches operated at a low voltage.

This pump has an auto-cut, self-resetting Circle Thermal Protector (CTP) integrated into the motor to protect the motor from overload or overheating.

This type can be identified by the suffix "A" and is available in the following pump series:

Series	Impeller Type	Output Range
B	Channel	0.75 through 3.7kW
C	Cutter	0.75 through 1.5kW
PN	Vortex	0.25 through 1.5kW
PU	Vortex	0.15 through 1.5kW
U	Vortex	0.25 through 3.7kW
UZ	Vortex	1.5 through 3.7kW

Refer to the specification table for availability and model numbers.



AUTO-ALTERNATION TYPE

In addition to standard automatic pumps, Tsurumi offers auto-alternation type pumps. Automatic alternation operation is achieved by combining a parent pump (three floats) with a standard automatic pump (two floats). This enables each pump to operate alternately without the aid of a control panel.

How the Auto-alternation Type Works

● Operation is enabled by merely connecting the power supply.

Primary Operation

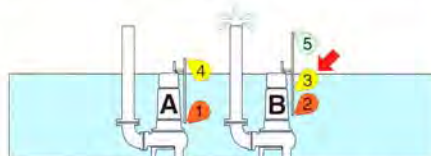

1 Float 3 operates, and pump B starts to discharge water.

Secondary Operation

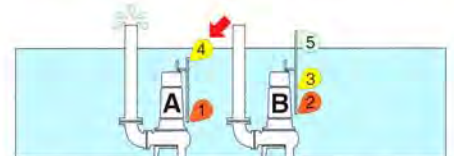

1 Start float 4 of pump A operates to start water discharge.

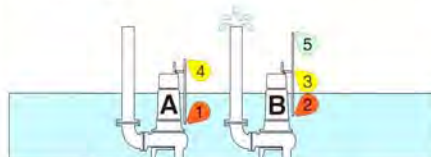

2 Water is discharged (water level falls).

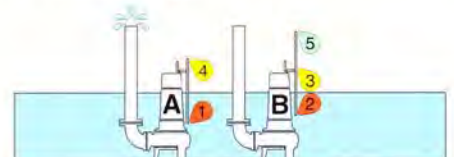

2 Water is discharged (water level falls).

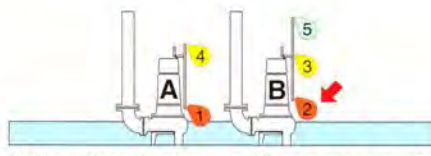

3 Stop float 2 of pump B operates to end water discharge. At this time, alternation start float 3 of pump B rests for one discharge operation.

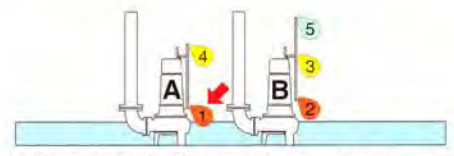

3 Stop float 1 of pump A operates to end water discharge. At the same time, start float 3 of pump B becomes ready for operation.

※ Primary operation and secondary operation are repeated alternately.

※ Both primary and secondary operations are performed simultaneously when water has risen to an abnormal level.

The parent pump can be identified by the indication "W". Auto-alternation type pumps are available in the same output range as standard automatic pumps.

Tsurumi the resource of water

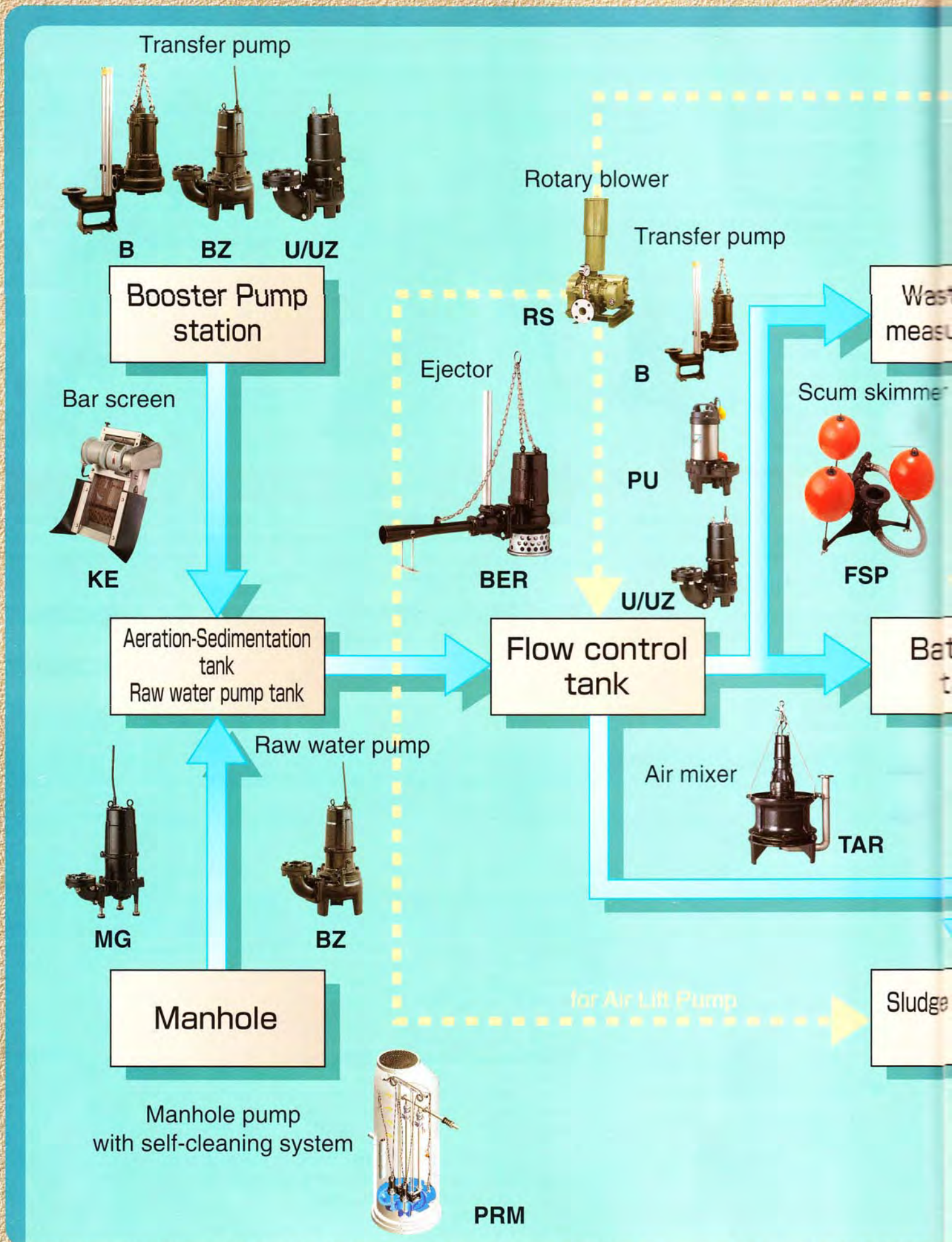

control treatment potentials

Water is indispensable for mankind. Once used, it must be restored to its original condition. This is mankind's responsibility.

Tsurumi has been devoting its energies to developing a variety of water treatment equipment that includes world-class submersible pumps. This is just one example of Tsurumi's commitment to recycling water-one of nature's valuable resources.

Screening Equipment with Dehydrator



SDA

Water
purifying tank

Decanter



FHP

Deforming pump



SF



PSF

Effluent pump



PN



B

Water
catching tank

Spray pump
tank

Disinfecting
chamber

Aerator



TR

Water
condensing tank

Sludge storing
tank

Dehydrator



DS

Aerator



TRN

You Can Find All You Need in

Tsurumi provides you with an extensive lineup of models to suit your specific needs. Select the most suitable pump from this extensive product lineup.

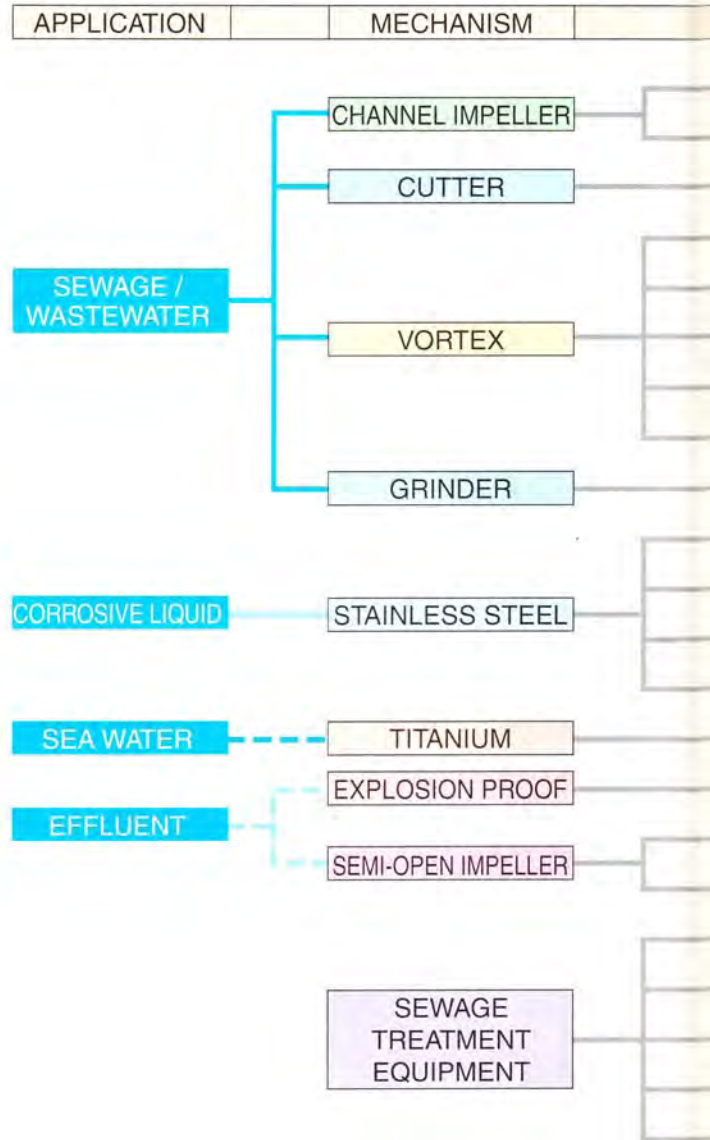

COMPOSITION OF THE MODEL NAME

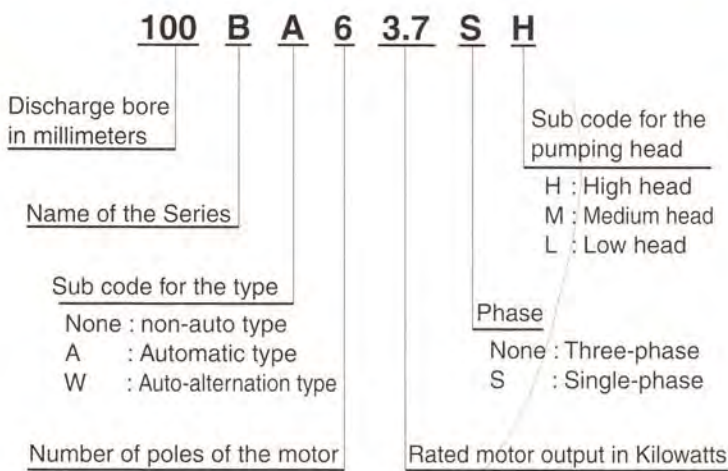

VARIETY OF IMPELLER

CHANNEL IMPELLER



An impeller having a wide channel extending from inlet to exit, which prevents internal clogging by solids sucked in via the inlet.

CUTTER IMPELLER



A "cutter mechanism" is provided by the combined action of a carbide blade integrated into a non-clog impeller and the sawshaped inner surface of a suction cover.

This cutter mechanism cuts up fibrous foreign matter to facilitate transfer.

VORTEX IMPELLER



An impeller used mainly in volute pumps. Vortex impellers pump water by the eddy flow caused by interaction with the casing, which prevents internal clogging by solids and fibrous matter.

GRINDER



A grinding mechanism is provided at the suction inlet of the pump.

Flown in suspended solids are cut into small pieces and pumped out without a fear of clogging in the discharge pipe.

our Extensive Product Lineup

SERIES	BORE	OUTPUT	FEATURE	PAGE
B	50-800	0.4-110	Basic sewage pumps with an extensive variation	P7-8
BZ	80-100	1.5-15	Sewage pumps with large solid passage	P8
C	50-100	0.75-15	Sewage pumps with cutter mechanism	P8
OM	32	0.15	Domestic-use drainage pump	P9
PN	40-50	0.25-1.5	Resin-made pumps for miscellaneous drainage	P9
U	32-80	0.15-3.7	Small pumps with 2-pole motor	P9
UZ	50-100	1.5-11	Sewage pumps with large solid passage	P9
PU	40-80	0.15-1.5	Resin-made sewage pumps	P10
MG	32-50	1-3.7	For high head pumping and pressure sewer	P10
SQ	40-50	0.25-0.75	Stainless-steel light-weight pumps	P10
SFQ	50-80	0.4-11	Cast stainless steel dewatering pumps	P10
BQ	50-100	0.4-3.7	Cast stainless steel version of B-series	P11
CQ	50-100	0.75-3.7	Cast stainless steel version of C-series	P11
TM	40-50	0.25-0.75	Titanium and fiber reinforced plastic	P11
KTX	50-100	0.4-11	Under flammable atmosphere	P11
PSF	40-50	0.25-1.5	Resin-made high pressure pump	P12
SF	50-80	0.75-11	Cast iron high pressure pump	P12
TR	---	0.75-22	Submersible aerator	P13
TRN	---	0.75-11	Non-clog submersible aerator	P13
BER	---	0.75-5.5	Submersible ejector	P13
FSP	50	0.4-0.75	Scum skimmer	P12
FHP	40-80	0.25-1.5	Float type decanting pump	P12

OPTIONS

Special Version with Galvanic Corrosion Protection

In sea water, the effect of galvanic corrosion is more serious than that of ordinary corrosion. When two different kinds of metals are dipped into an electrolytic liquid, a battery phenomenon occurs due to the difference in the electric potential of the two metals. In this case, the metal having the higher potential corrodes first. As an option, Tsurumi can supply pumps with parts made of higher electric potential metal as the sacrificial anode.

Special Version for Higher Temperature Liquids

Standard pumps are designed for continuous running at a maximum ambient temperature of 40°C. In addition to these, Tsurumi can provide pumps for operation at higher liquid temperatures upon request. Refitting for operation at higher temperatures involves modification of not only the insulation of motor windings but also several components.

Two high-temperature operation models are available-the Rank 60 for operation in liquids up to 60°C and the Rank 90 for operation in liquids up to 90°C. Consult your dealer for more details. (These special versions are not available for some pump models.)

Special Version with Non-standard Materials

Tsurumi can also provide you with pumps with essential components such as the impeller, pump casing and suction cover made of non-standard materials. Select from stainless-steel, chromium iron and bronze to suit your specific requirements. Consult your dealer for more details.

SEWAGE / WASTEWATER

B SEWAGE / WASTEWATER CHANNEL

The B pump incorporates a channel impeller developed exclusively for sewage pumps, ensuring the efficient transfer of suspended solids.

An extra line-up with discharge bore diameters from 50 to 800mm is available.

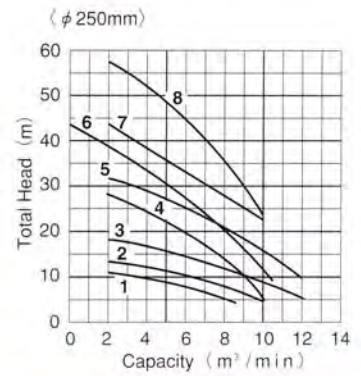

Curve No.	Model	Discharge Bore mm	Motor Output kW
1	250B611	250	11
2	250B415	250	15
3	250B622	250	22
4	250B430	250	30
5	250B437	250	37
6	250B445	250	45
7	250B455	250	55
8	250B475	250	75

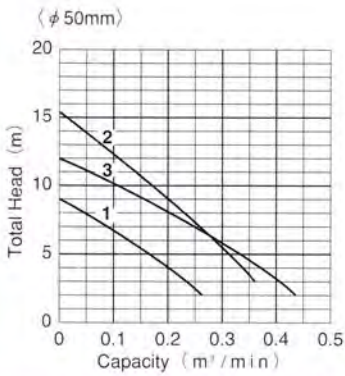

Curve No.	Model		Discharge Bore mm	Motor Output kW
	Standard	Automatic		
2	50B2.75S	50BA2.75S	50	0.75
1	50B2.4	—	50	0.4
3	50B2.75	—	50	0.75
2	50B2.75H	—	50	0.75

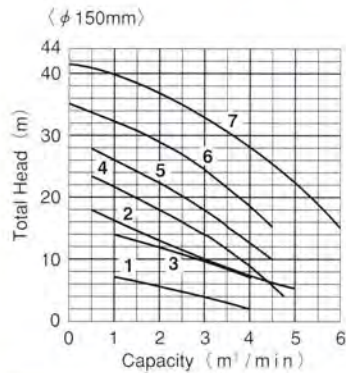

Curve No.	Model	Discharge Bore mm	Motor Output kW
1	150B63.7	150	3.7
2	150B47.5H	150	7.5
3	150B47.5L	150	7.5
4	150B411	150	11
5	150B415	150	15
6	150B422	150	22
7	150B437	150	37

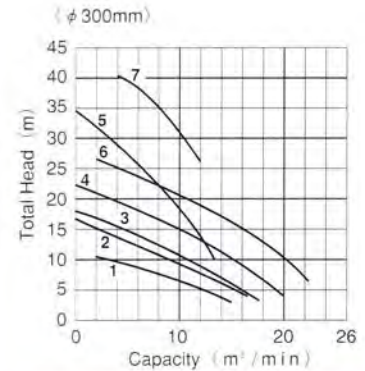

Curve No.	Model	Discharge Bore mm	Motor Output kW
1	300B615	300	15
2	300B622	300	22
3	300B630	300	30
4	300B637	300	37
5	300B445	300	45
6	300B655	300	55
7	300B475	300	75

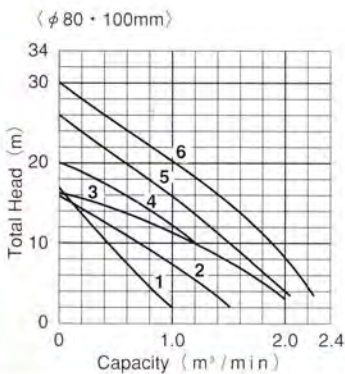

Curve No.	Model			Discharge Bore mm	Motor Output kW
	Standard	Automatic	Auto-Alternation		
1	80B21.5	80BA21.5	80BW21.5	80	1.5
2	100B42.2	100BA42.2	100BW42.2	100	2.2
3	100B43.7	100BA43.7	100BW43.7	100	3.7
4	100B43.7H	—	—	100	3.7
5	100B45.5	—	—	100	5.5
6	100B47.5	—	—	100	7.5

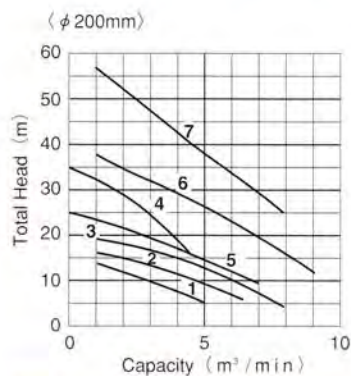

Curve No.	Model	Discharge Bore mm	Motor Output kW
1	200B47.5	200	7.5
2	200B411	200	11
3	200B415	200	15
4	200B422H	200	22
5	200B422	200	22
6	200B437	200	37
7	200B455	200	55

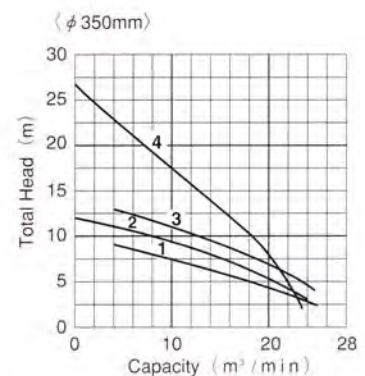

Curve No.	Model	Discharge Bore mm	Motor Output kW
1	350B822	350	22
2	350B630	350	30
3	350B637	350	37
4	350B645	350	45

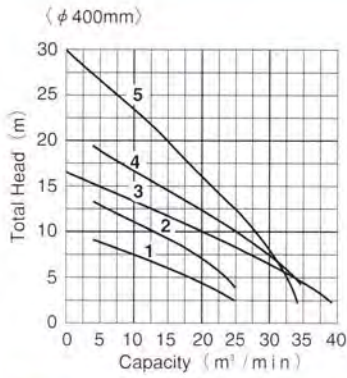

Curve No.	Model	Discharge Bore mm	Motor Output kW
1	400B822	400	22
2	400B637	400	37
3	400B645	400	45
4	400B655	400	55
5	400B675	400	75

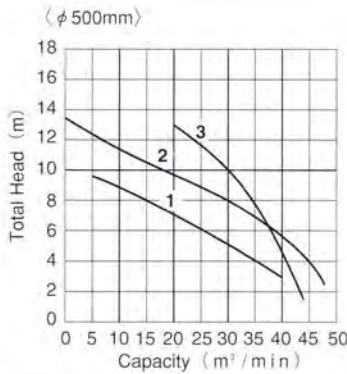

Curve No.	Model	Discharge Bore mm	Motor Output kW
1	500B1037	500	37
2	500B855	500	55
3	500B675	500	75

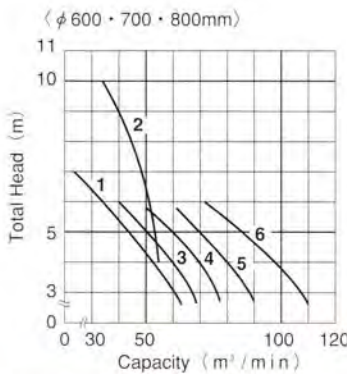

Curve No.	Model	Discharge Bore mm	Motor Output kW
1	600B1255	600	55
2	600B1085	600	85
3	700B1265	700	65
4	700B1275	700	75
5	800B1290	800	90
6	800B14110	800	110

BZ SEWAGE / WASTEWATER CHANNEL

Single channel wide opening impeller allows the pump to handle suspended solids with the diameters up to 80mm. This ensures that waste water and sewage are transferred without clogging.

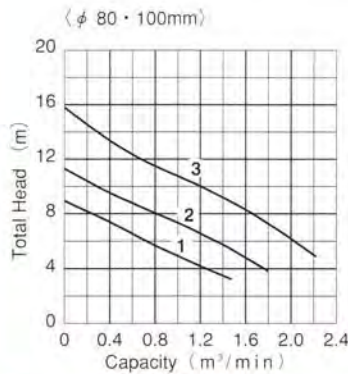

Curve No.	Model	Discharge Bore mm	Motor Output kW
1	80BZ41.5	80	1.5
2	100BZ42.2	100	2.2
3	100BZ43.7	100	3.7

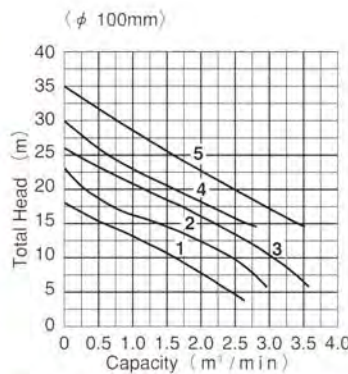

Curve No.	Model	Discharge Bore mm	Motor Output kW
1	100BZ45.5	100	5.5
2	100BZ47.5	100	7.5
3	100BZ411	100	11
4	100BZ411H*	100	11
5	100BZ415	100	15

*50Hz only

C SEWAGE / WASTEWATER CUTTER

Saw-shaped fixed blades are used in combination with a tungsten carbide blade in an impeller integrated structure. This construction ensures that fibrous foreign matter is cut up, and sewage is transferred without clogging. Automatic and auto-alternation versions are available in the region of 0.75kW to 1.5kW.

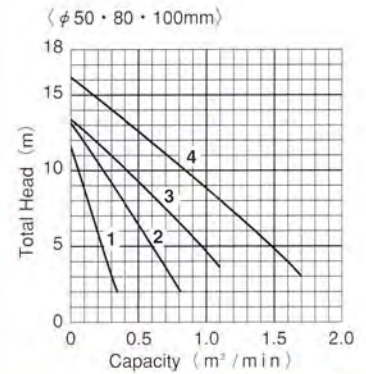

Curve No.	Model			Discharge Bore mm	Motor Output kW
	Standard	Automatic	Auto-Alternation		
1	50C2.75S	50CA2.75S	—	50	0.75
1	50C2.75	50CA2.75	50CW2.75	50	0.75
2	80C21.5	80CA21.5	80CW21.5	80	1.5
3	100C42.2	—	—	100	2.2
4	100C43.7	—	—	100	3.7

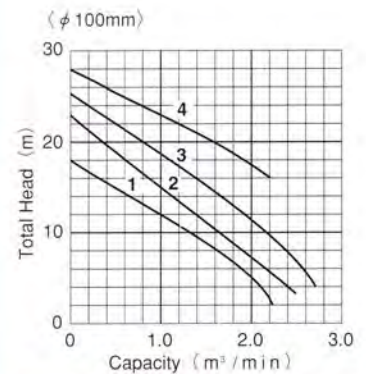

Curve No.	Model	Discharge Bore mm	Motor Output kW
1	100C45.5	100	5.5
2	100C47.5	100	7.5
3	100C411	100	11
4	100C415	100	15

DOMESTIC

OM DOMESTIC VORTEX

The main components of the OM pump are made of stainless-steel and plastic, resulting in a lightweight pump that is highly corrosion and rust-resistant. It also features the "high-gap structure", which minimizes the generation of "impeller lock" that occurs when mixed in debris is about to impede impeller rotation. An automatic version is also available.

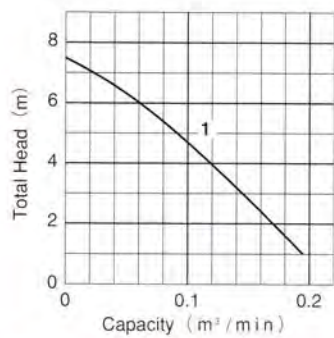

Curve No.	Model		Discharge Bore mm	Motor Output kW
	Standard	Automatic		
1	OM2	OMA2	32	0.15

Curve No.	Model			Discharge Bore mm	Motor Output kW
	Standard	Automatic	Auto-Alternation		
1	40U2.25S	40UA2.25S	40UW2.25S	40	0.25
1	40U2.25	40UA2.25	40UW2.25	40	0.25
2	50U2.4S	50UA2.4S	50UW2.4S	50	0.4
2	50U2.4	50UA2.4	50UW2.4	50	0.4
3	50U2.75	50UA2.75	50UW2.75	50	0.75
4	50U2.1.5	50UA2.1.5	50UW2.1.5	50	1.5
5	80U2.75	80UA2.75	80UW2.75	80	0.75
6	80U2.1.5	80UA2.1.5	80UW2.1.5	80	1.5
7	80U2.2.2	80UA2.2.2	80UW2.2.2	80	2.2
8	80U2.3.7	80UA2.3.7	80UW2.3.7	80	3.7

SEWAGE / WASTEWATER

PN WASTEWATER VORTEX

The main components of the PN pump are made of stainless-steel and plastic, making this an ultra-lightweight pump. Suitable for general dewatering where large solids are not likely to exist. Automatic and auto-alternation versions are available in all sizes.

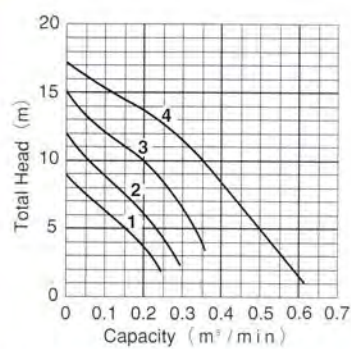

Curve No.	Model			Discharge Bore mm	Motor Output kW
	Standard	Automatic	Auto-Alternation		
1	40PN2.25S	40PNA2.25S	40PNW2.25S	40	0.25
1	40PN2.25	40PNA2.25	40PNW2.25	40	0.25
2	50PN2.4S	50PNA2.4S	50PNW2.4S	50	0.4
2	50PN2.4	50PNA2.4	50PNW2.4	50	0.4
3	50PN2.75S	50PNA2.75S	—	50	0.75
3	50PN2.75	50PNA2.75	50PNW2.75	50	0.75
4	50PN2.1.5	50PNA2.1.5	50PNW2.1.5	50	1.5

U SEWAGE / WASTEWATER VORTEX

The U pump features a vortex impeller and wide casing interior, preventing clogging by solids and fibrous foreign matters. Automatic and auto-alternation versions are also available for all sizes, 0.25kW through 3.7kW.

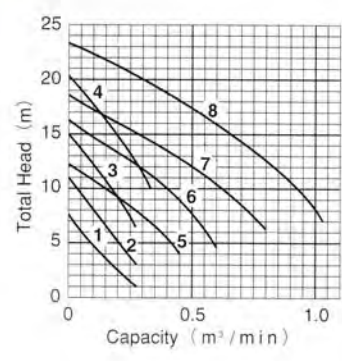

UZ SEWAGE / WASTEWATER VORTEX

The UZ pump features a vortex impeller and wide pump casing interior, and is effective in pumping and discharging water containing solids and fibrous foreign matters. Every UZ pump can pass the solid up to the same diameter as the discharge bore size.

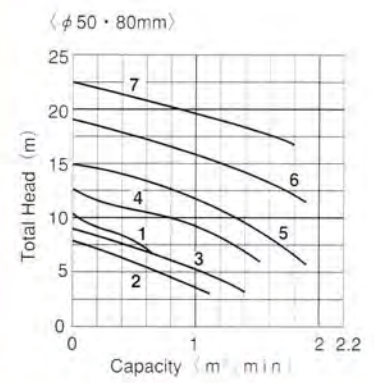

Curve No.	Model			Discharge Bore mm	Motor Output kW
	Standard	Automatic	Auto-Alternation		
1	50UZ41.5	50UA41.5	50UZW41.5	50	1.5
2	80UZ41.5	80UA41.5	80UZW41.5	80	1.5
3	80UZ42.2	80UA42.2	80UZW42.2	80	2.2
4	80UZ43.7	80UA43.7	80UZW43.7	80	3.7
5	80UZ45.5	—	—	80	5.5
6	80UZ47.5	—	—	80	7.5
7	80UZ411	—	—	80	11

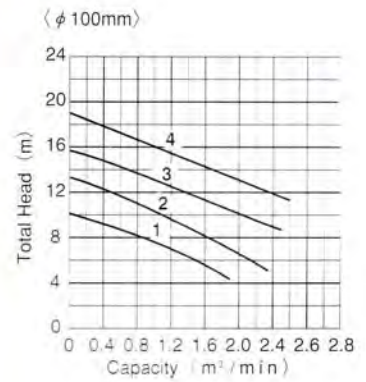

Curve No.	Model			Discharge Bore mm	Motor Output kW
	Standard	Automatic	Auto-Alternation		
1	100UZ43.7	100UA43.7	100UZW43.7	100	3.7
2	100UZ45.5	—	—	100	5.5
3	100UZ47.5	—	—	100	7.5
4	100UZ411	—	—	100	11

PU SEWAGE / WASTEWATER VORTEX

The PU is a multi-purpose pump with a vortex impeller. Use of advanced materials achieves a light and solid construction. Automatic and auto-alternation versions are also available for all sizes.

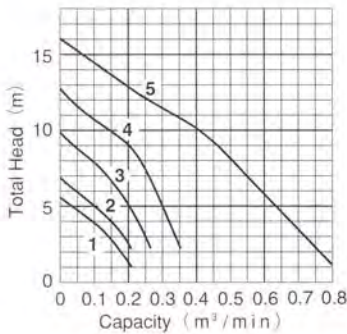

Curve No.	Model			Discharge Bore mm	Motor Output kW
	Standard	Automatic	Auto-Alternation		
1	40PU2.15S	40PUA2.15S	40PUW2.15S	40	0.15
1	40PU2.15	40PUA2.15	40PUW2.15	40	0.15
2	40PU2.25S	40PUA2.25S	40PUW2.25S	40	0.25
2	40PU2.25	40PUA2.25	40PUW2.25	40	0.25
3	50PU2.4S	50PUA2.4S	50PUW2.4S	50	0.4
3	50PU2.4	50PUA2.4	50PUW2.4	50	0.4
4	50PU2.75S	50PUA2.75S	—	50	0.75
4	50PU2.75	50PUA2.75	50PUW2.75	50	0.75
5	80PU21.5	80PUA21.5	80PUW21.5	80	1.5

MG SEWAGE / WASTEWATER GRINDER

Foreign matter is finely ground up by the built-in grinder mechanism and discharged by a vortex impeller.

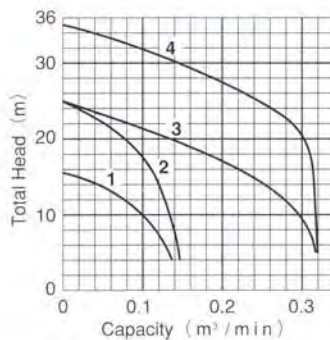

Curve No.	Model	Discharge Bore mm	Motor Output kW
1	32MG21.0S	32	1.0
1	32MG21.0	32	1.0
2	32MG21.5	32	1.5
3	50MG22.2	50	2.2
4	50MG23.7	50	3.7

CORROSIVE LIQUID

SFQ STAINLESS STEEL SEMI-OPEN IMPELLER

The SFQ pump has been developed exclusively for pumping and discharging corrosive liquids. Applying austenitic steel in all wetted parts, the SFQ pump is a highly specialist pump in term of design and materials.

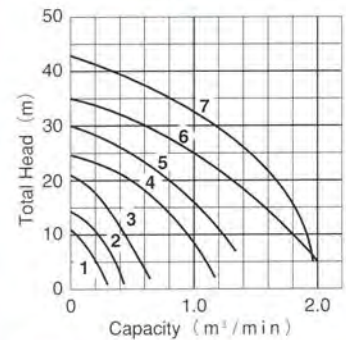

Curve No.	Model	Discharge Bore mm	Motor Output kW
1	50SFQ2.4S	50	0.4
1	50SFQ2.4	50	0.4
2	50SFQ2.75	50	0.75
3	80SFQ21.5	80	1.5
4	80SFQ23.7	80	3.7
5	80SFQ25.5	80	5.5
6	80SFQ27.5	80	7.5
7	80SFQ211	80	11

SQ STAINLESS STEEL SEMI-OPEN IMPELLER

Being made of 304 stainless-steel, this compact submersible pump is for use with slightly corrosive liquids. A harmless white oil is used as the lubricating oil. Automatic type is available for single-phase only.

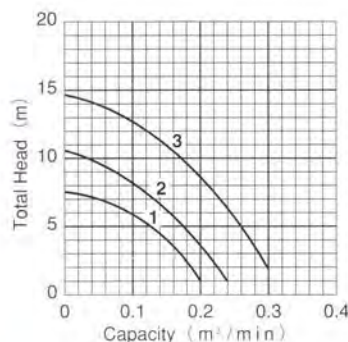

Curve No.	Model		Discharge Bore mm	Motor Output kW
	Standard	Automatic		
1	40SQ2.25S	40SQA2.25S	40	0.25
1	40SQ2.25	—	40	0.25
2	50SQ2.4S	50SQA2.4S	50	0.4
2	50SQ2.4	—	50	0.4
3	50SQ2.75	—	50	0.75

CORROSIVE LIQUID

BQ STAINLESS STEEL CHANNEL IMPELLER

Based on B series, whole surfaces get in touch with liquid are made by stainless-steel casting. Wide opening channel impeller and shaver mechanism of the suction cover performs smooth dewatering even sewage contains suspended solids.

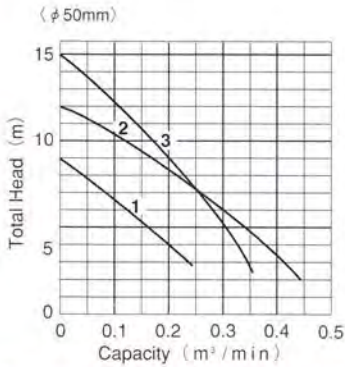

Curve No.	Model	Discharge Bore mm	Motor Output kW
1	50BQ2.4	50	0.4
2	50BQ2.75	50	0.75
3	50BQ2.75H	50	0.75

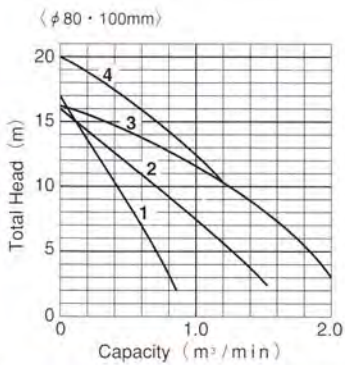

Curve No.	Model	Discharge Bore mm	Motor Output kW
1	80BQ21.5	80	1.5
2	100BQ42.2	100	2.2
3	100BQ43.7	100	3.7
4	100BQ43.7H	100	3.7

CQ STAINLESS STEEL CUTTER IMPELLER

Based on C series, whole surfaces get in touch with liquid are made by stainless-steel casting. Wide opening channel impeller with cutter mechanism makes powerful dewatering even the water contains suspended solids and fibrous matters.

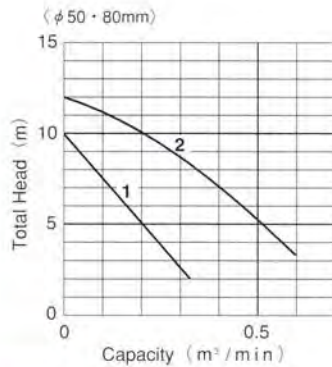

Curve No.	Model	Discharge Bore mm	Motor Output kW
1	50CQ2.75	50	0.75
2	80CQ21.5	80	1.5

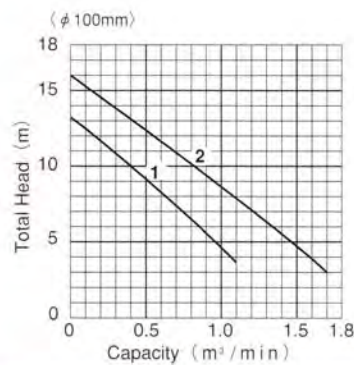

Curve No.	Model	Discharge Bore mm	Motor Output kW
1	100CQ42.2	100	2.2
2	100CQ43.7	100	3.7

SEA WATER

TM TITANIUM VORTEX IMPELLER

The all wetted parts are made of titanium or resin. Far stronger than stainless-steel against sea water, the TM series fits for marine use. Automatic version is available in all sizes.

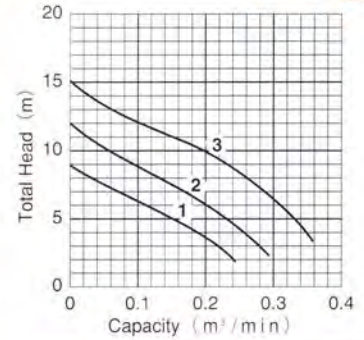

Curve No.	Model		Discharge Bore mm	Motor Output kW
	Standard	Automatic		
1	40TM2.25S	40TMA2.25S	40	0.25
1	40TM2.25	40TMA2.25	40	0.25
2	50TM2.4S	50TMA2.4S	50	0.4
2	50TM2.4	50TMA2.4	50	0.4
3	50TM2.75	50TMA2.75	50	0.75

KTX EXPLOSION PROOF SEMI-OPEN IMPELLER

The pump has been officially approved by Japan's Technical Institute of Industrial Safety, Ministry of Labour, for use in the hazardous areas.

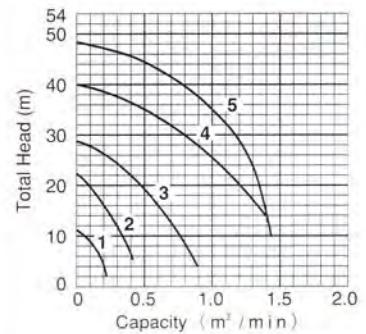

Curve No.	Model	Discharge Bore mm	Motor Output kW
1	50KTX2.4S	50	0.4
2	50KTX21.5	50	1.5
3	80KTX23.7	80	3.7
4	100KTX27.5	100	7.5
5	100KTX211	100	11

PSF FOR DEFORMING CLOSED IMPELLER

The PSF pump features the highest head in this class. Stainless-steel and plastic are used in all wetted parts.

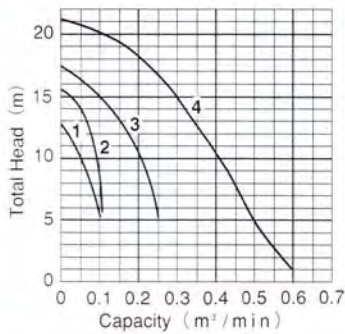

Curve No.	Model	Discharge Bore mm	Motor Output kW
1	40PSF2.25S	40	0.25
1	40PSF2.25	40	0.25
2	40PSF2.4S	40	0.4
2	40PSF2.4	40	0.4
3	50PSF2.75	50	0.75
4	50PSF2.15	50	1.5

SF HIGH HEAD SEMI-OPEN IMPELLER

The SF pump is compact, lightweight and easy-to-handle. The pump is ideal for high head applications.

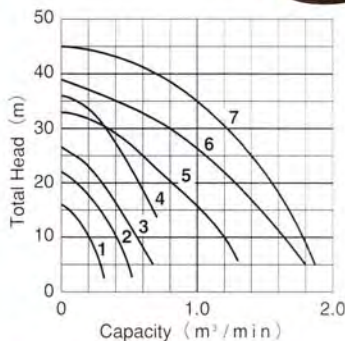

Curve No.	Model	Discharge Bore mm	Motor Output kW
1	50SF2.75	50	0.75
2	50SF2.15	50	1.5
3	50SF2.2.2	50	2.2
4	50SF2.3.7	50	3.7
5	80SF2.5.5	80	5.5
6	80SF2.7.5	80	7.5
7	80SF2.11	80	11

FSP SCUM SKIMMER

The skimmer incorporates jet injector (suction mechanism) for efficiently collecting scum.

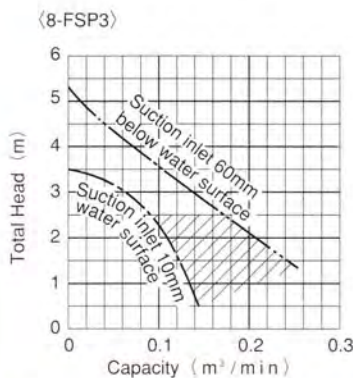
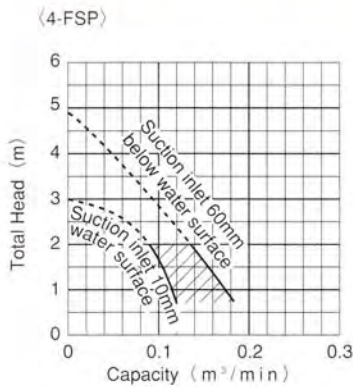

Model	Discharge Bore mm	Motor Output kW
4-FSP	50	0.4
8-FSP3	50	0.75

FHP DECANTING PUMP

The sludge surface monitoring mechanism used in the FHP pump ensures that only supernatant water is discharged without any entrapment of sediment.

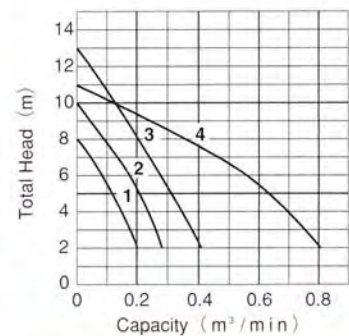

Curve No.	Model	Discharge Bore mm	Motor Output kW
1	FHP2-3	40	0.25
1	FHP2-3T	40	0.25
2	FHP-4	50	0.4
2	FHP-4T	50	0.4
3	FHP3-8T	50	0.75
4	FHP2-15T	80	1.5

BER SUBMERSIBLE EJECTOR

This submersible aerator incorporates a pump and ejector mechanism so that both agitation and aeration can be carried out simultaneously. The BER aerator features high oxygen dissolution efficiency and a non-clog shaver mechanism.



● Air Emission Volume -Water Depth Curve

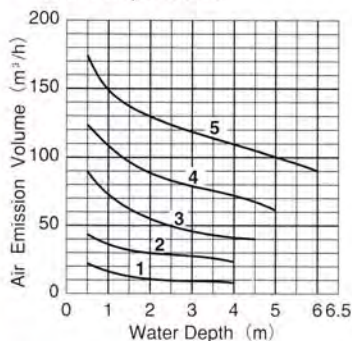

● Oxygen Dissolution Volume -Water Depth Curve

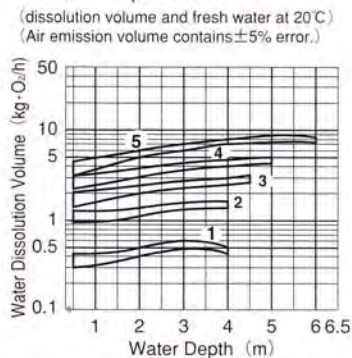

Curve No.	Model	Dia of Air Pipe mm	Motor Output kW
1	8-BER4	25	0.75
2	15-BER3	32	1.5
3	22-BER5	50	2.2
4	37-BER5	50	3.7
5	55-BER5	50	5.5

Curve No.	Model	Dia of Air Pipe mm	Motor Output kW
1	8-TRN3	32	0.75
2	15-TRN3	32	1.5
3	22-TRN3	50	2.2
4	37-TRN3	50	3.7
5	55-TRN3	50	5.5
6	75-TRN3	80	7.5
7	110-TRN3	80	11

TR SUBMERSIBLE AERATOR

The TR model is a submersible aerator that applies an innovative principle of operation. Negative pressure is created by the combination of rear blade action and the stream generated by a special open impeller. Air sucked in by this negative pressure creates a convective agitation effect. This results in extremely high oxygen dissolution efficiency and a uniform concentration at the internal MLSS.



● Air Emission Volume -Water Depth Curve

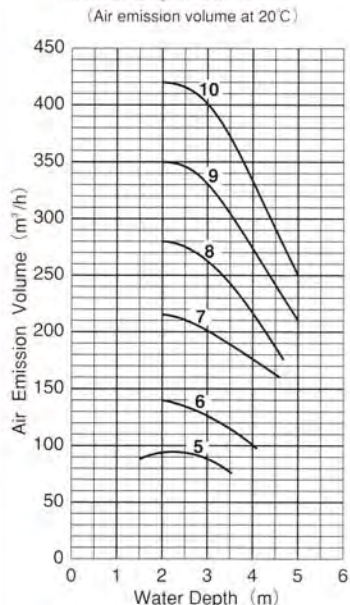

(Air emission volume at 20°C)

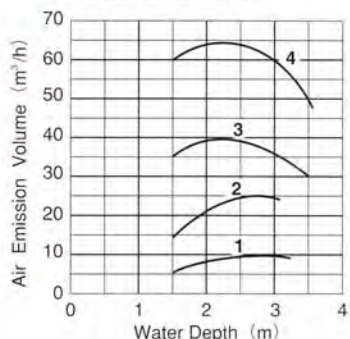

(Air emission volume at 20°C)



● Oxygen Dissolution Volume -Water Depth Curve

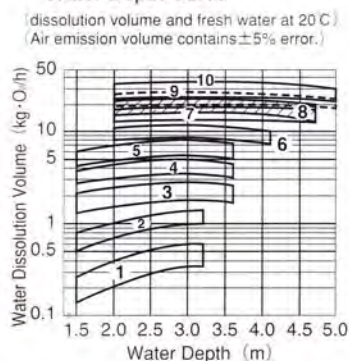

Curve No.	Model	Dia of Air Pipe mm	Motor Output kW
1	8-TR3	32	0.75
2	15-TR3	32	1.5
3	22-TR3	50	2.2
4	37-TR3	50	3.7
5	55-TR3	50	5.5
6	75-TR3	80	7.5
7	110-TR3	80	11
8	150-TR3	80	15
9	190-TR2	100	19
10	220-TR2	100	22

TRN SUBMERSIBLE AERATOR NON-CLOG IMPELLER

The TRN is a modified version of the TR aerator, and is equipped with a non-clog impeller for aeration tanks in which large quantities of impurities are mixed.



● Air Emission Volume -Water Depth Curve

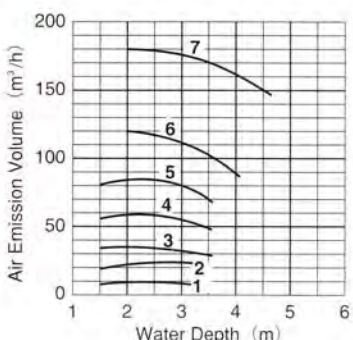

● Oxygen Dissolution Volume -Water Depth Curve

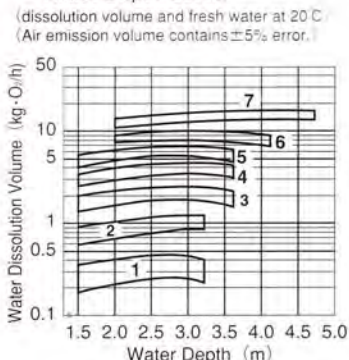

NR — Submersible Blower



As both the motor portion and blower are sealed together and can be submerged, you can install NR in a flow control tank or other pit. By this feature, it is not required to find a space on the ground. Moreover, you can expect a good motor cooling and silent operation.

TAR — Submersible Air Mixer



Powerful and steady water flow by the axial flow impeller makes very fine bubbles and performs wide circulation. Air volume can be controlled from zero to maximum by a valve. TAR is also suitable for deep aeration tank.

KM·KE·KS — Bar Screen



Automatic pretreatment equipment to remove the solid before aeration. Bar spacing is from 1mm to 50mm. There are front screen type with rear scraping tooth and rear screen type with gathering rake.

SD — Screening Equipment with dehydrator



Combination of bar screen and screw type dehydrator. The dehydrator operates intermittently according to the volume of scraped suspended solids.

We are the specialist of water

DS — Dehydrator



Most compact multi-disk type dehydrator for organic sludge. It is suitable to use with automatic operation.

RS(S·A·R) — Blower



Horizontal root type rotary blower with silent three blade rotor. Innovative helical outlet port solves violent impact and pulsation noise.

PRM — Self cleaning system for lift station



SSP — Submersible Axial/Mixed Flow Pump

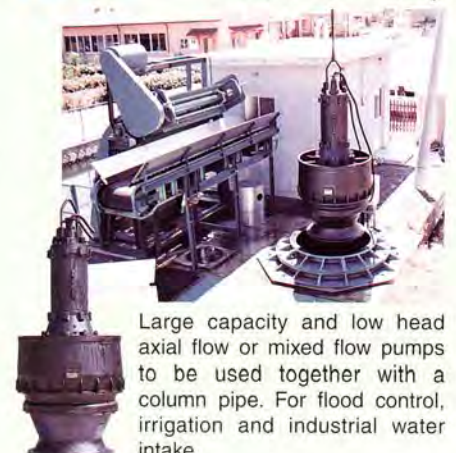

Large capacity and low head axial flow or mixed flow pumps to be used together with a column pipe. For flood control, irrigation and industrial water intake.

DX — Automatic kitchen waste transfer system



Kitchen waste such as vegetable garbage are gathered and transferred in a pipe-line by vacuum. This is the total system of hopper, tank unit, solid separator, deodorizer, vacuum transfer machine, and control panel.

Tsurumi's manhole pump unit with pre-rotation self cleaning system that minimizes the volume of sludge and scum to be left, thus solving the problem of bad smell.

Transcending Language and Borders

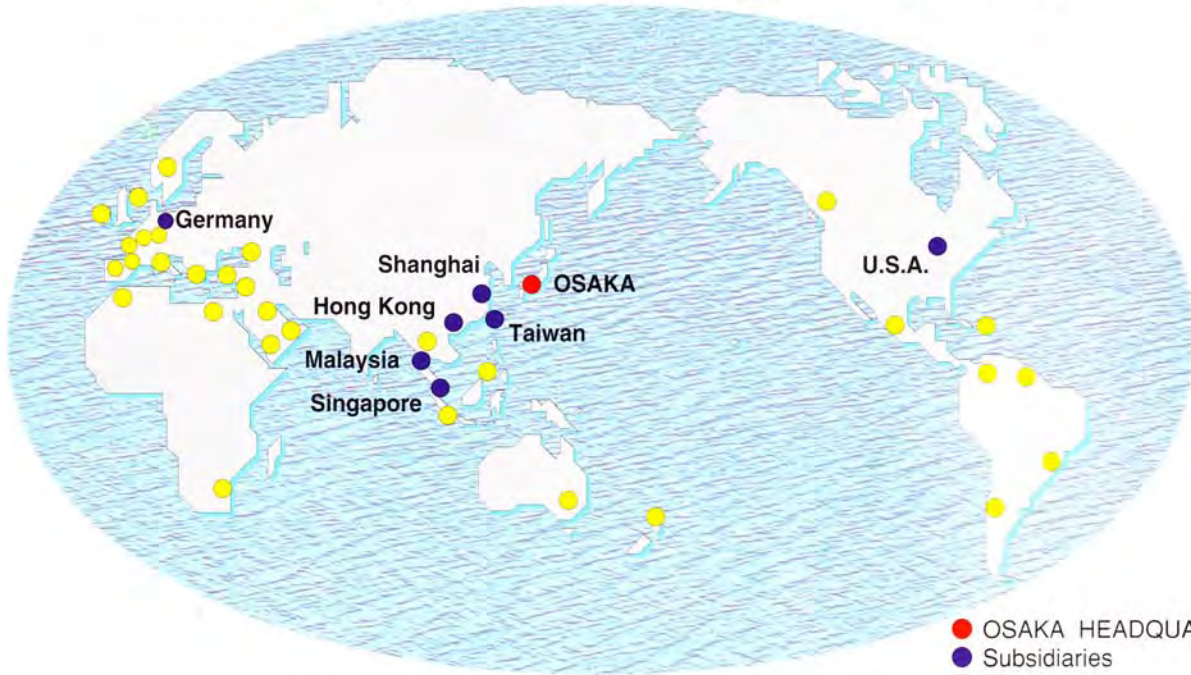

● OSAKA HEADQUARTERS
● Subsidiaries
● Distributors

TSURUMI MANUFACTURING CO.,LTD.

OSAKA HEADQUARTERS

16-40, 4-Chome, Tsurumi, Tsurumi-ku, Osaka,
 JAPAN 538-8585
 Phone 81-6-6911-7271 Fax 81-6-6911-0100
<http://www.tsurumipump.co.jp>
 E-mail : intsales@tsurumipump.co.jp

KYOTO PLANT

1-1, Kaminaranagaikae, Yawata-city, Kyoto,
 JAPAN 614-8163
 Phone 81-75-971-0831 Fax 81-75-971-1316

YONAGO PLANT

2700, Yomi-cho, Yonago-city, Tottori,
 JAPAN 683-0851
 Phone 81-859-29-0811 Fax 81-859-24-0602



U.S.A.

TSURUMI (AMERICA) INC.
 845 N. Dillon Dr. Wood Dale ILL. 60191, U.S.A.
 Phone 1-630-766-5900 Fax 1-630-766-6445

GERMANY

TSURUMI (EUROPE) GMBH
 Heltorfer Str. 16, D-40472 Dusseldorf, F.R. Germany
 Phone 49-211-417-9373 Fax 49-211-479-1429

HONG KONG

H&E TSURUMI PUMP CO., LTD.
 RM 1101, Chow Sang Sang Bldg.
 229, Nathan Road, Kowloon, Hong Kong
 Phone 852-2730-7208 Fax 852-2730-6531

SINGAPORE

TSURUMI (SINGAPORE) PTE. LTD.
 26, Hillview Terrace, Singapore, 669237
 Phone 65-6760-8338 Fax 65-6760-1268

TAIWAN

TSURUMI PUMP TAIWAN CO., LTD.
 No.67, Fengtian st., Bade City, Tao-yuan,
 334 Taiwan
 Phone 886-3-368-9830 Fax 886-3-368-9832

MALAYSIA

TSURUMI PUMP(MALAYSIA)SDN. BHD.
 No.22 Jalan PJU 3/41, Sunway Damansara,
 47810 Petaling Jaya, Malaysia
 Phone 60-3-7803-3373 Fax 60-3-7806-3748

CHINA

TSURUMI (SHANGHAI) CO., LTD.
 Room 1201 Building D, No.80 Caobao rd.,
 Xuhui Shanghai 200235, China
 Phone 86-21-6432-6010 Fax 86-21-6432-6013

We reserve the right to change the specifications and designs for improvement without prior notice.

**TSURUMI
 MANUFACTURING CO.,LTD.**

PT. LUKES INDONESIA

Lindeteves Trade Center Lt UG, Blok B1 No. 6
 Jalan Hayam Wuruk, Jakarta - Indonesia
 Phone : 021 - 6231 7842, 628 5144
 Fax : 021 - 6231 0499
 email : lukes@cbn.net.id





Submersible Wastewater Pumps **Semi-open Impeller**

SF



Submersible cast-iron drainage pumps

Ideal for high-head pumping plus defoaming at sewage treatment plants

Motor protective device

All Tsurumi pumps have a built-in motor protection device. A circle thermal protector (CTP) is incorporated in Tsurumi pumps with a direct-on-line starting motor. The CTP is installed in the motor housing and it directly cuts the motor circuit if excessive heat builds up or an over-current is caused by an electrical or mechanical failure.

Pumps with a star-delta starting motor have three miniature thermal protectors (MTPs) imbedded in each winding of the 3-phase motor. These MTPs are connected in series, with their wires led out of the motor. Should the winding's temperature rise to the actuating level, the bimetal strip opens to cause the control panel to shut down the power supply.

Oil Lifter (Pat. Pending)

The Oil Lifter is designed to stabilize the mechanical seal function. Utilizing the rotational energy of the shaft seal, the Oil Lifter continues to supply lubricant to the top seal faces even if the lubricant falls below the rated volume. This amazingly simple device not only turns wasted energy into added protection but also doubles the life expectancy of the mechanical seal and also the maintenance term.



Anti-wicking cable entry

Every cable has an anti-wicking block at the cable entry section of the pump. This mechanism is such that a part of each conductor is stripped back and the part is sealed by molded rubber or epoxy potting which has flowed in between each strand of the conductor. This unique feature prevents wicking under the strands of the conductor itself.

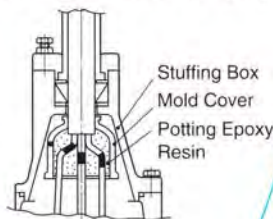

Motor

This induction motor is a dry, squirrel-cage type. Housed in a cast-iron watertight casing, the motor conforms to insulation class E and drives all standard pumps in ambient temperatures of up to 40°C.

Mechanical seal

All pumps are provided with a silicon-carbide dual inside mechanical seal that is located completely out of the drainage and is running in an oil-filled chamber. The seal has two major advantages: it eliminates spring failure caused by corrosion, abrasion and/or fouling which can prevent the seal faces from closing properly. Also, the seal prevents the loss of cooling energy to the bottom seal faces during run-dry conditions that causes the bottom seal to fail.

Seal-pressure relief system

Tsurumi pumps with capacity of 5.5 kW or larger have a seal-pressure relief system. This system features an independent pump casing built separately from the oil casing which incorporates the mechanical seal. An intermediate chamber, opened to the outside, is installed between the pump casing and the oil casing. Thanks to this configuration, the mechanical seal is only exposed to static (submergence) pressure without the pumping pressure operating on it. This prevents the mechanical seal from premature wear under the high-head pumping condition.

Guide rail fittings (standard equipment)

Guide rail fittings readily connect/disconnect the pump to/from the piping system only by lifting up and down the pump. This simplifies regular maintenance and inspection, which will no longer require entry into the sump. The SF-series pumps with capacity of 1.5 kW to 11 kW, preceded by TOS in the model code, are available with guide rail fittings. For more information about model codes, please see the specifications table.

Replaceable wear parts

All these pumps are designed so that their wear parts, such as the impeller and the suction cover, can be replaced by new ones very easily.

Applications:

- Defoaming spray and treated-water draining at sewage treatment plants;
- Dewatering and transferring industrial wastewater;
- Draining storm or surface water;
- Other high-head pumping jobs.

Composition of model code

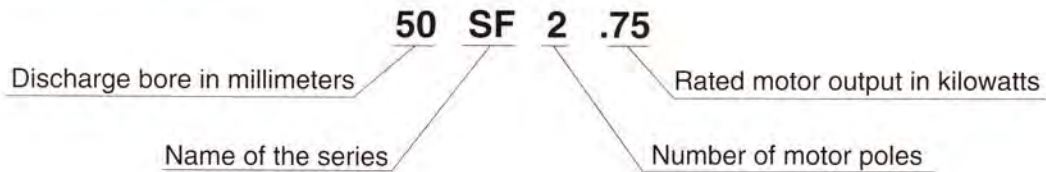

Performance curves

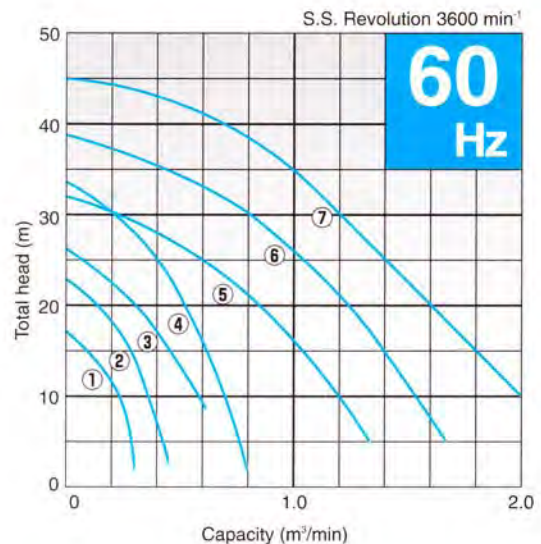
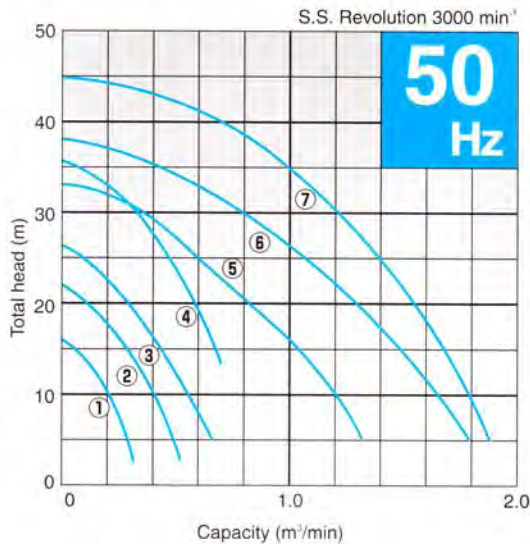

Specifications

Curve No.	Discharge Bore mm	Free Standing	Guide Rail Fitting	Motor Output KW	Phase	Revolution 50 Hz/60 Hz min ⁻¹	Starting Method	Impeller Passage mm	Standard Cable Length m	Cable Code	Dimension L x H mm		Dry Weight kg	
											Free Standing	Guide Rail Fitting	Free Standing	Guide Rail Fitting
1	50	50SF2.75	(TOK)	0.75	Three	3000/3600	D.O.L.	11/10	6	A	253×375	—	20	—
2	50	50SF21.5	TOS50SF21.5	1.5	Three	3000/3600	D.O.L.	11/10	6	A	421×494	637×542	33	33
3	50	50SF22.2	TOS50SF22.2	2.2	Three	3000/3600	D.O.L.	7.5	6	C	466×534	648×582	49	49
4	50	50SF23.7	TOS50SF23.7	3.7	Three	3000/3600	D.O.L.	7.5	6	C	466×537	648×585	56	55
5	80	80SF25.5	TOS80SF25.5	5.5	Three	3000/3600	D.O.L.	15/19	8	H	635×824	808×855	125	122
6	80	80SF27.5	TOS80SF27.5	7.5	Three	3000/3600	D.O.L.	19/21	8	I	635×824	808×855	128	125
7	80	80SF211	TOS80SF211	11	Three	3000/3600	Star-Delta	22	8	R	635×872	808×903	147	144

Notes:

When an SF pump is ordered with guide-rail fitting*, the following accessories will come with the pump as standard equipment (*Please attach TOS to its model code.):

- 1× Duckfoot Bend
 - 1× Guide Support
 - 1× Guide Hook
 - 1× Lifting chain (5 m long) with shackle
- (Foundation bolts are available as an optional accessory.)

※ weights of pump only

Cabletyre Cable

Code	Pcs/unit	Core × mm ²	Dia. mm	Material
A	1	4 × 1.25	11.1	PVC Sheath
C	1	4 × 2	11.8	
H	1	4 × 3.5	14.1	
I	1	4 × 5.5	16.8	
R	3	4 × 3.5	14.1	Chloroprene Sheath
		3 × 3.5	12.9	
		2 × 2	10.6	

Note:

A thicker cable may be supplied depending on the power supply voltage.

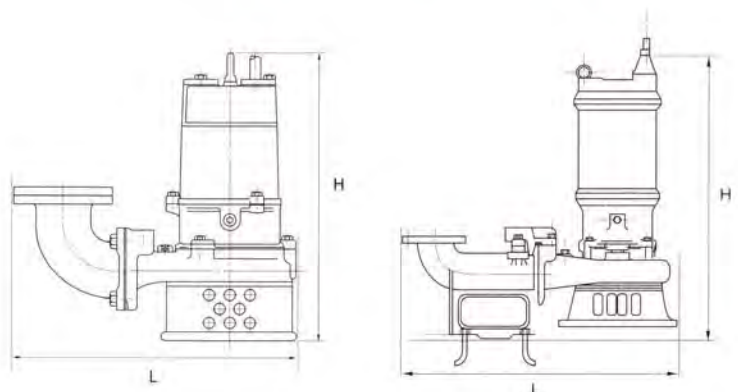

Tsurumi float switch

Model MC-2 is a heavy-duty float switch with a shock absorber. Equipped with a high-grade micro-switch, the float assures trouble-free pump operation in the sewage or liquid containing suspended solids and floating scum. The MC-2 has both normally open and normally close contacts as standard. You can select either of the two contacts as required.



Model RF-5 is an economy float switch which can detect upper/lower limit water levels with a single float. The snap on-off action ensures stable pump operation in the clean or waste water containing suspended solids or oil and fat.



TOK guide rail fittings (option)

Tsurumi provides TOK-type guide rail fittings, as an option, for Model 50SF2.75. The fittings connect/separate the pump to/from piping only by lifting up and down the pump; no need to enter the sump for maintenance.



The TOK is supplied with the following contents:

- 1 × Duckfoot Bend
- 1 × Upper Guide Support
- 1 × Guide Hook
- 1 × Lifting Chain, 4m long
- 1 × Rubber Bellows

(The foundation bolts, two numbers are required, are not included.)

Special Versions

Sacrificial anode

The sacrificial anode makes use of a battery phenomenon generated by the difference in the electric potentials of two different materials when they are dipped in an electrolytic liquid. Metal, which has a higher electric potential, dissolves first thus protecting the pump body from corrosion.

High temperature liquid

Standard pumps are designed for continuous running at a maximum ambient temperature of 40 °C. In addition to these, Tsurumi can provide pumps for operation at higher liquid temperature upon request. Refitting for operation at higher temperature involves modification of not only the insulation of motor windings but also several components. Two high - temperature operation models are available - the Rank 60 for operation in liquid up to 60 °C and the Rank 90 for operation in liquid up to 90 °C. Consult your dealer for more details. (These special versions are not available for some pump models.)

Non-standard materials

Tsurumi also offers pumps with essential components, such as the impeller, pump casing and suction cover, made of non-standard materials. Select from stainless steel, chromium iron and bronze to suit specific requirements. Please consult your dealer for more information.

We reserve the right to change the specifications and designs for improvement without prior notice.

**TSURUMI
MANUFACTURING CO.,LTD.**

PT. LUKES INDONESIA

Lindeteves Trade Center Lt UG, Blok B1 No. 6
Jalan Hayam Wuruk, Jakarta - Indonesia
Phone : 021 - 6231 7842, 628 5144
Fax : 021 - 6231 0499
email : lukes@cbn.net.id

