

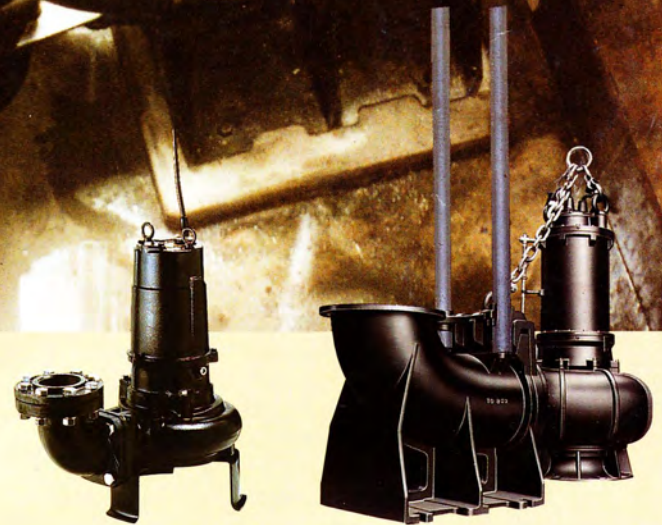

Submersible Sewage Pumps

# Channel Impeller

# B

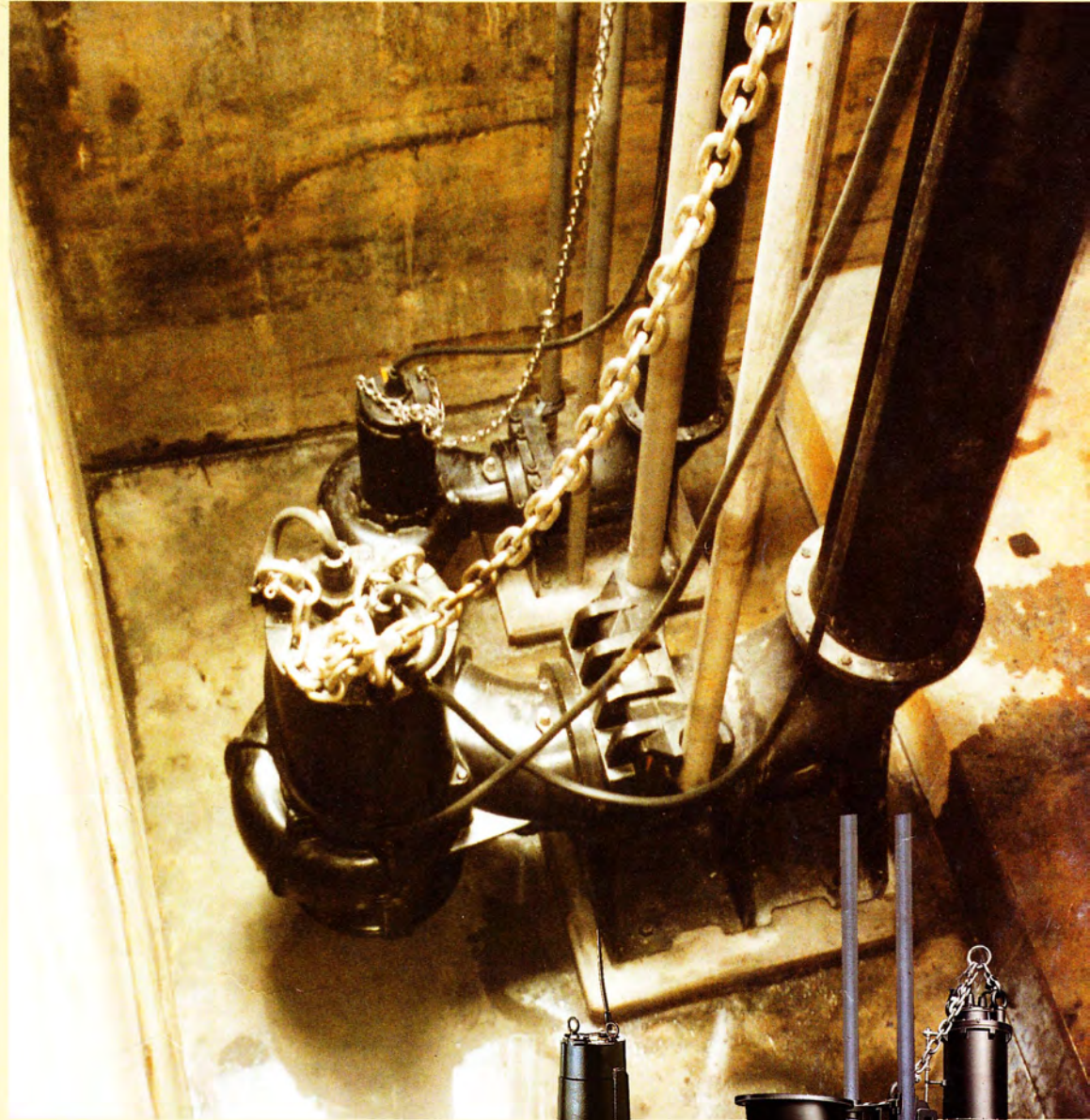



# Tsurumi B-series, the basic sewage pumps with channel foreign matter-related trouble. Years of know-how are built

## Cable Entry

Every cable has an anti-wicking block at the cable entry section of the pump. This mechanism is such that a part of each conductor is stripped back and the part is sealed by molded rubber or epoxy potting which has flowed in between each strand of the conductor. This unique feature prevents wicking under the strands of the conductor itself.

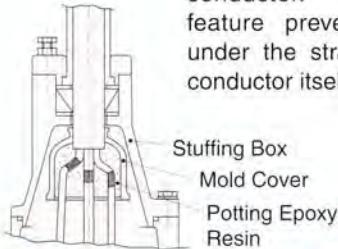

## Motor Protector

Each pump up to 7.5kW as standard has a built in auto-cut, self-resetting Circle Thermal Protector (CTP). Integrated in the motor housing, the CTP directly cuts the motor circuit if excessive heat builds up or an overcurrent caused by an electrical or mechanical failure occurs.



(Circle thermal protector)

## Motor

The motor is dry type, squirrel cage induction motor, housed in a watertight housing. The insulation class is B, E or F. In each of these insulation class, all the standard pumps can be used under the ambient temperature of 40°C.

## Mechanical Seal

All pumps are provided with a Silicon Carbide dual inside mechanical seal that is located completely out of the pumpage, running in an oil-filled chamber. The advantages of this seal are two-fold, it eliminates spring failure caused by corrosion, abrasion or fouling which prevents the seal faces from closing properly, and prevents loss of cooling to the bottom seal faces during run-dry conditions which causes the bottom seal to fail.

## Oil Lifter (Patent Pending)

The OIL LIFTER is a lubrication equipment for the mechanical seal, designed to stabilize the function of the seal. Utilizing the rotational energy of the shaft seal, it supplies lubricant to the top seal faces even if the lubricant reduces below the rated volume. The OIL LIFTER turns the wasted energy into added protection and doubles the life expectancy of the mechanical seal and also the maintenance term.

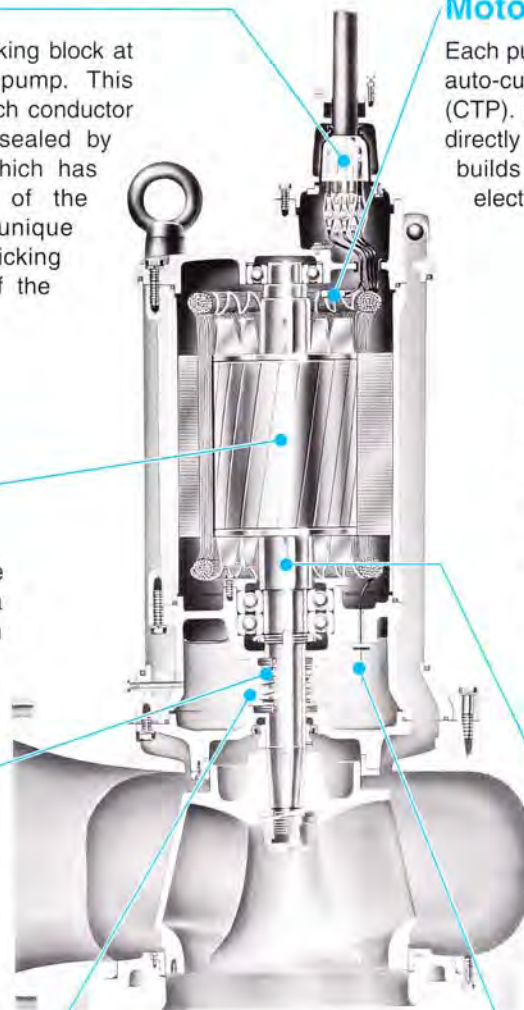

Miniature Thermal Protectors (MTPs) are imbedded in the winding of the pumps of star delta starting. These MTPs are connected in series, and their wires are led out of the motor. Should the winding temperature rise to the actuating temperature, the bimetal strip opens to cause the control panel to shut the power supply.

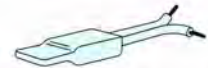

(Miniature thermal protector)

## Shaft

A high tensile stainless steel is used for all pumps. It is designed to have an adequate strength for the transmission of the full load.

The shaft is supported by C3 type, high quality deep groove ball bearings.

## Impeller

An impeller having a wide channel extending from inlet to exit, which prevents internal clogging by solids sucked in via the inlet.



## Leakage Sensor

A stainless-steel probe type leak sensor is standardized for large pumps (22kW and over).



## COMPOSITION OF THE MODEL NAME

**100 B A 6 3.7 S H**

Discharge Bore in mm

Name of the Model

Operation Sub Code

None : None Automatic Operation  
A : Automatic Operation  
W : Auto-Alternation Operation

Poles of Motor

Sub Code for Pumping Head

H : High head  
M : Medium head  
L : Low head

Phase of Motor

S : Single phase  
none : Three phase

Motor Output in kW



# impeller that minimize clogging, winding, and other into very part of the pumps for highly reliable operation.

## GUIDE RAIL TYPE

### TOS

We recommend using the Tsurumi "TOS" guide rail fitting system with pumps. This system connects the pump to and from the piping easily just by lowering and hoisting the pump, allowing easy maintenance and inspection without the need to enter the sump.



### TS

This compact guide rail fitting system is ideal for installing on prefabricated lift stations. Its discharge flange is compatible with major flange standards including ANSI 150lb, BS PN10, and DIN PN10. Four models are available and can be used on Tsurumi cast-iron pumps in the 50 mm through 100 mm discharge bore range.



## DRY PIT TYPE

The advantage of dry pit type pump is that it will not be damaged by a flooding of water, as it is constructed by a submersible pump.

Tsurumi can provide the dry pit type pumps as option for the whole range of B series pumps.

Durable motor with effective water cooling jacket assures the pump continuous running without overheating.



## AUTOMATIC TYPE

The Tsurumi automatic type pump has an integral control circuit and two float switches operated at a low voltage. As the pump has a Circle Thermal Protector (CTP) integrated into the motor to protect the motor from overload or overheating, it is not required to provide an extra motor protection circuit in the starter panel.

This type can be identified by the suffix "A". Refer to the specification table for availability and model numbers.



## AUTO-ALTERNATION TYPE

Tsurumi offers auto-alternation type pumps as well as the standard automatic pumps. The automatic alternation operation can be achieved by the combination of a parent pump (3 floats) and a standard automatic pump (2 floats), and this enables each pump to operate alternately without control panel.

### How the Auto-alternation Type Works

- Operation is enabled by merely connecting the power supply.

#### Primary Operation



- 1 Float 3 operates, and pump B starts to discharge water.

#### Secondary Operation

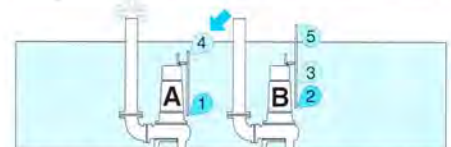

- 1 Start float 4 of pump A operates to start water discharge. The pump ends primary operation, and stops operating.

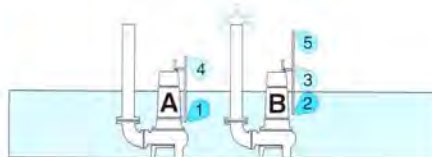

- 2 Water is discharged (water level falls).

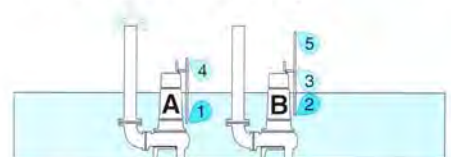

- 2 Water is discharged (water level falls).

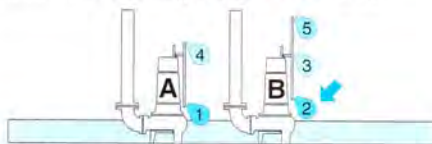

- 3 Stop float 2 of pump B operates to end water discharge. At this time, alternation start float 3 of pump B rests for one discharge operation.



- 3 Stop float 1 of pump A operates to end water discharge. At the same time, start float 3 of pump B becomes ready for operation.

- ※ Primary operation and secondary operation are repeated alternately.
- ※ Both primary and secondary operations are performed simultaneously when water has risen to an abnormal level.

The parent pump can be identified by the designation "W". It is available in the same output range of the standard automatic pumps.



# B-series is the Basic of Submersible Sewage Pumps using for all the society fundamentals. Durable and High Quality Products can be used for various kinds of field.

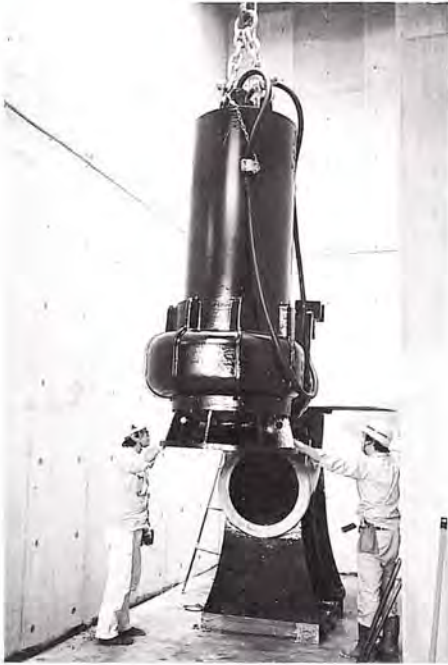

B-series pumps are working in many sewage treatment plants throughout Japan because of their excellent reputations. As durable motor is tough enough against frequent ON/OFF, automatic unattended operation by central control is available.



As it is silent during operation owing to its underwater operation, B-series pumps are often used at the basement of buildings in the city area.

Even if the condition is very severe, sewage pumps are required to have high and steady performance. Tsurumi B-series pumps can give a solution for this problem.



While in overseas, Tsurumi has a lot of sales records with B-series pumps, too.

Several inventions adopted by the idea seeking better handling produces ease of maintenance and repair for users comparing to other manufacturers. Because of this, Tsurumi pumps have good reputation as the most intimate pump in the world.





In the shipyard, B-series pumps, which are operated by fully-automatic control, work for level control and dry up. For sea water, sacrificial anodes are applied.

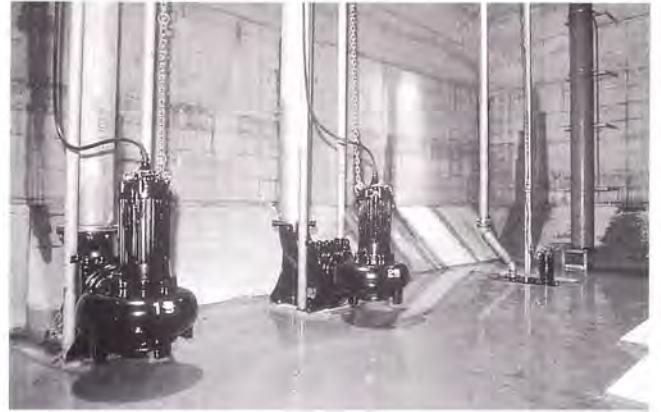
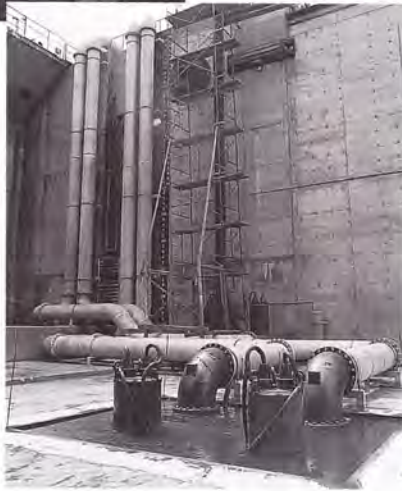

Enough absorption can not be expected in the city center where the ground is covered by concrete. Occasional flood occurs often when a local heavy rain comes. In such case, large capacity B series pumps play an active role.



B-series pumps being used for a temporary installation during rainy season. It is used to pump up water of branch river to the main stream when the water level of main stream becomes higher than that of the branch river.



Because of its robust construction, B-series pumps are sometimes used for dewatering in construction site. Compact shape allows high portability comparing against the horizontal pump which requires a firm installation foundation work. In such case, some pump parts are changed its material into harder materials.

## Dimensions

Free Standing

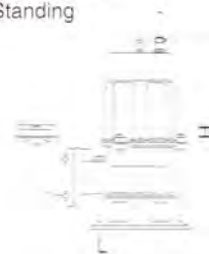

## Performance Curves

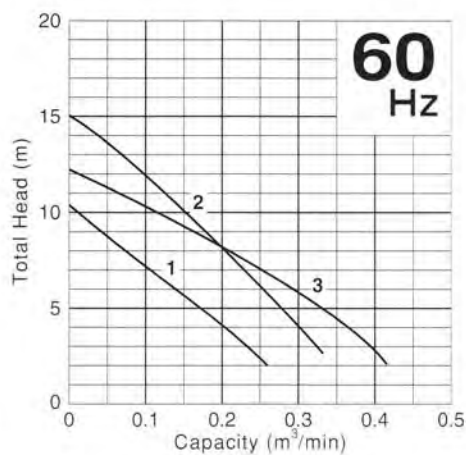
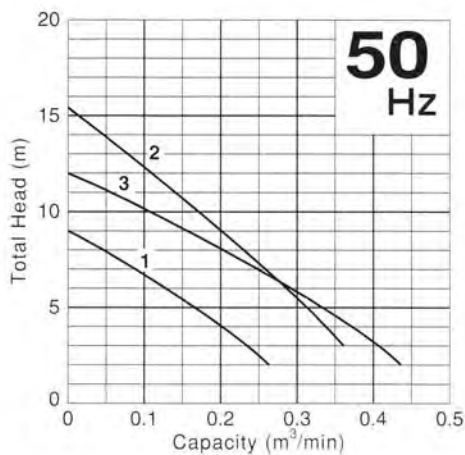

Guide Rail Fitting



TS



## Specifications 50mm

Curve No.	Discharge Bore mm	Standard Model			Automatic Model			Auto-Alternation Model		
		Free Standing	Guide Rail Fitting		Free Standing	Guide Rail Fitting		Free Standing	Guide Rail Fitting	
			TOS	TS		TOS	TS		TOS	TS
1	50	50B2.4	TOS50B2.4	TS50B2.4	—	—	—	—	—	—
2	50	50B2.75S	TOS50B2.75S	TS50B2.75S	50BA2.75S	TOS50BA2.75S	TS50BA2.75S	—	—	—
2	50	50B2.75H	TOS50B2.75H	TS50B2.75H	—	—	—	—	—	—
3	50	50B2.75	TOS50B2.75	TS50B2.75	—	—	—	—	—	—

## Specifications 80 · 100mm

Curve No.	Discharge Bore mm	Standard Model			Automatic Model			Auto-Alternation Model		
		Free Standing	Guide Rail Fitting		Free Standing	Guide Rail Fitting		Free Standing	Guide Rail Fitting	
			TOS	TS		TOS	TS		TOS	TS
1	80	80B21.5	TOS80B21.5	TS80B21.5	80BA21.5	TOS80BA21.5	TS80BA21.5	80BW21.5	TOS80BW21.5	TS80BW21.5
2	100	100B42.2	TOS100B42.2	TS100B42.2	100BA42.2	TOS100BA42.2	TS100BA42.2	100BW42.2	TOS100BW42.2	TS100BW42.2
3	100	100B43.7	TOS100B43.7	TS100B43.7	100BA43.7	TOS100BA43.7	TS100BA43.7	100BW43.7	TOS100BW43.7	TS100BW43.7
4	100	100B43.7H	TOS100B43.7H	TS100B43.7H	—	—	—	—	—	—
5	100	100B45.5	TOS100B45.5	TS100B45.5	—	—	—	—	—	—
6	100	100B47.5	TOS100B47.5	TS100B47.5	—	—	—	—	—	—



# 80 · 100 mm

## Dimensions

Free Standing

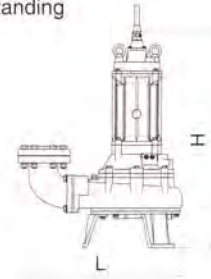

## Performance Curves

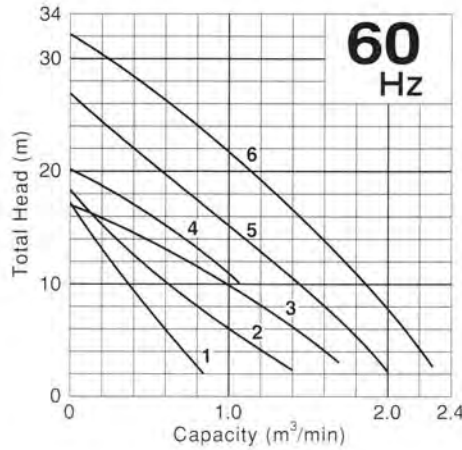
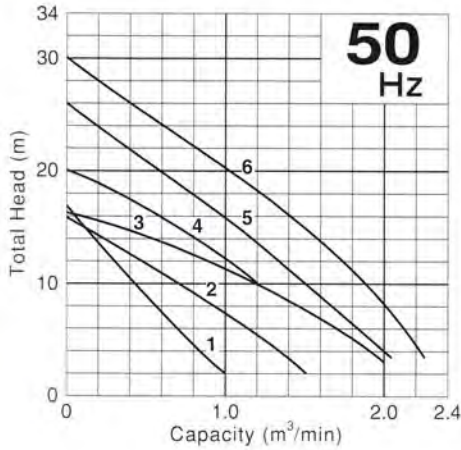

Guide Rail Fitting

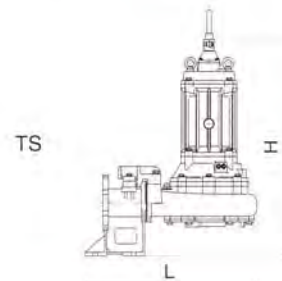
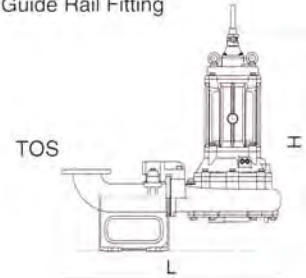

Motor Output kW	Phase	Revolution 50Hz/60Hz min <sup>-1</sup>	Starting Method	Impeller Passage 50Hz/60Hz mm	Standard Cable Length m	Cable Code	Dimensions L×H mm						Dry Weight kgs			
							Standard Model			Automatic & Auto-Alternation Model			Standard Model		Automatic & Auto-Alternation Model	
							Free Standing	Guide Rail Fitting		Free Standing	Guide Rail Fitting		Free Standing	Guide Rail Fitting ※	Free Standing	Guide Rail Fitting ※
								TOS	TS		TOS	TS				
0.4	Three	3000/3600	D.O.L.	35×22/ 35×18	6	A	347×443	563×478	333×477	—	—	—	25	24	—	—
0.75	Single	3000/3600	Capacitor	45×20/ 51×23	5	a	405×523	621×567	398×566	405×581	621×625	398×623	32	30	34	32
0.75	Three	3000/3600	D.O.L.	21×25	6	A	405×412	621×456	398×456	—	—	—	24	23	—	—
0.75	Three	3000/3600	D.O.L.	45×20/ 51×23	6	A	405×436	621×476	398×477	—	—	—	25	24	—	—

※Weights without duckfoot bend.

Motor Output kW	Phase	Revolution 50Hz/60Hz min <sup>-1</sup>	Starting Method	Impeller Passage 50Hz/60Hz mm	Standard Cable Length m	Cable Code	Dimensions L×H mm						Dry Weight kgs			
							Standard Model			Automatic & Auto-Alternation Model			Standard Model		Automatic & Auto-Alternation Model	
							Free Standing	Guide Rail Fitting		Free Standing	Guide Rail Fitting		Free Standing	Guide Rail Fitting ※	Free Standing	Guide Rail Fitting ※
								TOS	TS		TOS	TS				
1.5	Three	3000/3600	D.O.L.	49×41/ 49×35	6	A	446×536	668×586	515×586	457×630	679×680	526×680	36	34	40	38
2.2	Three	1500/1800	D.O.L.	47×53/ 47×46	6	B	596×616	754×631	599×631	596×733	754×748	599×748	68	64	78	74
3.7	Three	1500/1800	D.O.L.	81×53/ 81×47	6	B	602×690	760×700	605×700	602×863	760×873	605×874	84	80	94	90
3.7	Three	1500/1800	D.O.L.	35×62/ 35×55	6	B	596×666	754×681	599×681	—	—	—	81	77	—	—
5.5	Three	1500/1800	D.O.L.	40×51/ 40×43	8	D	687×908	905×906	709×906	—	—	—	149	142	—	—
7.5	Three	1500/1800	D.O.L.	40×61/ 40×54	8	E	687×929	905×927	709×927	—	—	—	162	155	—	—

※Weights without duckfoot bend.

Discharge Bore

# 200mm

## Performance Curves

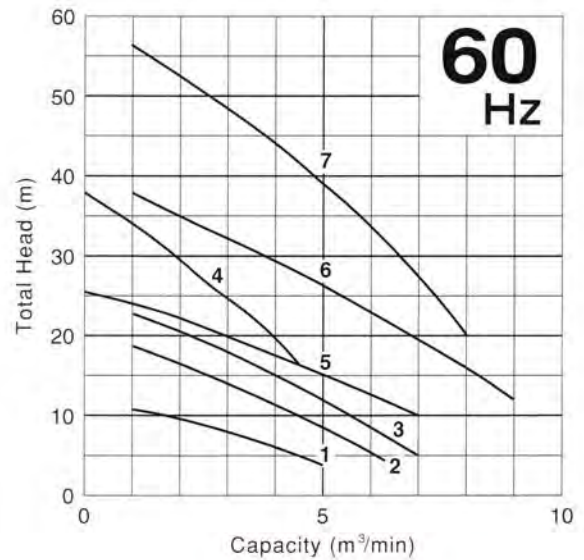
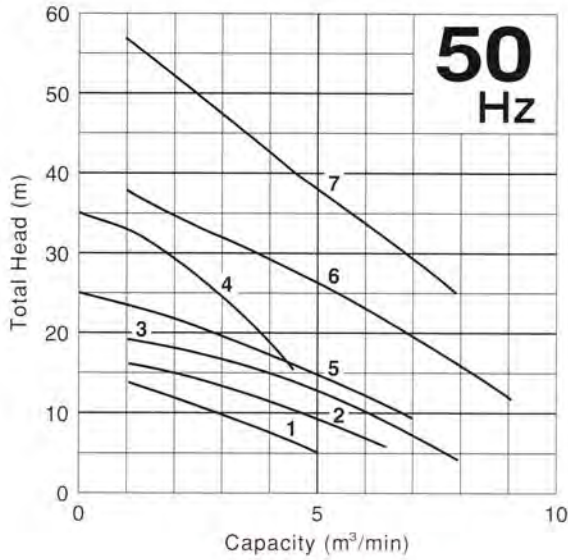

## Specifications

Curve No.	Discharge Bore mm	Model		Motor Output kW	Phase	Revolution 50Hz/60Hz min <sup>-1</sup>	Starting Method	Impeller Passage 50Hz/60Hz mm	Standard Cable Length m	Cable Code	Dimensions L×H mm		Dry Weight kgs	
		Free Standing	Guide Rail Fitting								Free Standing	Guide Rail Fitting	Free Standing	Guide Rail Fitting ※
1	200	200B47.5	TO200B47.5	7.5	Three	1500/1800	D.O.L.	80×60/ 100×50	8	E	926×1085	1263×1050	203	208
2	200	200B411	TO200B411	11	Three	1500/1800	Star-Delta	68×60/ 65×58	8	F	926×1131	1263×1096	252	257
3	200	200B415	TO200B415	15	Three	1500/1800	Star-Delta	70×60/ 69×60	8	G	971×1196	1235×1161	302	287
4	200	200B422H	TO200B422H	22	Three	1500/1800	Star-Delta	79×68/ 78×68	10	H	1043×1354	1375×1302	465	420
5	200	200B422	TO200B422	22	Three	1500/1800	Star-Delta	89×44/ 90×43	10	H	1088×1319	1356×1299	450	390
6	200	200B437	TO200B437	37	Three	1500/1800	Star-Delta	40×77	10	H	1190×1425	1428×1475	710	605
7	200	200B455	TO200B455	55	Three	1500/1800	Star-Delta	40×110/ 45×90	10	J	1185×1700	1466×1614	1060	1020

※Weights without duckfoot bend.

## Dimensions

Free Standing

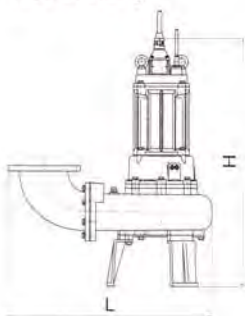

Guide Rail Fitting

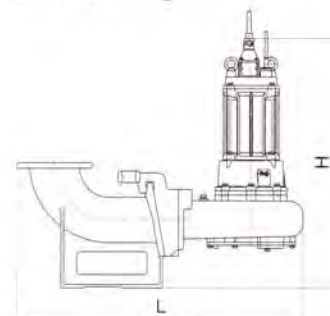



## Performance Curves

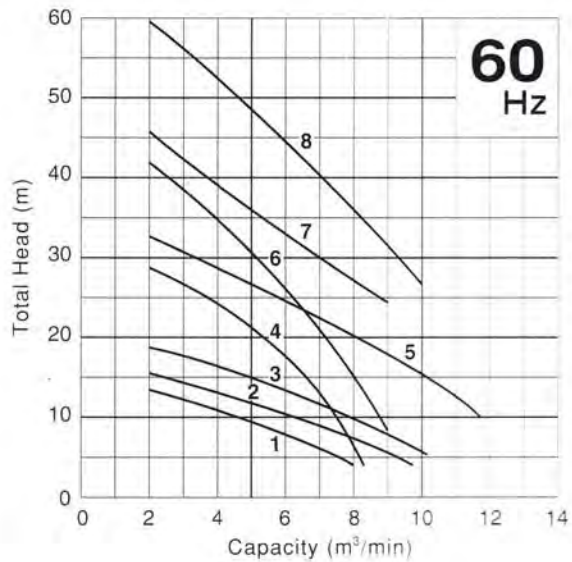
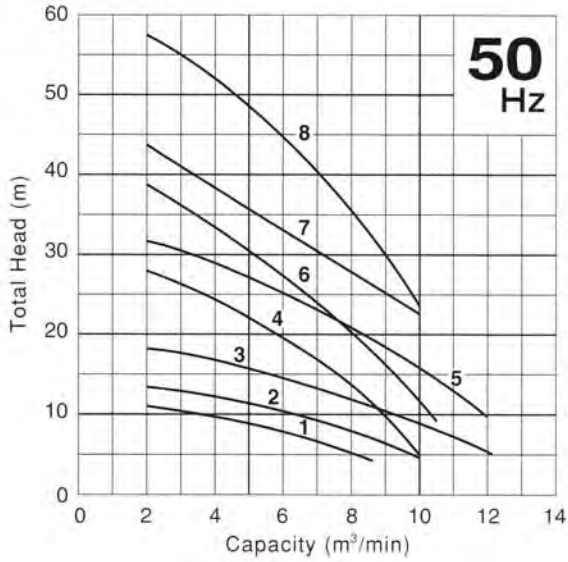

## Specifications

Curve No.	Discharge Bore mm	Model		Motor Output kW	Phase	Revolution 50Hz/60Hz min <sup>-1</sup>	Starting Method	Impeller Passage 50Hz/60Hz mm	Standard Cable Length m	Cable Code	Dimensions L×H mm		Dry Weight kgs	
		Free Standing	Guide Rail Fitting								Free Standing	Guide Rail Fitting	Free Standing	Guide Rail Fitting ※
1	250	250B611	TO250B611	11	Three	1000/1200	Star-Delta	80×68/ 80×58	8	L	1203×1211	1513×1166	430	390
2	250	250B415	TO250B415	15	Three	1500/1800	Star-Delta	79×46/ 85×36	8	G	1146×1228	1451×1194	420	380
3	250	250B622	TO250B622	22	Three	1000/1200	Star-Delta	90×90/ 96×76	10	H	1313×1617	1586×1556	735	630
4	250	250B430	TO250B430	30	Three	1500/1800	Star-Delta	75×80/ 76×76	10	H	1295×1564	1566×1497	730	610
5	250	250B437	TO250B437	37	Three	1500/1800	Star-Delta	63×80/ 65×76	10	H	1295×1592	1566×1525	765	640
6	250	250B445	TO250B445	45	Three	1500/1800	Star-Delta	45×70/ 45×68	10	H	1313×1664	1578×1605	780	680
7	250	250B455	TO250B455	55	Three	1500/1800	Star-Delta	45×70/ 45×68	10	J	1383×1700	1586×1635	1100	1040
8	250	250B475	TO250B475	75	Three	1500/1800	Star-Delta	35×75/ 35×78	10	J	1293×1700	1586×1635	1150	1090

※Weights without duckfoot bend.

## Dimensions

Free Standing

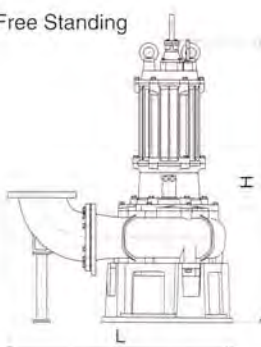

Guide Rail Fitting

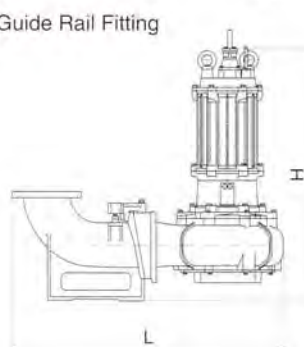



## Performance Curves

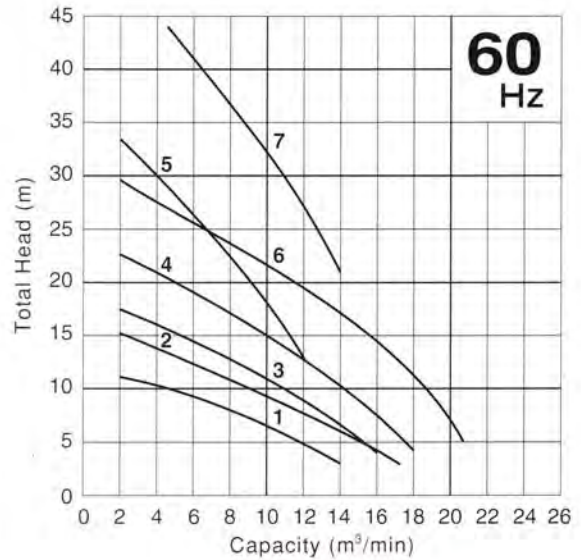
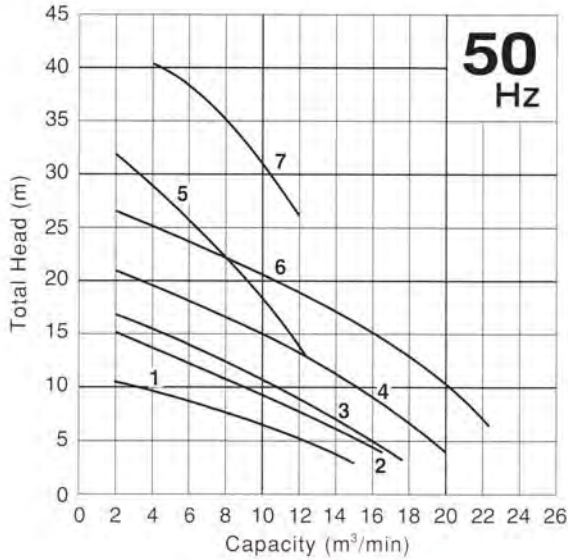

## Specifications

Curve No.	Discharge Bore mm	Model		Motor Output kW	Phase	Revolution 50Hz/60Hz min <sup>-1</sup>	Starting Method	Impeller Passage 50Hz/60Hz mm	Standard Cable Length m	Cable Code	Dimensions L×H mm		Dry Weight kgs	
		Free Standing	Guide Rail Fitting								Free Standing	Guide Rail Fitting	Free Standing	Guide Rail Fitting ※
1	300	300B615	TO300B615	15	Three	1000/1200	Star-Delta	140×90/ 140×60	8	M	1302×1314	1666×1274	550	520
2	300	300B622	TO300B622	22	Three	1000/1200	Star-Delta	140×76/ 127×76	10	H	1366×1626	1685×1629	790	685
3	300	300B630	TO300B630	30	Three	1000/1200	Star-Delta	130×115/ 140×76	10	H	1366×1654	1685×1657	815	685
4	300	300B637	TO300B637	37	Three	1000/1200	Star-Delta	140×100/ 140×65	10	H	1366×1716	1685×1719	850	725
5	300	300B445	TO300B445	45	Three	1500/1800	Star-Delta	60×90/ 70×76	10	H	1348×1713	1667×1694	870	740
6	300	300B655	TO300B655	55	Three	1000/1200	Star-Delta	105×90/ 110×90	10	J	1413×1833	1780×1766	1550	1500
7	300	300B475	TO300B475	75	Three	1500/1800	Star-Delta	60×80/ 65×90	10	J	1433×1700	1780×1666	1150	1100

※Weights without duckfoot bend.

## Dimensions

Free Standing

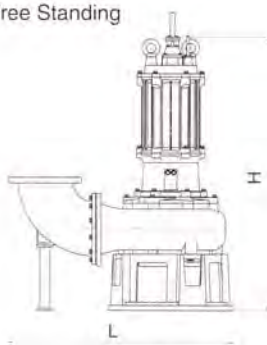

Guide Rail Fitting

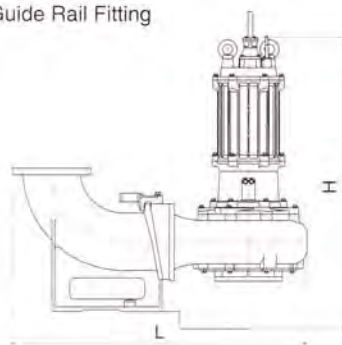



## Performance Curves

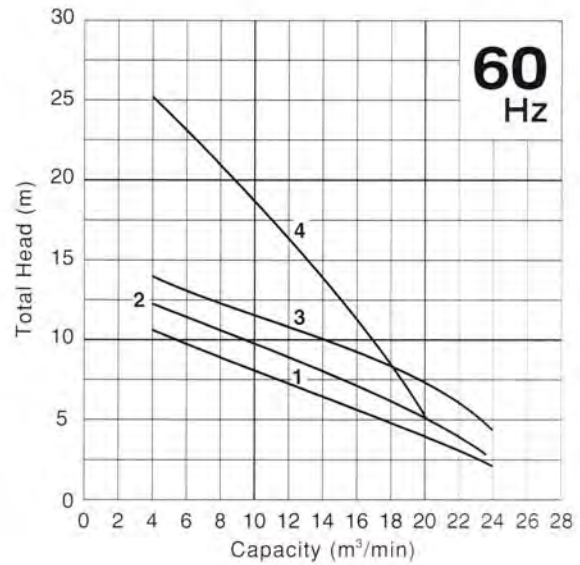
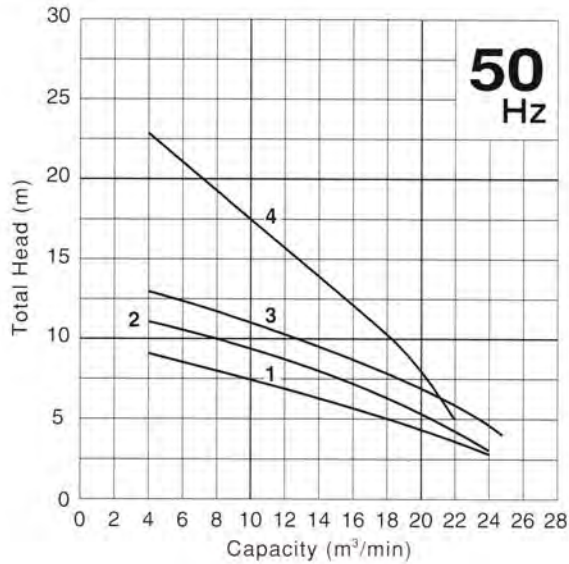

## Specifications

Curve No.	Discharge Bore mm	Model		Motor Output kW	Phase	Revolution 50Hz/60Hz min <sup>-1</sup>	Starting Method	Impeller Passage 50Hz/60Hz mm	Standard Cable Length m	Cable Code	Dimensions L×H mm		Dry Weight kgs	
		Free Standing	Guide Rail Fitting								Free Standing	Guide Rail Fitting	Free Standing	Guide Rail Fitting ※
1	350	350B822	TO350B822	22	Three	750/900	Star-Delta	156×100/ 160×90	10	H	1488×1713	1845×1728	965	815
2	350	350B630	TO350B630	30	Three	1000/1200	Star-Delta	190×95/ 200×70	10	H	1488×1694	1845×1709	920	770
3	350	350B637	TO350B637	37	Three	1000/1200	Star-Delta	190×130/ 200×100	10	H	1488×1756	1845×1771	970	815
4	350	350B645	TO350B645	45	Three	1000/1200	Star-Delta	130×90/ 140×78	10	H	1508×2026	1845×2049	1550	1395

※Weights without duckfoot bend.

## Dimensions

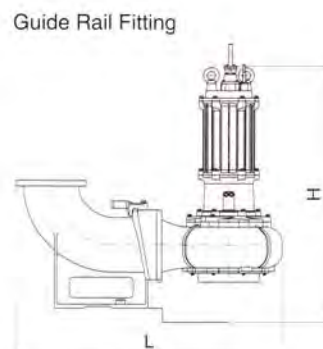
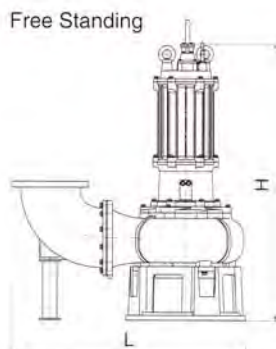



## Performance Curves

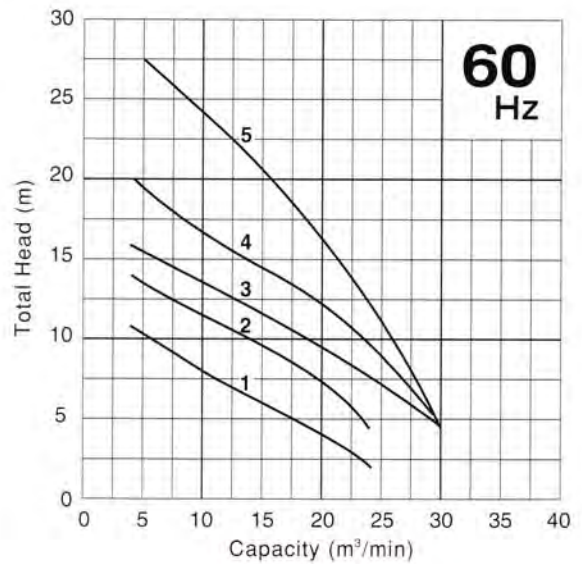
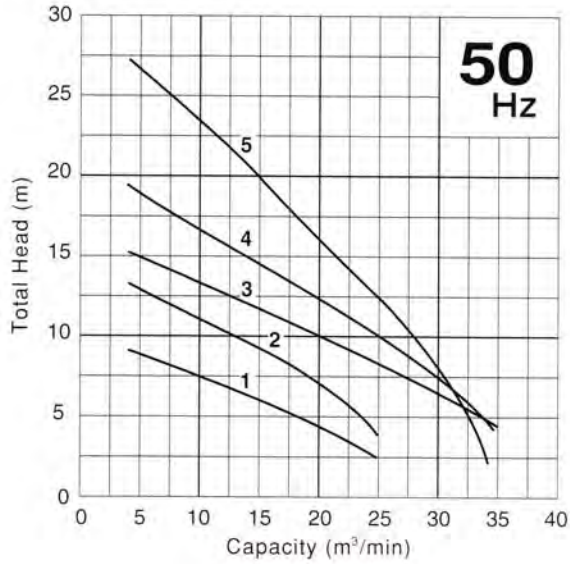

## Specifications

Curve No.	Discharge Bore mm	Model		Motor Output kW	Phase	Revolution 50Hz/60Hz min <sup>-1</sup>	Starting Method	Impeller Passage 50Hz/60Hz mm	Standard Cable Length m	Cable Code	Dimensions L×H mm		Dry Weight kgs	
		Free Standing	Guide Rail Fitting								Free Standing	Guide Rail Fitting ※		
1	400	400B822	TO400B822	22	Three	750/900	Star-Delta	156×109/ 160×90	10	H	1583×1713	2122×1788	985	920
2	400	400B637	TO400B637	37	Three	1000/1200	Star-Delta	190×130/ 200×100	10	H	1583×1756	2122×1831	990	955
3	400	400B645	TO400B645	45	Three	1000/1200	Star-Delta	175×128/ 175×100	10	H	1633×2030	2130×2158	1650	1580
4	400	400B655	TO400B655	55	Three	1000/1200	Star-Delta	145×110/ 175×100	10	J	1620×1878	2137×1970	1750	1700
5	400	400B675	TO400B675	75	Three	1000/1200	Star-Delta	130×100/ 140×90	10	J	1620×1878	2137×1970	1850	1800

※Weights without duckfoot bend.

## Dimensions

Free Standing

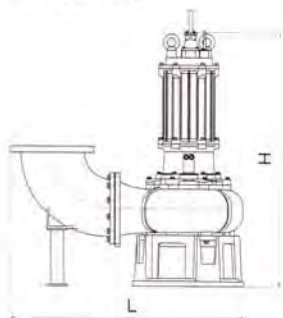

Guide Rail Fitting

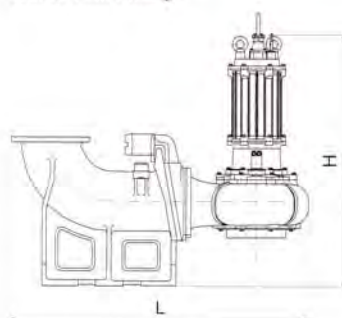



## Performance Curves

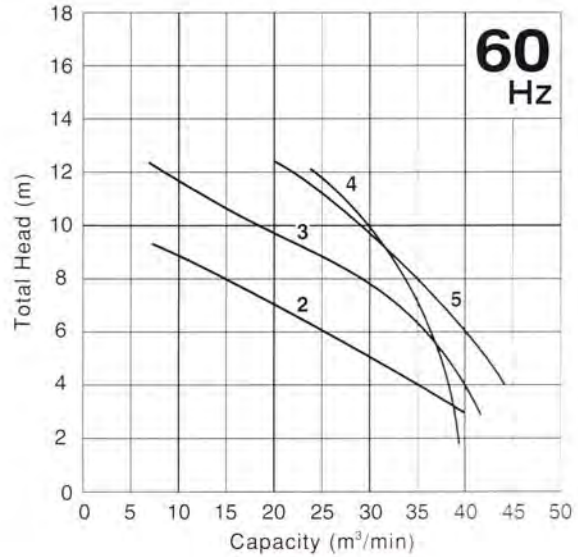
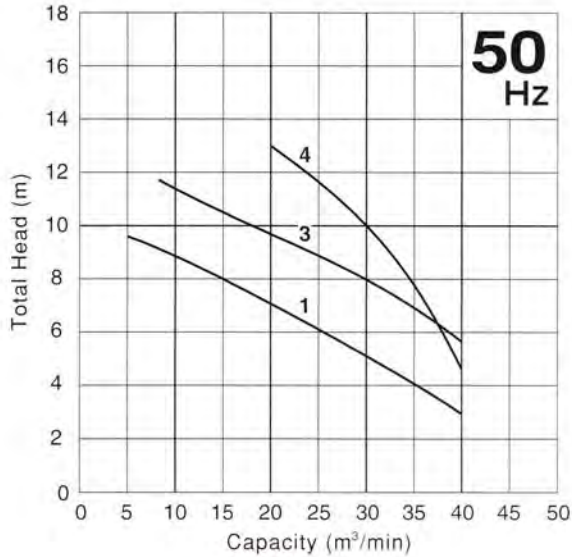

## Specifications

Curve No.	Discharge Bore mm	Model		Motor Output kW	Phase	Revolution 50Hz/60Hz min <sup>-1</sup>	Starting Method	Impeller Passage 50Hz/60Hz mm	Standard Cable Length m	Cable Code	Dimensions L×H mm		Dry Weight kgs		Frequency
		Free Standing	Guide Rail Fitting								Free Standing	Guide Rail Fitting ※			
1	500	500B1037	TO500B1037	37	Three	600	Star-Delta	225×100	10	J	2071×2080	2617×2182	2050	1950	50Hz only
2	500	500B1237	TO500B1237	37	Three	600	Star-Delta	225×100	10	J	2071×2080	2617×2182	2050	1950	60Hz only
3	500	500B855	TO500B855	55	Three	750/900	Star-Delta	175×140/ 175×80	10	J	2110×2080	2657×2225	2150	2050	50Hz/60Hz
4	500	500B675	TO500B675	75	Three	1000/1200	Star-Delta	130×120/ 130×100	10	J	2260×1990	2812×2160	2150	2050	50Hz/60Hz
5	500	500B875	TO500B875	75	Three	900	Star-Delta	190×80	10	J	2150×2694	2617×2334	2550	2450	60Hz only

※Weights without duckfoot bend.

## Dimensions

Free Standing

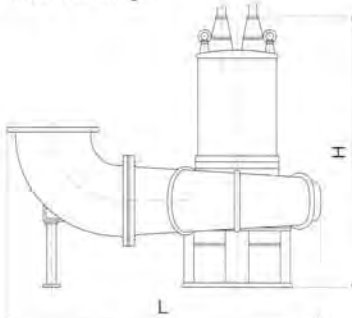

Guide Rail Fitting

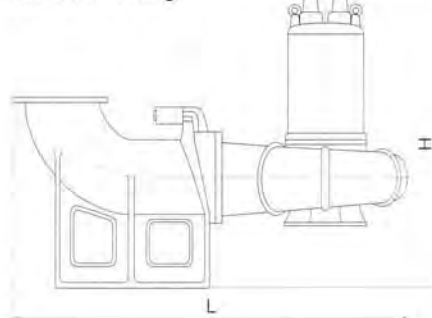



# 600 · 700 · 800 mm

## Performance Curves

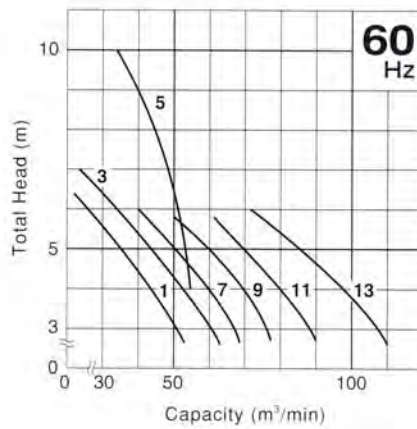
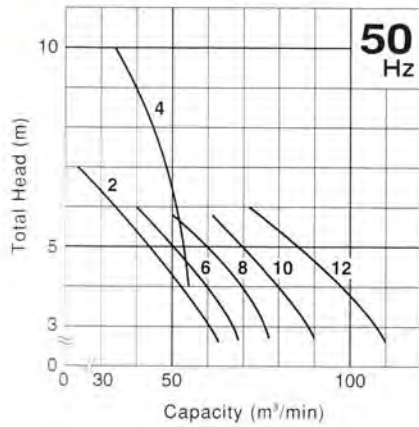

## Dimensions

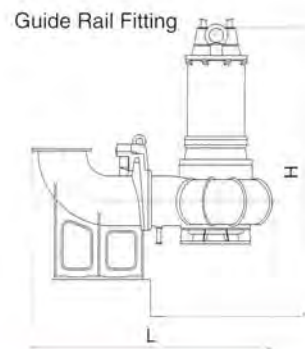

## Specifications

Curve No.	Discharge Bore mm	Model		Motor Output kW	Phase	Revolution 50Hz/60Hz min <sup>-1</sup>	Starting Method	Impeller Passage mm	Standard Cable Length m	Cable Code	Dimensions L × H mm		Dry Weight kgs		Frequency
		Free Standing	Guide Rail Fitting								Free Standing	Guide Rail Fitting	Free Standing	Guide Rail Fitting ※	
1	600	600B1845	TO600B1845	45	Three	400	Star-Delta	280 × 90	10	J	2522 × 3100	3062 × 3100	5000	5200	60Hz only
2	600	600B1255	TO600B1255	55	Three	500	Star-Delta	220 × 100	10	J	2522 × 3100	3062 × 3100	3150	3350	50Hz only
3	600	600B1455	TO600B1455	55	Three	514	Star-Delta	220 × 100	10	J	2522 × 3100	3062 × 3100	3150	3350	60Hz only
4	600	600B1085	TO600B1085	85	Three	600	Star-Delta	210 × 85	10	J	2468 × 3100	3008 × 3100	3100	3300	50Hz only
5	600	600B1285	TO600B1285	85	Three	600	Star-Delta	210 × 85	10	J	2468 × 3100	3008 × 3100	3100	3300	60Hz only
6	700	700B1265	TO700B1265	65	Three	500	Star-Delta	300 × 85	10	J	2840 × 3560	3440 × 3660	4000	4400	50Hz only
7	700	700B1465	TO700B1465	65	Three	514	Star-Delta	300 × 85	10	J	2840 × 3560	3440 × 3660	4000	4400	60Hz only
8	700	700B1275	TO700B1275	75	Three	500	Star-Delta	300 × 85	10	J	2840 × 3560	3440 × 3660	4200	4600	50Hz only
9	700	700B1475	TO700B1475	75	Three	514	Star-Delta	300 × 85	10	J	2840 × 3560	3440 × 3660	4200	4600	60Hz only
10	800	800B1290	TO800B1290	90	Three	500	Star-Delta	300 × 90	10	K	3053 × 3790	3623 × 3790	5600	5800	50Hz only
11	800	800B1490	TO800B1490	90	Three	514	Star-Delta	300 × 90	10	K	3053 × 3790	3623 × 3790	5600	5800	60Hz only
12	800	800B14110	TO800B14110	110	Three	428	Star-Delta	310 × 90	10	K	3053 × 3790	3623 × 3790	5800	6000	50Hz only
13	800	800B16110	TO800B16110	110	Three	450	Star-Delta	310 × 90	10	K	3053 × 3790	3623 × 3790	5800	6000	60Hz only

※Weights without duckfoot bend.



## CABTYRE CABLE CODE REFERENCE

### Single-Phase

Code	No. of Cables/ Pump Set	No. of Core & Area (mm <sup>2</sup> )	Outer Dia. (mm)	Material of Jacket
a	1	3×1.25	10.1	PVC

### Three-Phase

Code	No. of Cables/ Pump Set	No. of Core & Area (mm <sup>2</sup> )	Outer Dia. (mm)	Material of Jacket
A	1	4×1.25	11.1	PVC
B	1	4×2.0	11.8	PVC
C	1	4×3.5	15.8	Chloroprene Rubber
D	1	4×3.5	14.1	Chloroprene Rubber
E	1	4×5.5	16.8	Chloroprene Rubber
F	3	4×3.5	14.1	Chloroprene Rubber
		3×3.5	12.9	
		2×2.0	10.6	
G	3	4×5.5	16.8	Chloroprene Rubber
		3×5.5	15.2	
		2×2.0	10.6	

\*The cable designated in the specifications is that for 380 volts and higher use. A thicker cable may be used for 220 volts use

### Three-Phase

Code	No. of Cables/ Pump Set	No. of Core & Area (mm <sup>2</sup> )	Outer Dia. (mm)	Material of Jacket
H	3	4×14	21.7	Chloroprene Rubber
		3×14	19.7	
		3×2	12.2	
J	2	3×38	35.8	Chloroprene Rubber
		1×22		
		3×38	35.9	
K	2	3×60	45.7	Chloroprene Rubber
		1×22		
		3×2	45.7	
L	1	7×5.5	24.4	Chloroprene Rubber
		2×2.0		
M	1	7×8.0	24.4	Chloroprene Rubber
		2×2.0		

## TSURUMI OPTIONS

### SPECIAL VERSION WITH GALVANIC CORROSION PROTECTION

In sea water, the effect of galvanic corrosion is more serious than that of ordinary corrosion. When two kinds of metals are dipped into an electrolytic liquid, a battery phenomenon occurs due to the difference in the electric potential of the two metals. In this case, the metal having the higher potential corrodes first. As an option, Tsurumi can supply pumps with parts made of higher electric potential metal as the sacrificial anode.

### SPECIAL VERSION FOR HIGHER TEMPERATURE LIQUID

Standard pumps are designed for continuous running at the maximum ambient temperature of 40°C. In addition to these, Tsurumi can provide pumps for operation at higher liquid temperatures upon request. Refitting for operation at higher temperatures involves modification of not only the insulation of motor windings but also several components.

Two high-temperature operating models are available - the Rank 60 for operation in liquids up to 60°C and the Rank 90 for operation in liquids up to 90°C. Consult your dealer for more details. (These special versions are not available for some pump models.)

### SPECIAL VERSION WITH NON-STANDARD MATERIALS

Tsurumi can also provide you with pumps with essential components such as the impeller, pump casing, and the suction cover made of non-standard materials. Select from stainless-steel, chromium iron and bronze to suit your specific requirements. Consult your dealer for more details.

## SPECIAL ACCESSORIES

### FLOAT SWITCHES

Tsurumi offers two types of float switches (liquid level sensors). A micro-switch is incorporated in both types.

Model MC-2 is a heavy-duty type float switch with a shock absorber. Having equipped with a high grade micro switch, the MC-2 assures trouble-free operation in the liquid containing much suspended solids and floating scum. Either of the two contacts, normally-open or normally-close, can be selected as required.



Model RF-5 is an economy type float which can detect upper/lower-limit water levels with single float. The snap on-off action ensures stable operation in clean or waste water containing suspended solids or oil and fat.



We reserve the right to change the specifications and designs for improvement without prior notice.

**TSURUMI  
MANUFACTURING CO.,LTD.**

**PT. LUKES INDONESIA**

Lindeteves Trade Center Lt UG, Blok B1 No. 6  
Jalan Hayam Wuruk, Jakarta - Indonesia  
Phone : 021 - 6231 7842, 628 5144  
Fax : 021 - 6231 0499  
email : lukes@cbn.net.id

